



PURE

UPVC Windows & Doors



WINDOWS,
DOORS AND
CONSERVATORIES





PURE

UPVC Windows & Doors



Pure Windows is a local trade double glazing company with years of experience supplying and installing high quality uPVC Windows, Doors and Conservatories.

As a trade company supplying to over 1000 builders and developers, we offer extremely competitive prices on all of our products. Unlike other companies, we have no salesmen and therefore pay no commissions! We can also supply and install windows and doors in as little as 5 - 10 working days.

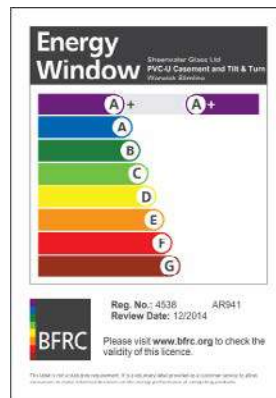

With exceptional levels of workmanship and a real touch on customer service, we have built an enviable reputation with hundreds of satisfied customers. As proud members of the Double Glazing Network, Pure are delighted to hold a number of industry-leading accreditations, as well as being one of the largest installers of Liniar uPVC windows and doors in the South of England.

Our Accreditations



Official Police Security Initiative



Call Us On: 023 8069 6300 Email: sales@purewindows.co.uk

Website: www.purewindows.co.uk





CONTENTS

Liniar	6	Doors	42
Welcome to Liniar	6	Entrance Doors	42
The Perfect Profile	7	Composite Doors	44
Guarantee	9	Back Doors	46
		Stable Doors	48
		French Doors	50
Energy Efficiency	10	Patio Doors	52
Better for the Environment	11	Bi-fold Doors	54
Energy Ratings	13	Door Accessories	56
		Door Letterboxes	57
		Yale Lockmaster™	58
Windows	14		
Hand Finishing	14	Conservatories	60
Casement Windows	16	Design Options	62
Security is our Priority	18	Roof Options	64
Hinge Options	20	Conservatory Process	66
Window Accessories	21		
Colour Options	22		
Bay and Bow Windows	24		
Flush Sash Windows	26		
Tilt and Turn Windows	28		
Vertical Sliders	30		
Sash Horn Windows	32		
French Casement Windows	34		
Glass	36		
Astragal Bar	36		
Triple Glazing	38		
Obscure Glass	40		

WELCOME TO



Enhance your home with the most technically advanced uPVC window system in the UK



Innovative

Liniar's ground breaking profile system has been designed from scratch, not only to meet the technical requirements of today, but also to provide innovative solutions to long standing product compromises.

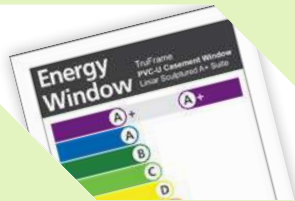

Energy Efficiency

Liniar window systems offer superior thermal efficiency as they are capable of achieving WER (Window Energy Ratings) A+12 or a U value as low as 1.0 W/(m²·K) with triple glazing.



British Engineering

Liniar design and manufacture all their products from a corporate headquarters located in Denby, Derbyshire. This advanced, purpose-built facility houses the largest uPVC extrusion mixing plant in all of Europe.



Environmentally Friendly

Liniar profiles are manufactured using 100% lead-free materials. The environmental dangers of lead are well known and providing a totally lead-free range of products substantially minimises environmental impact.



Guarantee

Liniar profiles come with a 10 year guarantee against cracking, warping or discolouration from the date of installation. You can rest assured that Liniar products are fully covered and built to last.

THE PERFECT PROFILE



1 Glazing flipper



Unique 'glazing flipper' gasket reduces cold transfer, water ingress and noise pollution.

2 Multi-chambered



Size-optimised chambers break up mini convection currents locking in pockets of warm air.

3 Superior gaskets



High performance (patented) double-action 'bubble' gaskets maintain tight weather seals.

4 Integrated reinforcing



Internal structures provide exceptional rigidity whilst minimising the need for steel reinforcing.

5 Positive drainage



Specially designed profile contours maximise natural drainage and prevent moisture build-up.

6 Thermal dam



Designed to Passivhaus recommendations, the thermal dam reduces heat transfer.

10 Year Product

Linlar profiles are manufactured using
formulations from approved suppliers and
or discolour

10 Year Product

Linlar profiles are manufactured using
formulations from approved suppliers and
or discolour for 10 years from date

This guarantee is issued in association
with our raw material suppliers
and based on proven technology
for UV stabilised products.

Further details, weathering
data and full conditions can be
supplied on request.

All products to be installed to
Linlar recommendations.



www.linlar.co.uk



GUARANTEE

Feel secure with a 10 year manufacturer's guarantee covering all of our products.

Liniar 10 Year Product Guarantee

Liniar products are manufactured using revolutionary technology from approved suppliers and will not warp, split or discolour for 10 years from date of installation.



ENERGY EFFICIENCY

Save energy - Save money.

OUTSIDE

Solar heat and light transfer

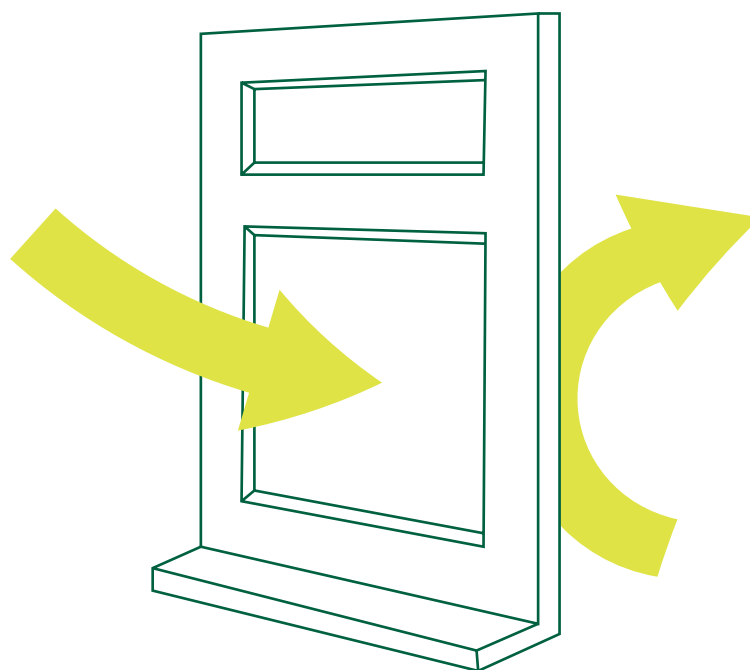

INSIDE

Heat reflected back in

Gain Free Solar Heat

Our energy efficient windows have a dual functionality that allows you to gain free energy from our greatest natural resource; the sun.

The tight weatherseals of the windows prevent cold wind and rain from entering your property whilst the glass allows natural free energy from the sun to enter and heat your home.

The glass of the windows has a transparent metallic coating that reflects heat back inside, retaining warmth and reducing the amount of energy needed to heat your home. Put simply, saving energy can save you money!

Cheaper Heating Bills

Our windows are capable of achieving an A+12 energy rating. This means your windows would retain an additional 12 kWh per m² each year over a standard A+0 rated window.

Compared with C rated windows you would save enough energy per year to run a full size A++ energy rated fridge freezer constantly and do a 2kg load of washing every other day for a year!

The calculations for this example are based on a property with 10 windows, each 1m². Assumptions are provided by information available on www.carbonfootprint.com and www.energysavingtrust.org.uk

BETTER FOR THE ENVIRONMENT

See how our windows build a greener future.

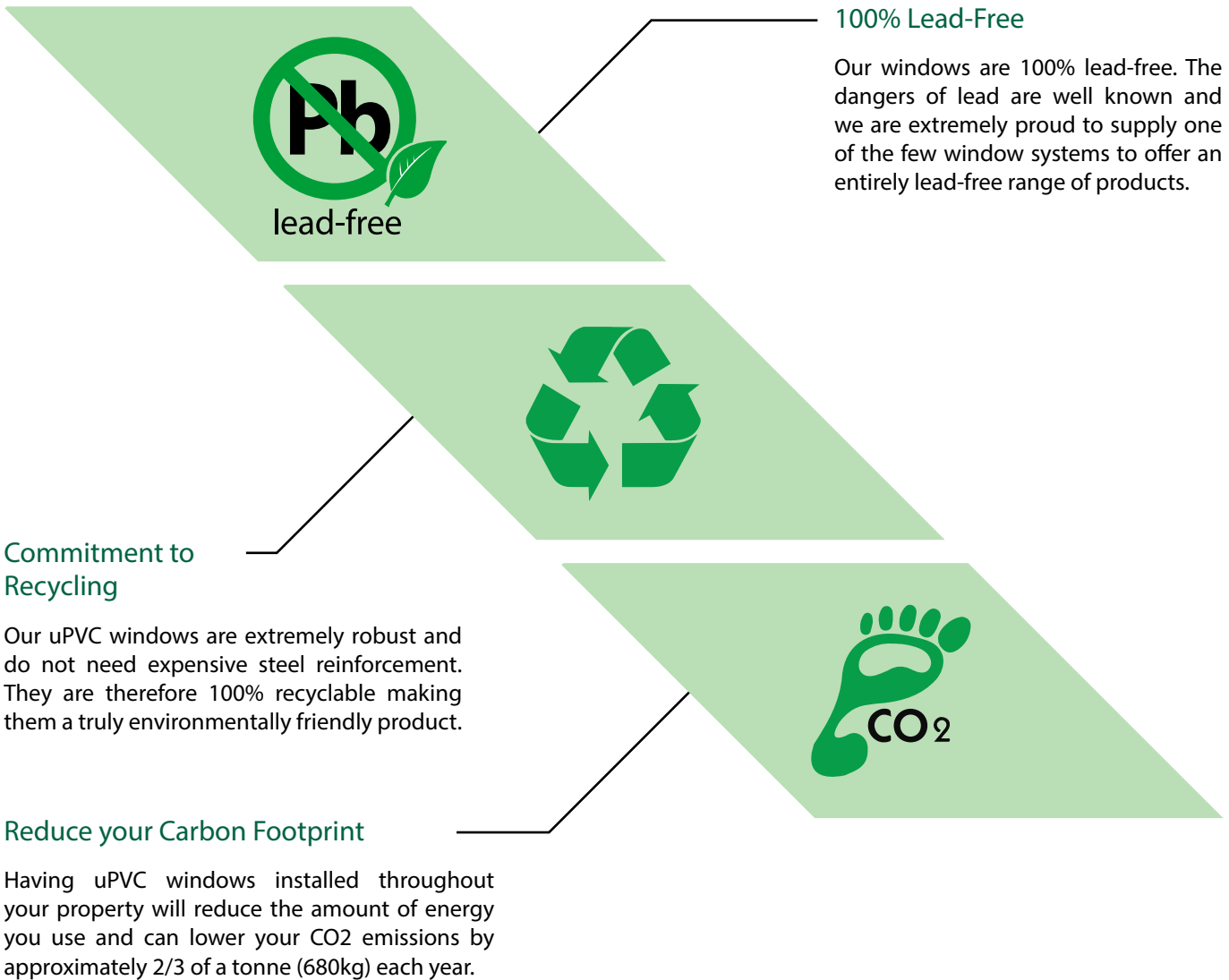



Energy Index (kWh/m²/year)
 (Energy Index certificate by BFRC and based on UK standard window. The actual energy consumption for a specific application will depend on the building, the local climate and the indoor temperature)

12

The Climate zone is

UK

Thermal Transmittance (U window) 1.3 W/m².K
 Solar Factor (g window) 0.47
 Effective Air Leakage (L factor) 0.00 W/m².K

M162



Reg. No.: 4413
 Review Date: 12/2013
 Please visit www.bfrc.org to check the validity of this licence.

This label is not a statutory requirement. It is a voluntary label provided as a customer service to allow consumers to make informed decisions on the energy performance of competing products.



This label is not a statutory requirement. It is a voluntary label provided as a customer service to allow consumers to make informed decisions on the energy performance of competing products.



ENERGY RATINGS

Endorsed by the industry's energy specialists.

What Are Energy Ratings?

In 2004 Window Energy Ratings (WER) were introduced by the British Fenestration Ratings Council (BFRC) in order to simplify the method of comparing the energy efficiency of windows.

The energy rating of the window, described as a letter from A (best) to G (worst), is determined by the amount of energy the product will either lose or supply to the property over the course of a year.



BFRC

The BFRC (British Fenestration Rating Council) runs the Window Energy Ratings (WER) scheme. We are proud to say that our energy efficient uPVC windows are all BFRC approved.



WER (Window Energy Ratings)

The WER system uses a rainbow coloured scale to show the energy efficiency a window provides. Our windows are capable of achieving an A+12 rating, the highest level of energy efficiency.



Energy Saving Trust

Our uPVC windows are endorsed to display the 'Energy Saving Recommended' logo. Only products that meet strict energy efficiency criteria are eligible to display this label.

HAND FINISHING

All Liniar uPVC frames are hand-finished by skilled craftsmen ensuring an exemplary high quality finish.

Step 1

All corner contours are checked for appearance and refinished by hand using precision chisels to guarantee a smooth finish.



Step 2

The outside edges are levelled at the corners, using engineered contour blocks, to maintain the sash's square silhouette once hung into the frame.

THE PROCESS

There should always be a high level of craftsmanship involved when making a made-to-measure product, which is why we insist that each frame and sash undergoes a rigorous hand finishing procedure.

Step 3

To maintain uniformity, each corner groove is checked for an even depth and manually deepened if found to be too shallow.



Step 4

All apertures are inspected for weld build-up in the corners, with any protrusion removed to ensure tight weather seals.



CASEMENT WINDOWS

Stylish, Secure and Energy Efficient

THE ULTIMATE WINDOW



1 Durable Hardware



Stainless steel friction stays provide enhanced security and have been tested to 20,000 cycles.

2 Chamfered Rebate



Choose a chamfered rebate detail for a simpler and more contemporary look.

3 Secured by Yale



Yale high security shootbolt locking system carries Yale's 10 year insurance backed guarantee.

4 Hinge Protection



Stay Guard Elite device withstands twice the force required by Secured By Design testing.

5 Slim Sightlines



Ultra slim sightlines allow for a larger area of visible glass, providing more light and enhanced views.

6 A+ Energy Rated



Liniar's state of the art window system is engineered to be capable of achieving a WER of A+12.



SECURITY IS OUR PRIORITY

Feel safe and secure with Yale, the world's favourite lock manufacturer.



The Yale Shootbolt Window Lock

All our Liniar windows are available with optional Yale shootbolt high security locking systems.

1 10 Year Mechanical Guarantee

Every Yale shootbolt window locking system is guaranteed against mechanical failure for 10 years after installation.

2 £1,000 Security Guarantee

The Yale shootbolt locking system Security Guarantee means you will receive up to £1,000 towards home contents insurance in the unlikely event of a break in.

3 Secured by Design Accredited

The Yale shootbolt locking system has been accredited with Secured by Design police preferred specification, the highest possible level of protection against forced entry.

4 British Standards Institute Specification

All components are designed and manufactured to the highest standards and tested to the latest BSI security criteria pertaining to windows and doors.





the world's favourite lock since 1842

APPROVED INSTALLER

This is to certify that
ABC Windows Ltd
is an approved installer of Yale
high security window and door locks

Yale are confident that windows and doors installed by the aforementioned company, when fitted with Yale high security window and door locks, will resist forced entry. In the unlikely event of this happening, Yale agree to cover any insurance excess payable under the homeowner's contents insurance policy up to a maximum of £1,000. For full terms and conditions see the Yale Security Guarantee.

Signed on behalf of TruFrame

David Firminger - Managing Director

Signed on behalf of Yale

Paul Atkinson - Sales Director

Yale Door and Window Solutions
School Street, Willenhall, West Midlands WV13 9PP

An ASSA ABLOY Group brand

10 Year
Security
Guarantee



THE WORLD'S FAVOURITE

By partnering with Yale, we give you total security and complete peace of mind.

HINGE OPTIONS

Choose from a range of hinge options to suit your own specific requirements.

Standard Hinge

Our standard hinges are manufactured exclusively in Britain from highly durable stainless steel. They offer superb anti-corrosion qualities and are available with an optional austenitic finish for additional corrosion protection for properties located on or near the coastline.



Egress (Fire) Hinge

Just like standard hinges, our egress hinge provides smooth and trouble-free operation for the duration of the product lifecycle, with the added benefit of optimised stay arm geometry. This provides an increased clear opening area to escape through in the event of a fire.



Easy Clean Hinge

As the name suggests, easy clean hinges provide access to both faces of the window so that cleaning is easy and hassle free, whilst providing the same safety benefits of an egress hinge. This is a particularly well-suited option for properties where the outside of the window is hard to reach.



Mega Egress Hinge

Our highest specification friction stay, the 'Mega' egress hinge incorporates the features of all other hinge types, whilst having a much higher load-bearing capacity. Specifying this hinge is a necessity when opting for triple glazing, due to the additional weight of the 3rd pane of glass.



WINDOW ACCESSORIES

Handle Colours

Window handles are available in a range of colours so that you can achieve your desired look.



Trickle Vents

As the name suggests trickle vents provide extra ventilation. They are seamlessly integrated into the frames of uPVC windows and can be opened or closed to control airflow in a property. Building Regulations stipulate that trickle vents are a requirement if the new window replaces a window where a trickle vent already exists. It is also considered best practice if the windows are to be installed in a habitable room.



PROFILE COLOUR OPTIONS

Choose from a wide range of colours to best complement your property and indulge your personal taste.



White



Ivory



Mahogany



Golden Oak

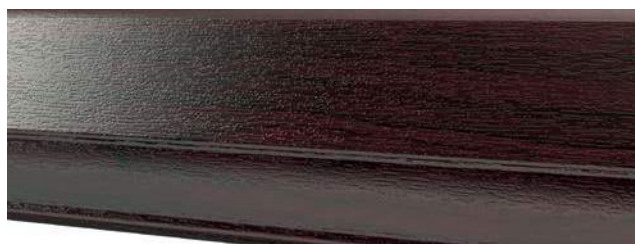

Rosewood



Cream Foil



White Foil



Black Foil



Irish Oak



Cedarwood



Light Grey



Dark Grey



Basalt



Grained Anthracite



Matt Anthracite



Dark Red



Burgundy

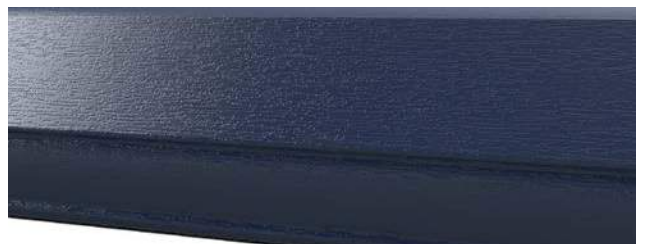

Dark Blue



Chartwell Green

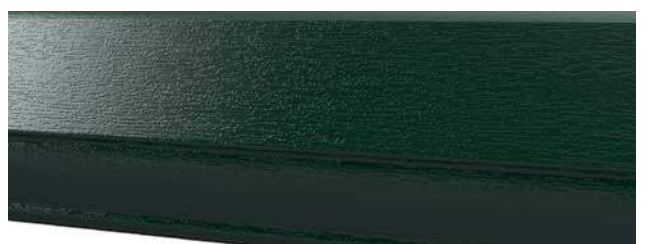

Dark Green



BAY AND BOW WINDOWS

Add character to your home with our beautiful bay and bow windows.

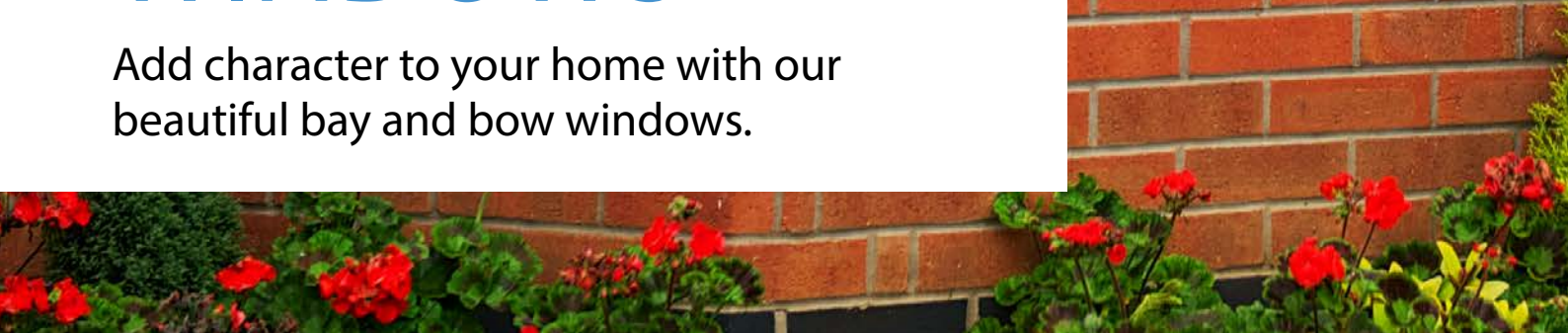



ENHANCE YOUR VIEW

Contemporary Design

Conservative trim detailing preserves period charm with an attractive, yet subtle, modern twist.

Equal Glass Area

Additional 'dummy sashes' create equal sightlines, enhancing the appearance of your home.

Bow Bay Conversion

Transform a flat window into a beautiful bow bay and create a heightened sense of space.

Structural Bay Poles

Bay poles can be carried through the cill onto a hidden bearing plate to take structural loads.

Joint Couplings

Clever interior and exterior joint couplings prevents dust forming to make upkeep easy.

Welded One-Piece Cill

The external cill is welded together to create a single cill underneath all of the uPVC frames.



FLUSH SASH WINDOWS

The attractive, low maintenance
and thermally efficient timber alternative.

PERFECTLY DESIGNED

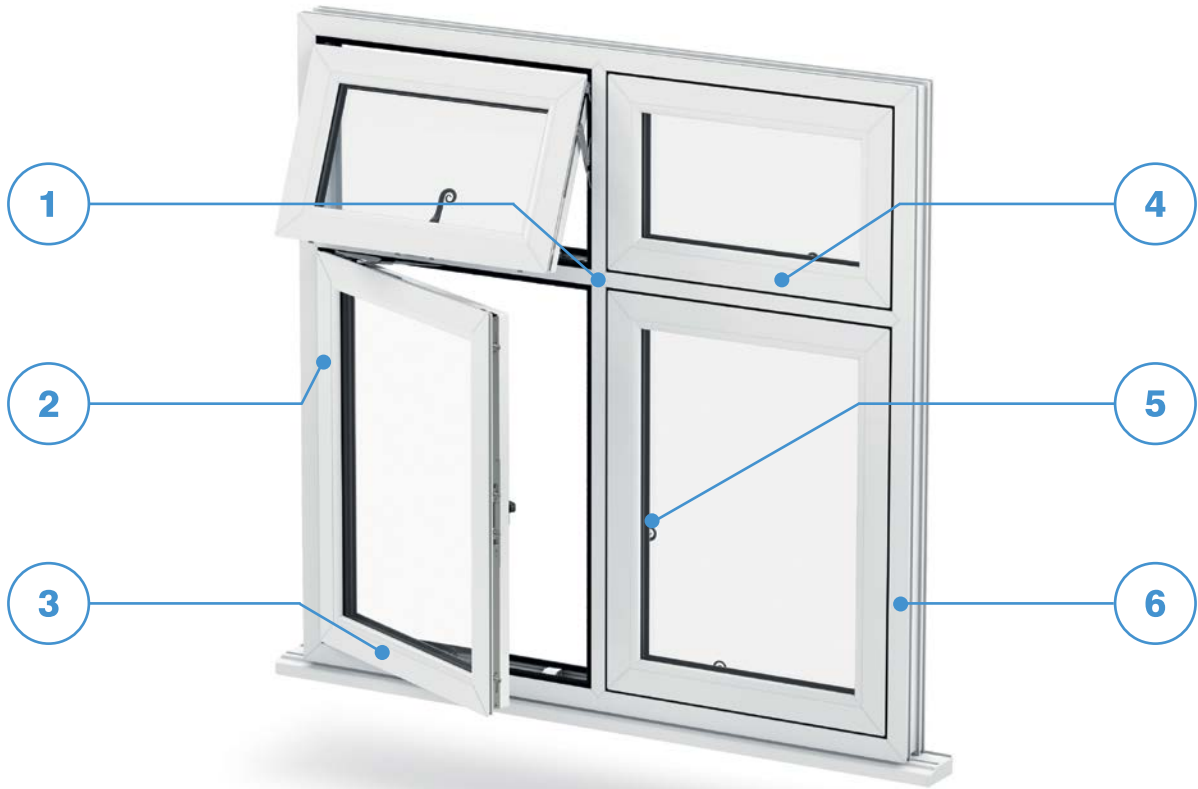

1 Beautiful Aesthetics



Inspired by traditional timber joinery, the frame and sash sit flush when closed.

2 Energy Efficient



Manufactured using multi-chambered 100% lead-free Liniar Energy Plus uPVC profile.

3 Low Maintenance



The traditional look of timber without the maintenance. You'll never need to sand, treat or paint them.

4 Traditional or Contemporary



Flush sash windows look stunning in period properties and contemporary homes alike.

5 Additional Hardware



Customise with traditional monkey tail handles and dummy stays or sleek modern handles.

6 Hand Finished



Flawlessly manufactured, hand finished and quality checked by highly trained craftspeople.



TILT AND TURN WINDOWS

Versatile tilt and turn windows are both attractive and functional.

SAFE AND SECURE



1 Secure Ventilation



Convenient 'tilt-only' function provides additional ventilation without compromising security.

2 Integrated Hardware



UNI-JET concealed gearing is better looking and more secure than outdated face-fix gearing.

3 European Aesthetic



Clean straight lines and crisp, concise detailing combine with fully integrated hardware.

4 Corrosion Resistance



'FerGUard*silver' surface coating ensures long-term corrosion protection at no extra cost.

5 Quick-To-Clean



90° turn action allows easy exterior access, ideal for upstairs windows or high-rise accommodation.

6 Uninterrupted Seal



A continuous rebate gasket prevents condensation whilst enhancing sound-proofing.



VERTICAL SLIDERS

Maintain a traditional look for your home with our elegant uPVC vertical sliding sash windows.

A MODERN CLASSIC

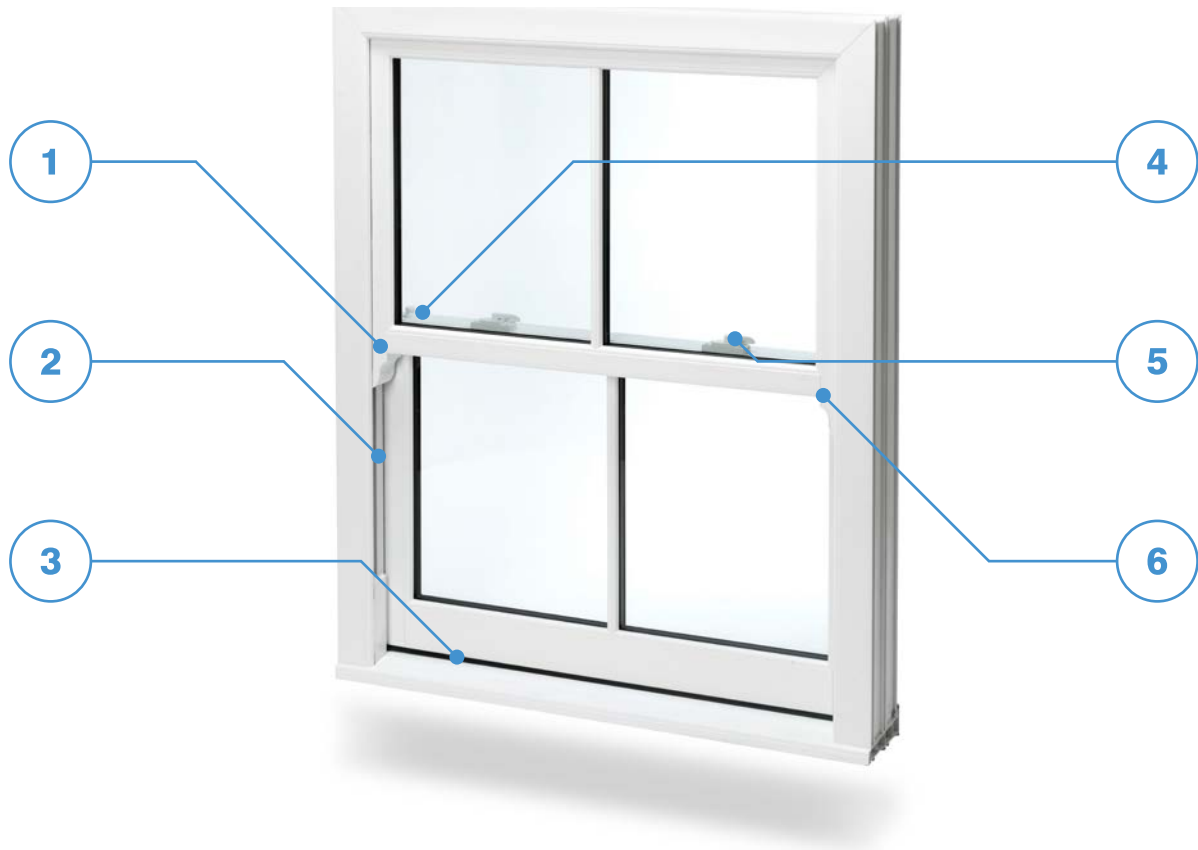

1 Sash Horns



Optional decorative sash horns enhance the traditional look of your uPVC sliding sash windows.

2 Spring Balance Mechanism



Spiral balances counteract the weight of the sliding sash for smooth and effortless operation.

3 Concealed Gaskets



Low-level PCE gaskets provide protection from the elements whilst remaining out of view.

4 Keep Children Safe



Restrictors can be fitted to stop the bottom sash sliding fully, keeping your children safe.

5 High Security



uPVC vertical sliding sash windows are available with high security cam locks for your peace of mind.

6 Tilt Function



Built in pivot bar enables sashes to tilt inwards for cleaning or extra ventilation at the push of a button.



SASH HORN WINDOWS

The refined alternative to
sliding sash windows.

TRADITIONAL STYLE

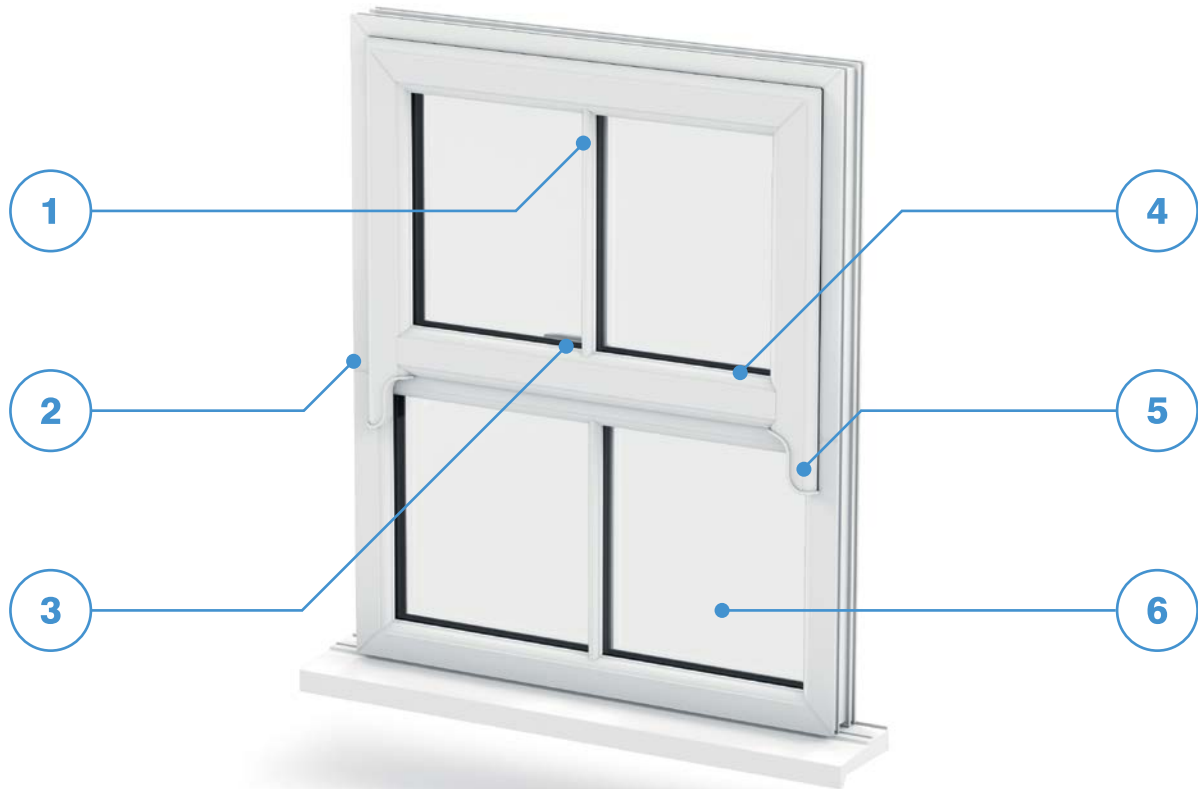

1 Authentic Looks



Preserve the look of wooden box sash windows and maintain the integrity of your property.

2 Hand Finishing



Every window undergoes stringent hand finishing for an unrivalled level of product quality.

3 Security Assured



Windows with Yale shootbolt locking are covered by a money-back promise in the event of a break in.

4 Yale 10 Year Guarantee



Yale shootbolt locking systems are guaranteed against mechanical failure for 10 years.

5 Integrated Horns



Our sash horns are a single piece of uPVC for a better look than screw-on alternatives.

6 Superior Weather Sealing



Continuous sash seal (incorporating special horn gaskets) gives protection against the harshest conditions.



FRENCH CASEMENT WINDOWS

Really open up your property with our beautiful French casement windows.

A WIDER VIEW



1 Flying Mullion



When opened fully, one sash carries the central mullion for a completely unrestricted view.

2 Controlled Ventilation



The master sash can be opened independently from the slave sash for variable ventilation.

3 90° Hinge Opening



Sashes can open a full 90°, creating a greater feeling of space whilst letting in more light.

4 Fire Escape



French casements are Part B* compliant, ideal for narrow openings that need to be fire escapes.

5 Environmentally Friendly



Like all our uPVC products, French casements are 100% lead-free and 100% recyclable.

6 Easy to Clean



Easy-clean hinge option makes our French casement windows extremely low maintenance.

* Building Regulations 2010, Approved Document B (Fire Safety) pertaining to work carried out in England.

ASTRAGAL BAR

Put your own personal stamp on your windows.

What are they and how do they work?

Design & Consultation

A member of our team will talk through the astragal bar arrangement with you to ensure that the layout is complementary to your chosen window style and the look of your property. This is then turned into an electronic 'schematic' drawing used for the manufacture of the windows.



Manufacture

During manufacture, a grid of rigid plastic or aluminium spacer bars is positioned within the sealed units of the windows and securely held in place by concealed fixings. The grid is sandwiched between the two panes of glass and the unit is then sealed air-tight.



Finished Product

Decorative uPVC bars are then applied to the internal and external faces of the window so that the surface of the glass underneath becomes hidden from view and the bars appear to intersect through the entire window. This creates the illusion of many smaller individual panes, replicating the look of a traditional Georgian window.



AUTHENTIC LOOK

Nothing compares to the genuine look and feel of well executed Astragal and Georgian bars.



Astragal Bar

We use environmentally friendly 20mm Liniar profile for our astragal bars which like all our uPVC window frames is 100% lead-free and 100% recyclable.

Run through mullion sections and extremely precise end-milling creates an aesthetic which faithfully replicates the look of real wood without any of the upkeep.



Georgian Bar

The ever-popular Georgian bars option will add to your windows an air of sophistication.

The bars sit within the sealed glass unit to provide an elegant and refined look. Georgian bars are an attractive and economic alternative to astragal bars.

TRIPLE GLAZING

The only uPVC window specifically designed for triple glazing.

Triple glazing will significantly improve the thermal efficiency and sound insulation of your home. With three unique features, we offer the only UK window profile system specifically designed for triple glazing.

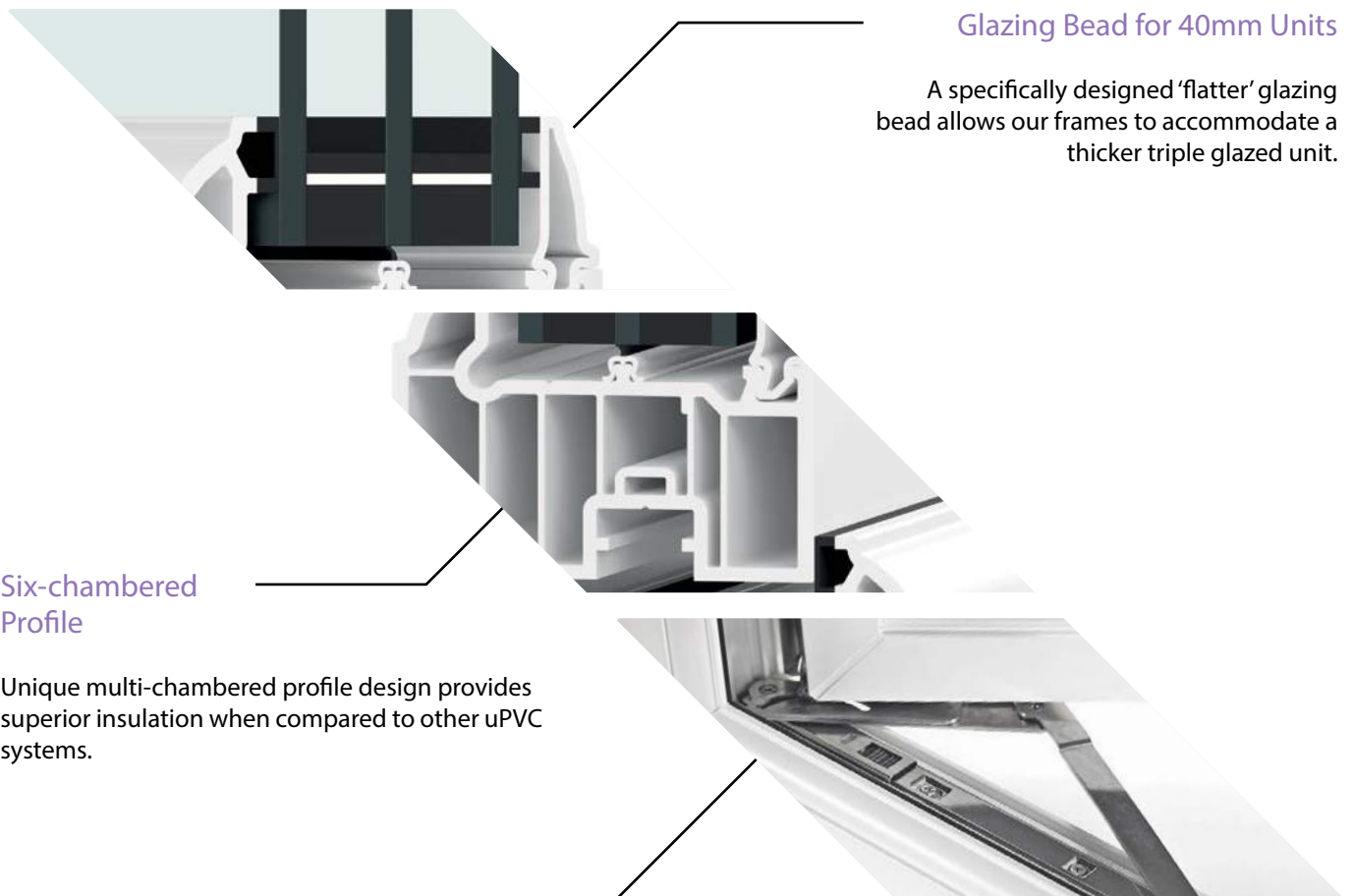

Glazing Bead for 40mm Units

A specifically designed 'flatter' glazing bead allows our frames to accommodate a thicker triple glazed unit.

Six-chambered Profile

Unique multi-chambered profile design provides superior insulation when compared to other uPVC systems.

Trojan 'Mega' Hinge

Our Trojan 'Mega' egress hinge is larger and stronger than standard, making them ideal for triple glazing.

TRIPLE THE BENEFITS



1 Enhanced Security

A third pane of glass provides an extra layer of defence against an attempt to break in.

2 Noise Reduction

A second unit cavity makes sound wave transfer more difficult, providing superior noise reduction.

3 Energy Retention

With the 40mm glazing bead, our triple glazed units can achieve U-values as low as $1.0 \text{ W}/(\text{m}^2\text{-K})$.

OBSCURE GLASS

Achieve the level of privacy you desire.

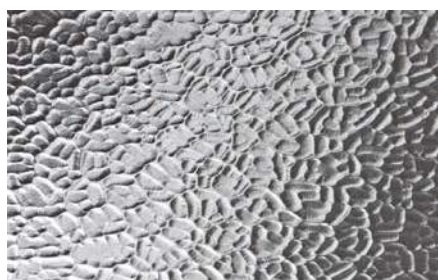

Arctic™

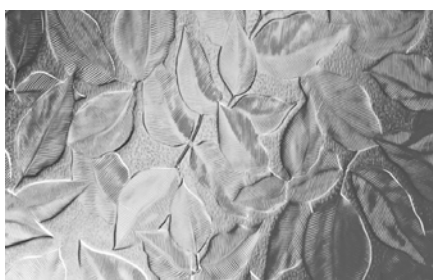

Autumn™

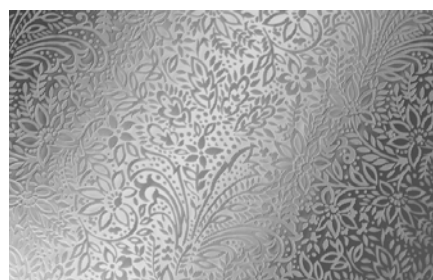

Chantilly™

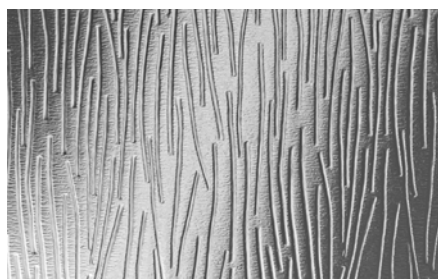

Charcoal Sticks™



Contora™



Cotswold™

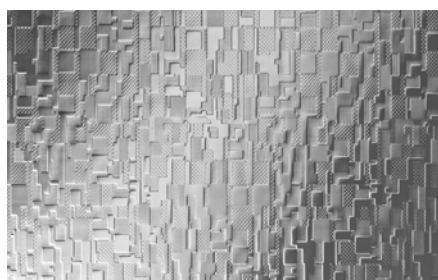

Digital™



Everglade™



Flemish™



PILKINGTON

If you are looking for extra privacy but don't want to lose light within your rooms then obscure glass is the solution. There is a wide range of obscure glass options available to give you the exact level of privacy you require.

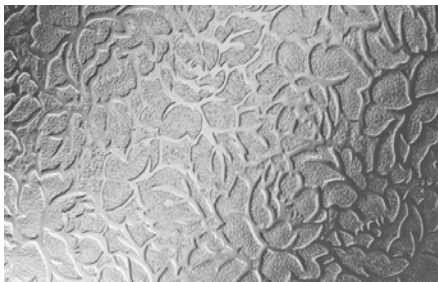

Florielle™



Mayflower™

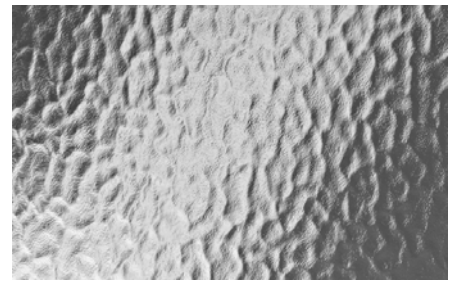

Minster™

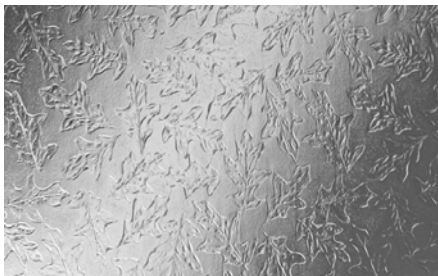

Oak™



Pelerine™



Stippolyte™



Sycamore™



Taffeta™

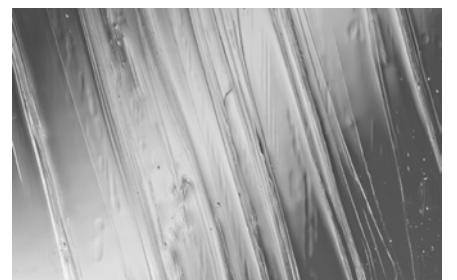

Warwick™

Each pattern brand name is a trademark of Pilkington PLC | Images may only be reproduced by permission of Pilkington PLC |
All images are copyright of Pilkington PLC



ENTRANCE DOORS

Gain security, weather-proofing and durability with a uPVC entrance door.

MAKE AN IMPACT

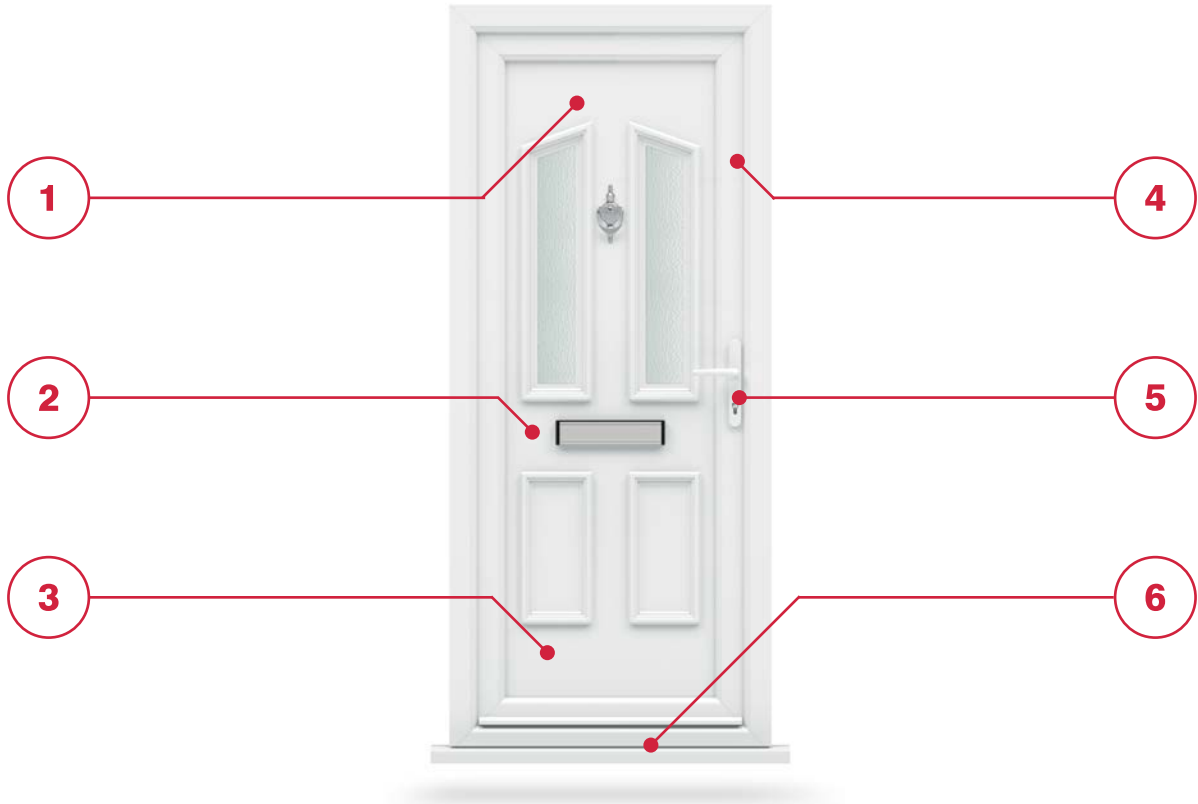

1 Unbeatable Choice



Style your door to your own personal taste with our wide range of panel designs and glazing options.

2 Secured By Design



The optional 'SBD Accredited' pack for the ultimate in door security is available on all our doors.

3 Insurance Backed



Our doors come with the promise of £1,000 towards your contents policy in the unlikely event of a break in.

4 Double Rebated



Outer frame profiles feature a double rebated design for extra defence against Mother Nature.

5 Britain's Favourite Lock



Yale Lockmaster® multipoint locks, the UK's top selling door lock, are fitted into every single door we make.

6 Threshold Options



Choose from standard or low uPVC threshold, or a standard or Part M* compliant aluminium threshold.

* Building Regulations 2010, Approved Document M (Access to and use of buildings) pertaining to work carried out in England.



COMPOSITE DOORS

Make a lasting impression with
an elegant composite door.



ELEGANT & STRONG

Timeless Design

Our exceptional range of composite doors reproduces the traditional form of timber products.

Express Yourself

Achieve exactly the look you desire with our vast selection of colourways and style options.

Maximum Security

The high security locking systems found in our doors promise to offer you the very best in home protection.

Resilient

Built from a variety of modern materials, composite doors are hard-wearing and long-lasting.

Low Maintenance

Easy to maintain as they don't need painting! They're also guaranteed not to rot or warp.

Weather Resistant

Designed to keep the cold and rain out and the warmth generated by your home's central heating locked-in.



BACK DOORS

Our back doors provide security,
functionality and weather-sealing.

INCREDIBLY ROBUST

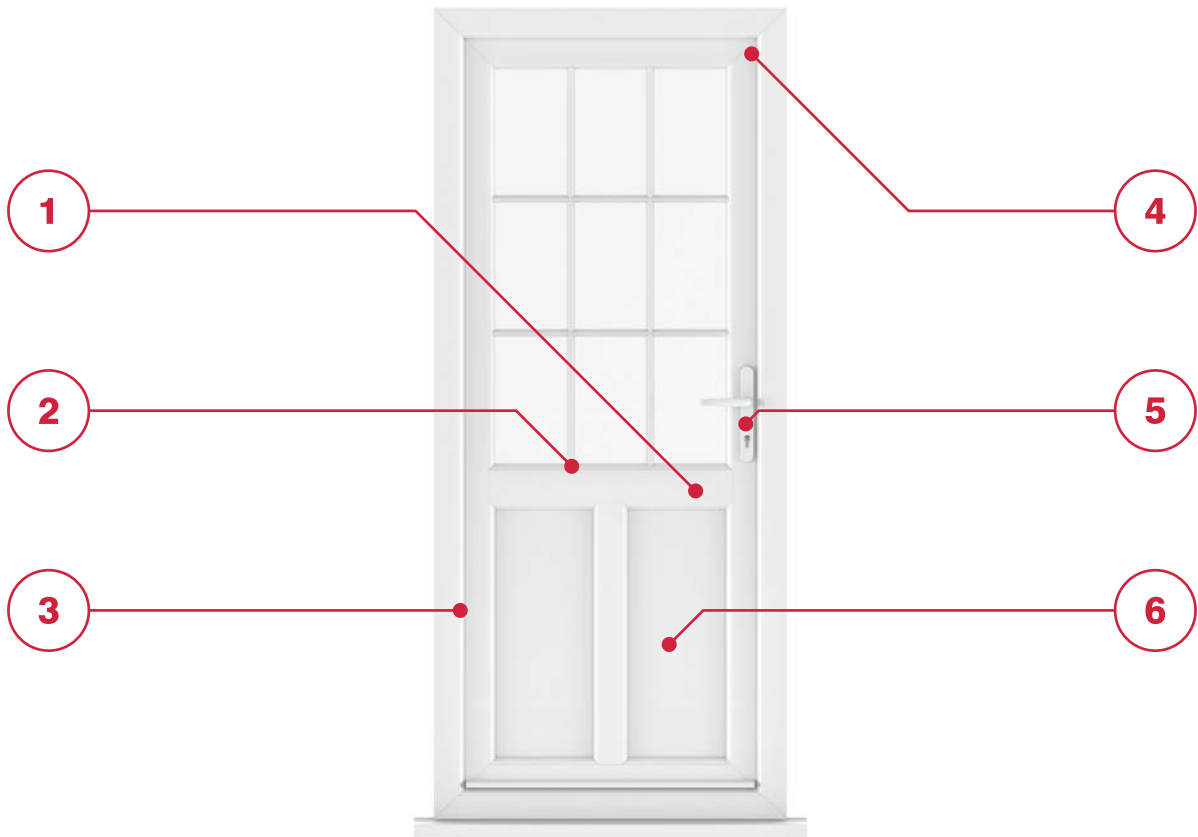

1 Panic Door System



Our push bar panic doors are ideal for domestic situations requiring an emergency escape.

2 Universal Rebate



A common rebate detail on all products means doors can have our astragal bar glass decoration too!

3 Superior Sealing



Our back doors have superior gaskets, providing protection from the harshest of weather conditions.

4 Hand Finished



Our back doors are carefully hand finished by skilled craftsmen for an unbeatable, high quality aesthetic.

5 Yale Guarantee



All doors fitted with Yale Lockmaster® are guaranteed against mechanical failure for 10 years.

6 Panel Choices



Choose from a range of raised half, quarter and flat panels with fully integrated pet entrance options.

A close-up, grayscale photograph of a uPVC stable door handle and lock mechanism. The handle is a long, vertical, oval-shaped piece with a textured surface. A clear, cylindrical lock cylinder is mounted on the handle. To the right, the door's frame is visible, showing several small circular components and a rectangular slot. The background is a plain, light color.

STABLE DOORS

Our superb range of uPVC Stable Doors offer versatility, style and security.

MULTI-FUNCTIONAL

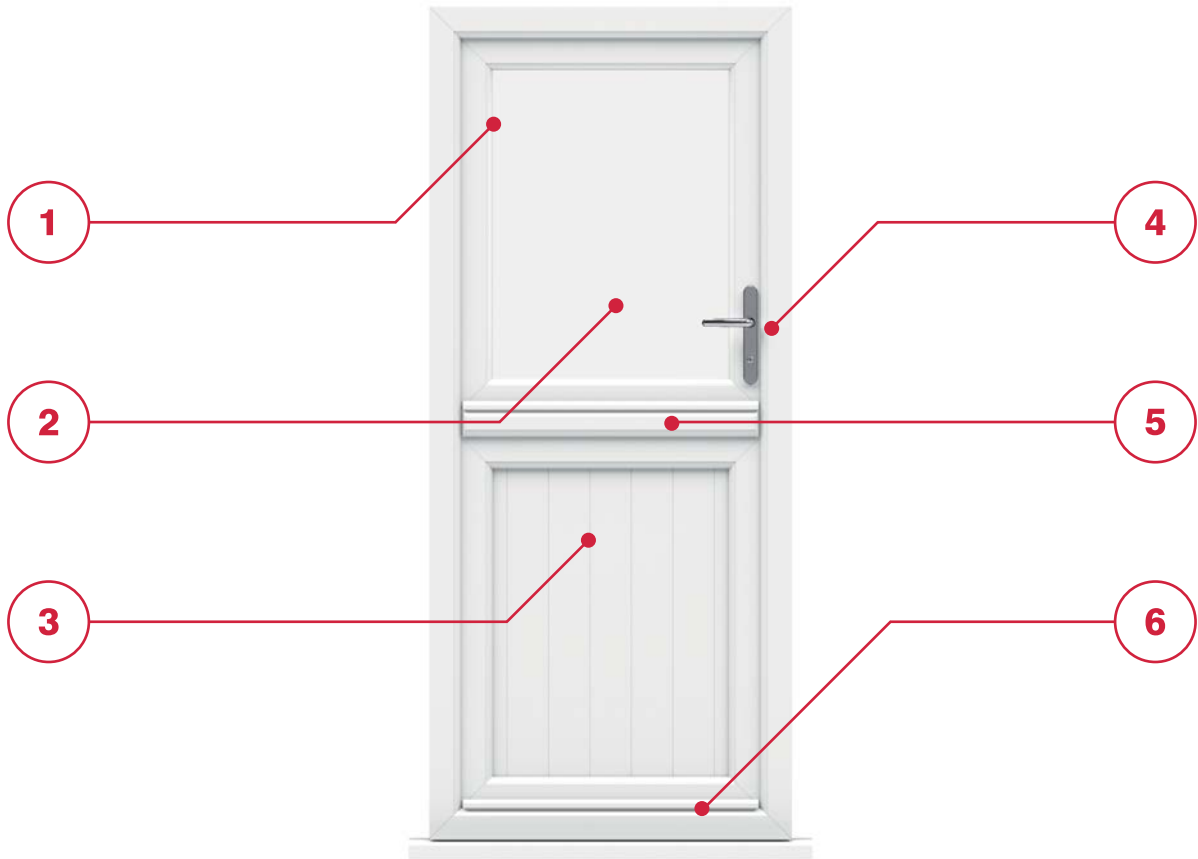

1 Useful



Upgrade to include an additional tilt facility and enjoy the ultimate in flexibility of operation.

2 Convenient



Sashes disengage to allow the top half of the door to move independently from the bottom.

3 Versatility



With the two sashes coupled together the product functions as a normal entrance door.

4 High Security



For your peace of mind high security locking systems are fitted as standard.

5 Double Drip Bars



Drip bars are fitted to both sashes of all our stable doors, as standard, to prevent water ingress.

6 Low Threshold



Low threshold and wheelchair threshold options are available on our stable doors.



FRENCH DOORS

Connect your home to your garden with our
stunning uPVC French Doors.

CONTINENTAL FLAIR



1 Security Shootbolts



Yale Lockmaster® multipoint lock with added high security shootbolts supplied as standard.

2 10 Year Guarantee



10 year manufacturer's guarantee against cracking, warping or discolouration.

3 Milled Threshold



Exclusive milled frame-to-threshold jointing system eliminates moulded plastic end caps.

4 Door Restrictors



Optional fitted restrictors avert damage by preventing opening past a set angle.

5 Hinges by SFS Intec



Available in 8 colours, our premium range of Italian 'Dynamic 2D' door hinges offer a slimline design.

6 Cohesive Colour



Great collection of RENOLIT foils available across our entire range for total consistency.



PATIO DOORS

Enhance your home with our revolutionary uPVC sliding patio doors.

STYLISH & SECURE

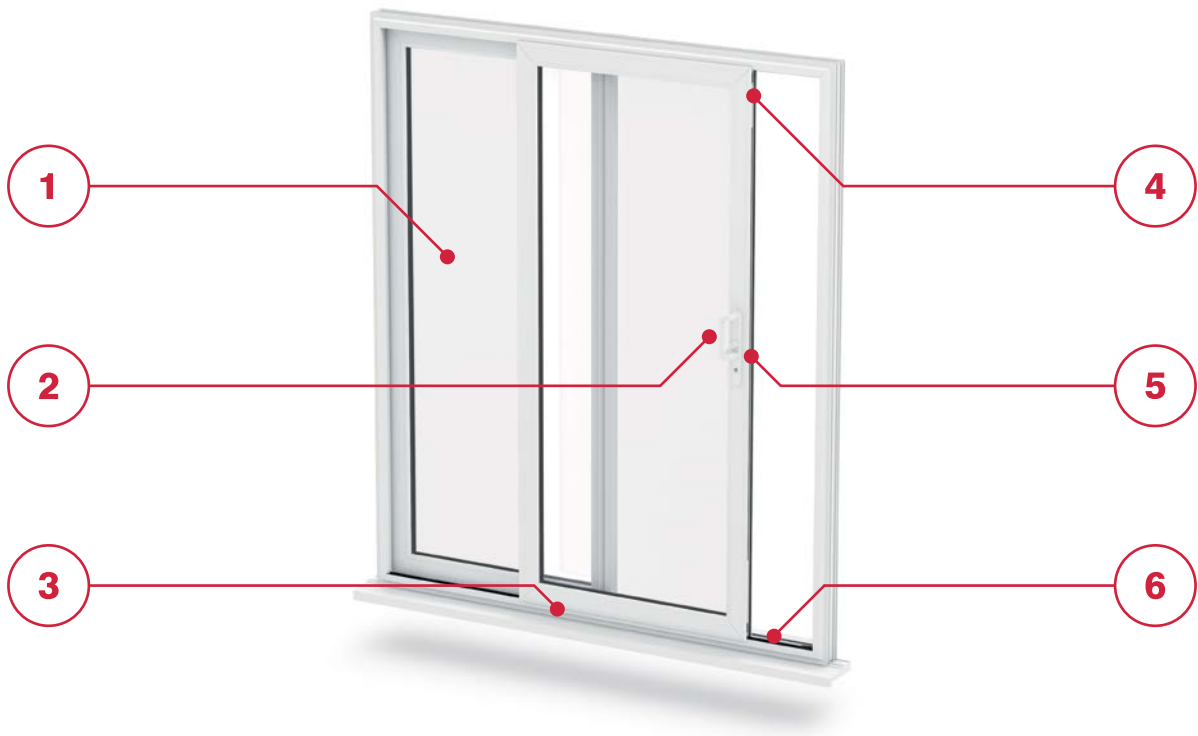

1 Liniar 10 Year Guarantee



All profiles are guaranteed against cracking, warping or discolouration for 10 years from installation.

2 Yale ModLok™



The modular locking system in our doors makes them the most secure uPVC patio in the market.

3 Air-Glide System



Multi-wheeled 'air-glide' running system keeps perfect balance for smooth and silent operation.

4 Maximum Security



High tensile steel shootbolts provide additional locking points at both head and cill.

5 Child Friendly



The locking mechanism has a 'finger-traps-free' design to protect small children.

6 Clever Thresholds



Wrap-over design prevents scuff marks. Low threshold and ramp also available.



BI-FOLD DOORS

Gain panoramic views of the outside and increased natural light inside with our beautiful bi-fold doors.

A STUNNING ADDITION

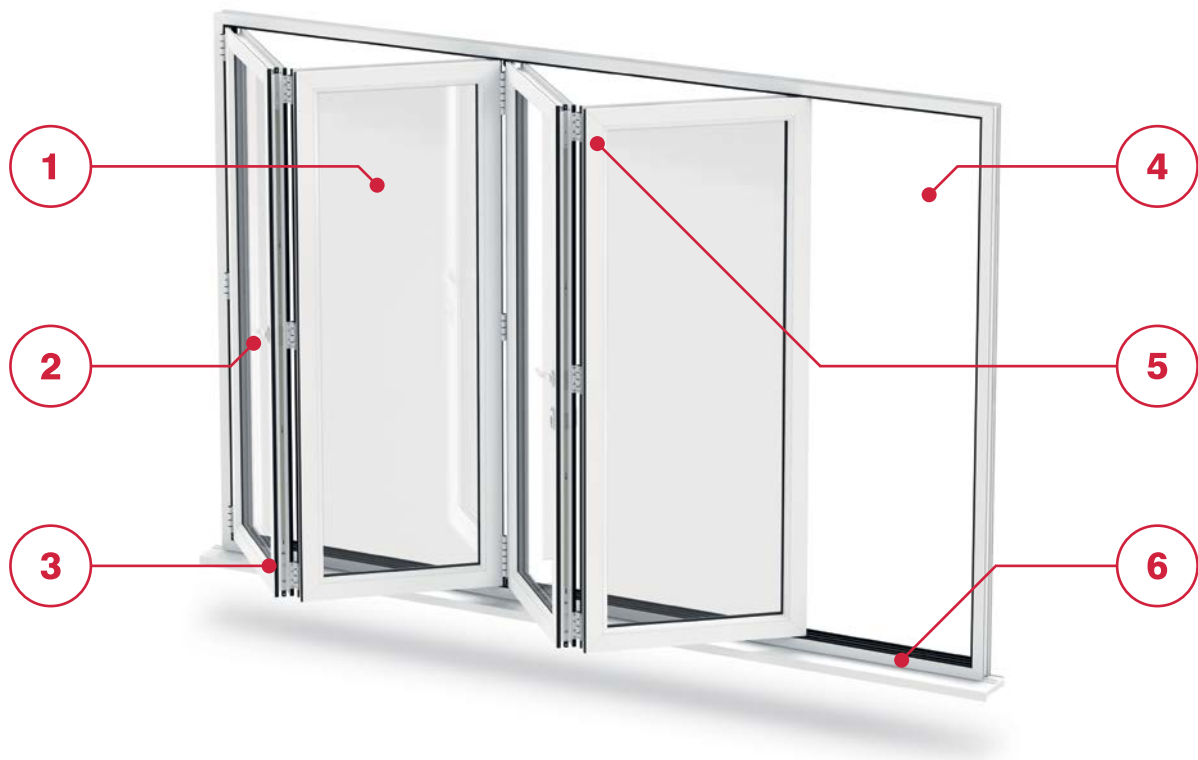

1 Flexible Configuration



With styles from 2-7 panes and various fold configurations, tailor your doors to suit your needs perfectly.

2 Unified Components



Patented Liniar hardware works harmoniously with the range of Liniar energy efficient profiles.

3 Concealed Hardware



In-board mounted stainless steel track conceals hardware, for a clean and attractive finish.

4 Open Up Your Space



Slim outer frame ensures that up to 90% of the aperture remains unobstructed when fully open.

5 Aluminium Alternative



Our uPVC bi-fold doors are robust enough to compete with more expensive aluminium products.

6 Ultra-Low Threshold



Available with an aluminium 24mm low threshold and optional wheelchair access ramp.

DOOR ACCESSORIES

Your door, tailored to your home.

Knockers



White



Black



Chrome



Gold



Silver



Cat Flaps

Spy Holes





DOOR LETTERBOXES

White



Black



Chrome



Gold



Silver



LOCKMASTER®



Britain's best selling multi-point door lock

10 Year Guarantee

The multi-point Yale Lockmaster® comes as standard on all our entrance doors, providing your home with the protection it deserves.

Available in both lever/lever and lever/pad configurations the Yale Lockmaster® comes with a 10 year manufacturer's guarantee against mechanical breakdown.

Pre-Compression Roller

Pre-compression roller cams ensure smooth operation and maximise weather-proofing.

Claw Hooks

Claw hooks grip the door sash to the frame for extra strength and solidity.

Anti-lift Pins

Anti-lift pins slot into the frame preventing the door from being moved or lifted.

Centre Latch & Hook

The central latch combines with an anti-separation hook to create a solid and rigid locking point.





THE WORLD'S FAVOURITE

By partnering with Yale, we give you total security and complete peace of mind.



CONSERVATORIES

Extend your home with a beautiful uPVC conservatory.



DESIGN OPTIONS



Victorian

The traditional design includes a three or five facet bay that projects out giving an attractive curved outline and excellent outside views. The beautiful finials that line the roof add a lavish finishing touch.



Lean-To

Popular and cost-effective, lean-to conservatories are ideal if you have limited space. They are also perfect for bungalows where there can be height restrictions.



Edwardian

Edwardian conservatories are a striking addition to your home. Their square design makes the most of available space and allows for sunlight to flood inside.



Gable-Ended

The high-angled roof maximises sunlight creating a warm and airy atmosphere inside. The gable-end often incorporates a 'rising-sun' design, a stylish and charming feature.



Bespoke

Combining the lean-to conservatory with one of the other styles to create a P-shaped structure, these conservatories can be perfect if you have an unconventional building space.



Orangery

Offering more privacy than other conservatories, an orangery is a truly luxurious way to extend your home. Grand but not flashy, an orangery will provide you with a beautiful new living space.



ROOF OPTIONS

Tailor your roof to your conservatory.

CHOICES



Glass

- A glass roof provides the ultimate in solar control.
- Glass is the best choice for noise reduction.
- Self-cleaning glass is available.



Polycarbonate

- Double thickness, chambered 35 mm.
- The economic choice.
- Available in clear, opal, bronze and bronze-opal.



CONSERVATORY PROCESS

What you need to know.

A STEP BY STEP GUIDE



1. Quotation

We will discuss conservatory options with you to find the style that best suits you and your property. We will then provide you with a free, no obligation quote.



2. Design Process

We will design and produce technical drawings so that you are able to visualise your new conservatory before a single brick has been laid or window installed.



3. Technical Survey

A technical survey is carried out by one of our professional surveyors. They will visit the site in order to take accurate measurements to be used for bespoke manufacturing.



4. Plans

We will draw up a groundwork plan and a detailed structural plan using the details gathered during the technical survey. We will use this to build your conservatory.



5. Planning Permission

Usually planning permission is not required as a conservatory is a 'permitted development'. (We can carry out the planning permission process on your behalf if required.)



6. Building Work

We will lay the foundations for your new conservatory. Once these are in place we will build the base and walls that form a solid support for the uPVC structure.



7. Roof Structure

Once the walls and windows are in place we will install your choice of roof. This is the final stage of the conservatory building process.



8. Your New Conservatory

Your new conservatory is ready for you to enjoy. It's time to move your furniture in and sit back and relax in your brand new living space.



9. Guarantee

All of our conservatories are covered by a comprehensive guarantee. Why not start planning your conservatory today?

GUARANTEED PEACE OF MIND

With the perfect supply chain...



As part of an approved network of Installers, you can have complete confidence in the supply and installation of your products.

All parties in the Double Glazing Network are industry leading suppliers and independently guarantee their part of the process; therefore your guarantees are 'cast-iron'.

TruFrame

Hand Finished Windows & Doors

Our manufacturing partner, TruFrame, have an unrivalled level of excellence in manufacturing hand-finished uPVC frames, spanning over 20 years. Since partnering with Liniar, they have grown into one of the largest manufacturers of uPVC in the UK.

They in turn, guarantee all aspects of the manufacturing process, only supplying those companies who conform and comply to the ethos of the Double Glazing Network. Our own company has an excellent local reputation for the quality and real value for money we extend to all our customers old and new.

Therefore you can have complete confidence in placing your trust with Liniar, TruFrame and ourselves, undoubtedly the perfect supply chain.



PURE

UPVC Windows & Doors



Tel: 023 8069 6300

Email: sales@purewindows.co.uk

Website: www.purewindows.co.uk