

TITLE

Alitherm 300 - Wall Chart



Smart Systems Limited
Arnolds Way, Yatton,
North Somerset,
BS49 4QN
Tel: +44 (0)1934 876 100
Fax: +44 (0)1934 835 169
www.smartsystems.co.uk

CHECKED				
PRODUCT CODE				
MATERIAL	ISSUE	MOD No.	DESCRIPTION	DATE
	DRAWN	S.C.		DRAWING No.
	DATE	OCTOBER 2010		
	SCALE	N.T.S.@A3		

No unauthorised use, copy or disclosure of this drawing is to be made.
It is to be returned whenever required.

ISSUE	MOD No.	DATE

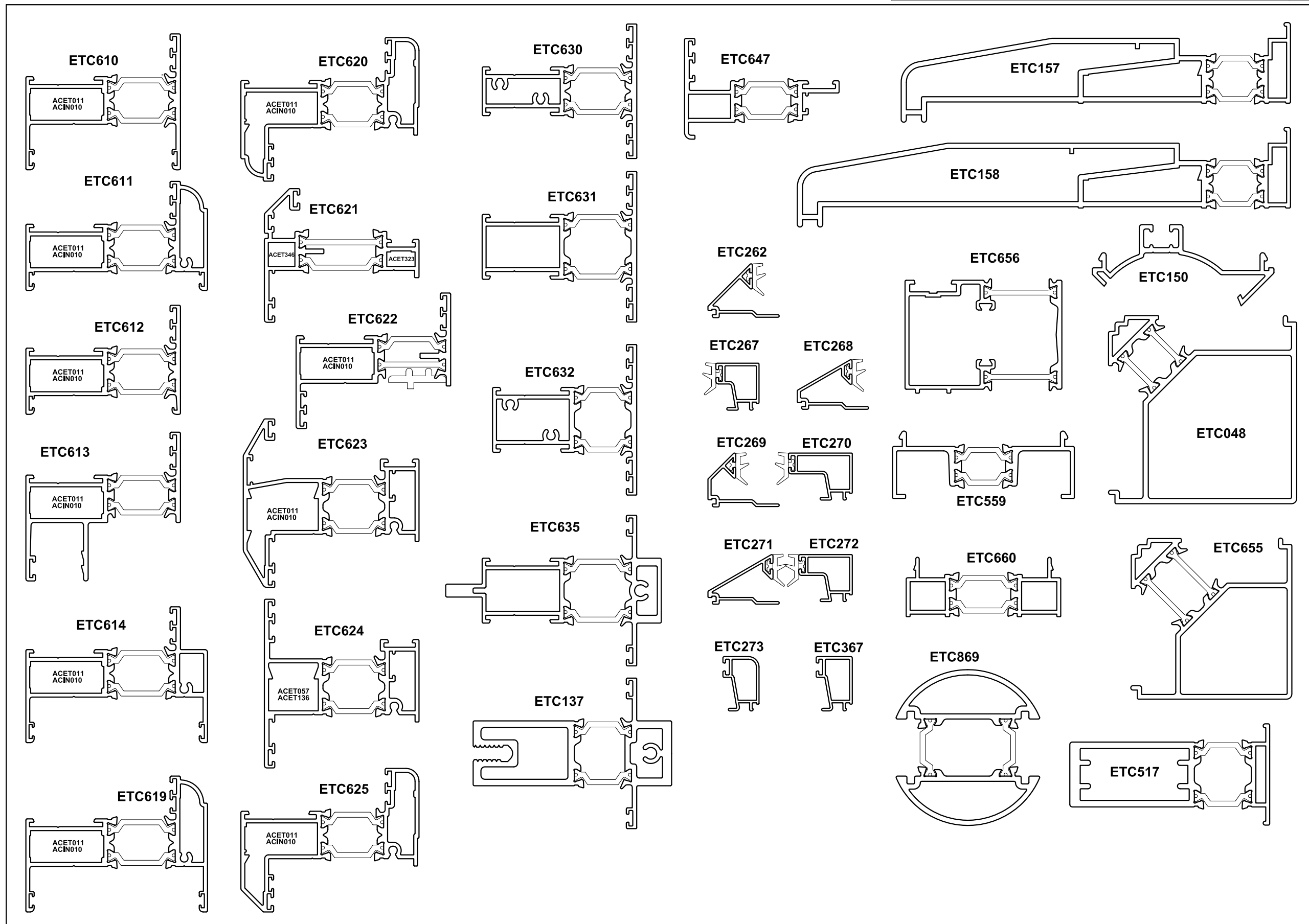

TITLE

Alitherm 600 - Wall Chart



Smart Systems Limited
Arnolds Way, Yatton,
North Somerset,
BS49 4QN
Tel: +44 (0)1934 876 100
Fax: +44 (0)1934 835 169
www.smartsystems.co.uk

CHECKED				
PRODUCT CODE				
MATERIAL	ISSUE	MOD No.	DESCRIPTION	DATE
	DRAWN	DN		DRAWING No.
	DATE	OCTOBER 2010		
	SCALE	N.T.S.@A3		

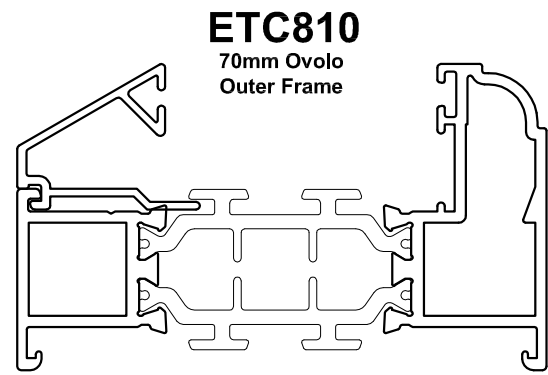

ETC810
70mm Ovolo
Outer Frame

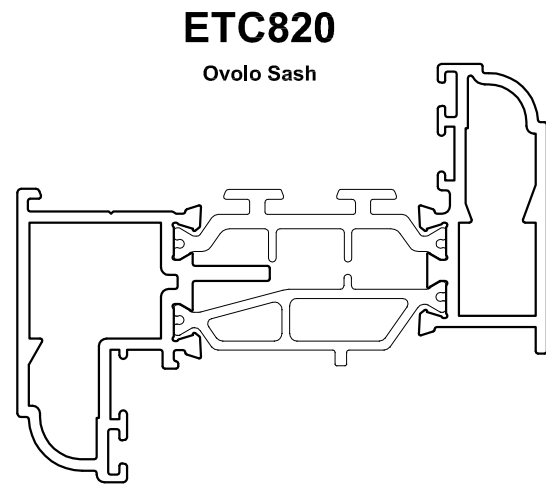

ETC820
Ovolo Sash

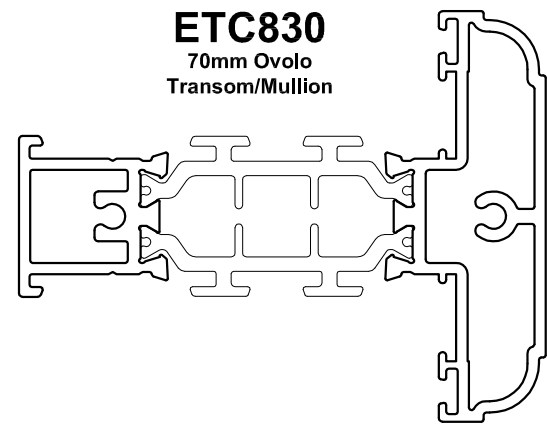

ETC830
70mm Ovolo
Transom/Mullion

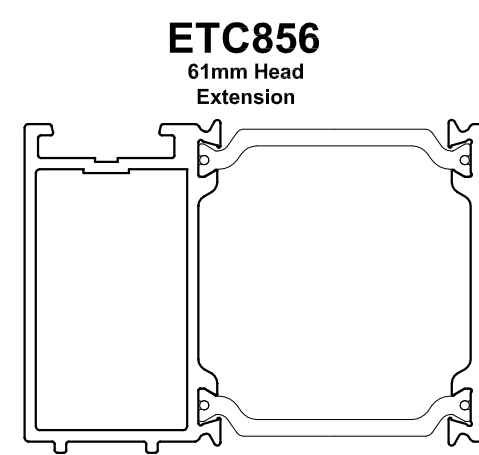

ETC856
61mm Head
Extension

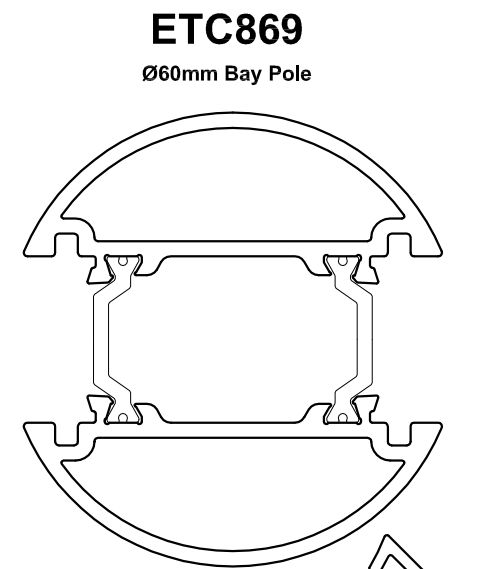

ETC869
Ø60mm Bay Pole

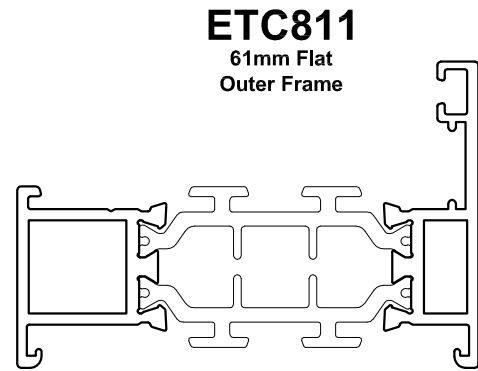

ETC811
61mm Flat
Outer Frame

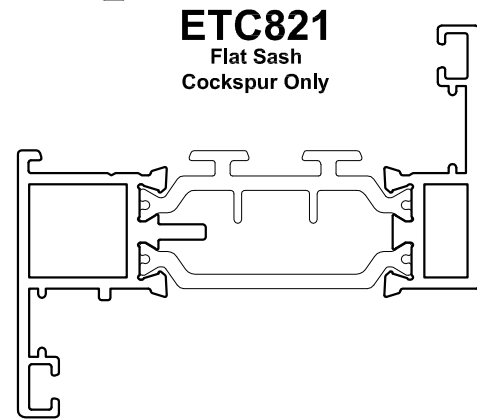

ETC821
Flat Sash
Cockspur Only

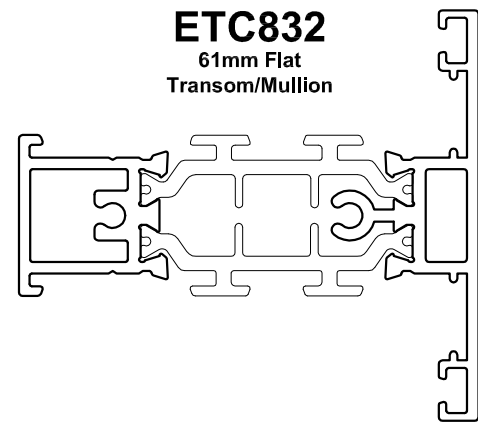

ETC832
61mm Flat
Transom/Mullion

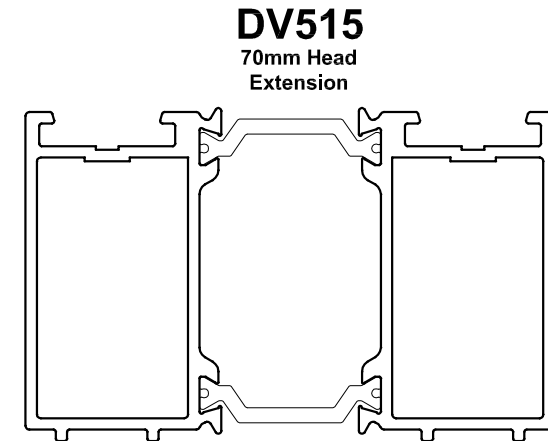

DV515
70mm Head
Extension



ETC870
Internal Bay Pole
Adaptor

ETC871
External Bay Pole
Adaptor

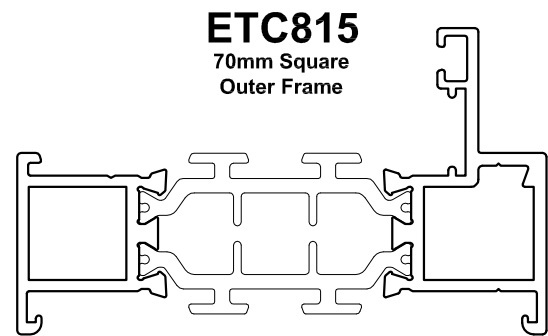

ETC815
70mm Square
Outer Frame

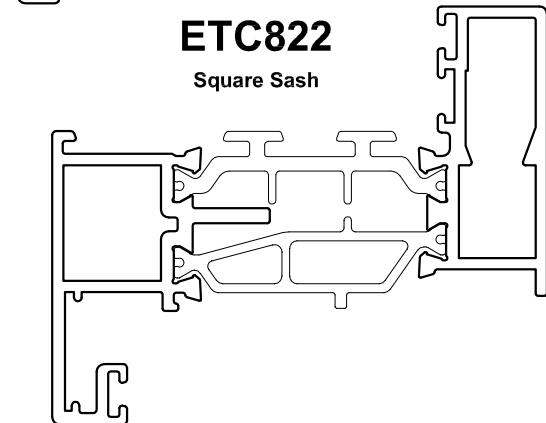

ETC822
Square Sash

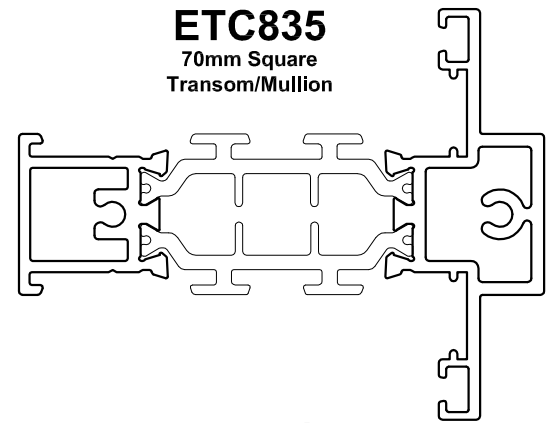

ETC835
70mm Square
Transom/Mullion

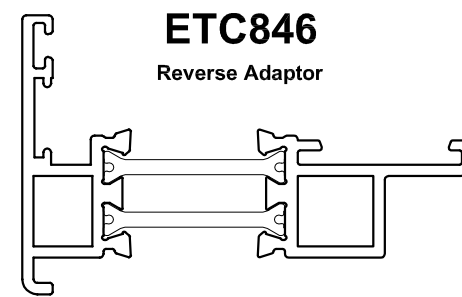

ETC846
Reverse Adaptor

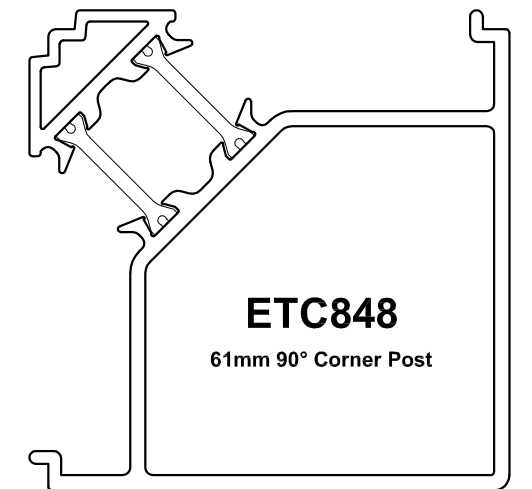

ETC848
61mm 90° Corner Post

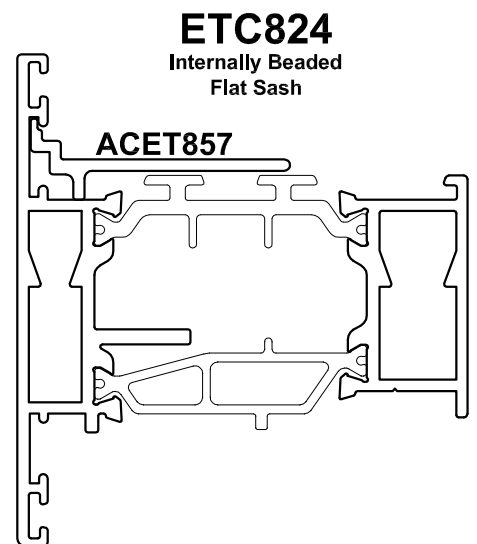

ETC824
Internally Beaded
Flat Sash

ACET857

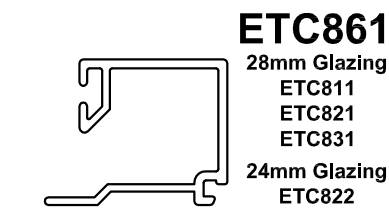

ETC861

28mm Glazing
ETC811
ETC821
ETC831

24mm Glazing
ETC822

ETC862

24mm Glazing
ETC810
ETC830



ETC863

24mm Glazing
ETC820



ETC864

24mm Glazing
ETC811
ETC821
ETC831



ETC867

28mm Glazing
ETC811
ETC821
ETC831



ETC868

28mm Glazing
ETC820

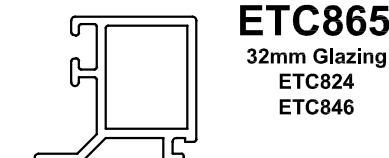

ETC865

32mm Glazing
ETC824
ETC846



ETC866

28mm Glazing
ETC824
ETC846

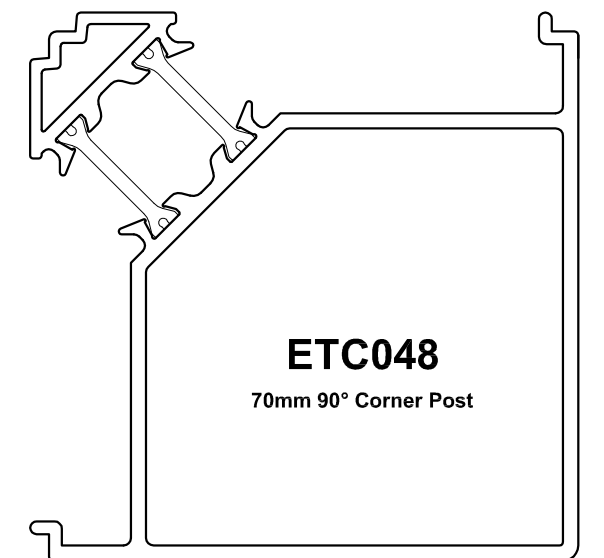

ETC048
70mm 90° Corner Post

No unauthorised use, copy or disclosure of this drawing is to be made.
It is to be returned whenever required.

ISSUE	MOD No.	DATE

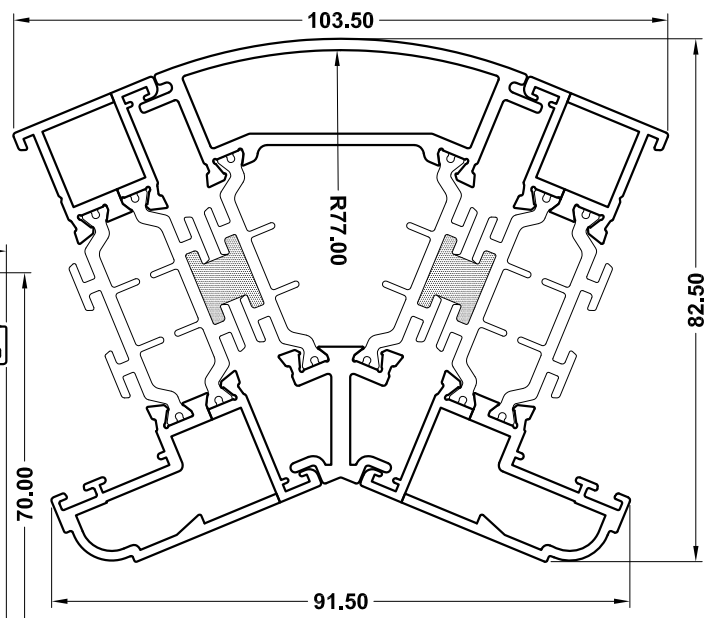
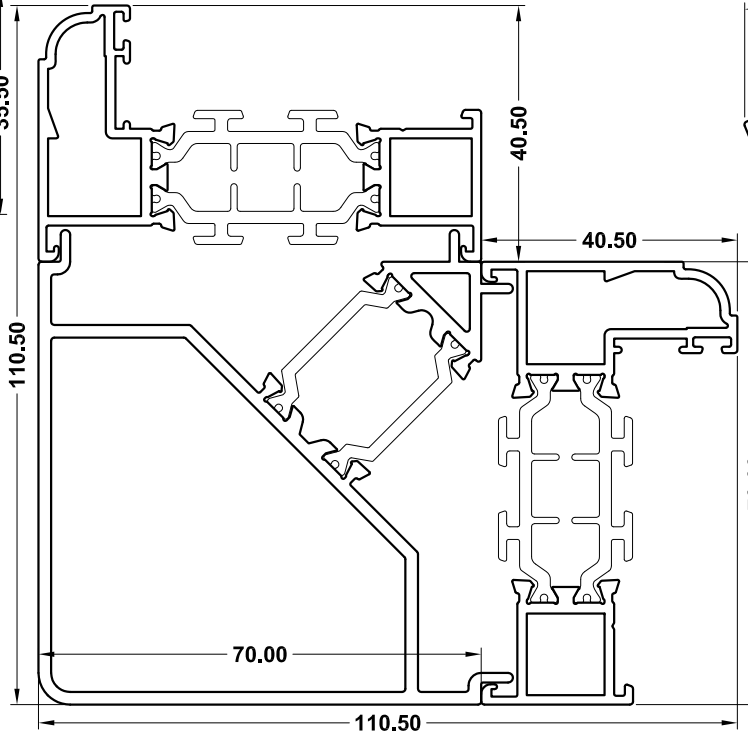
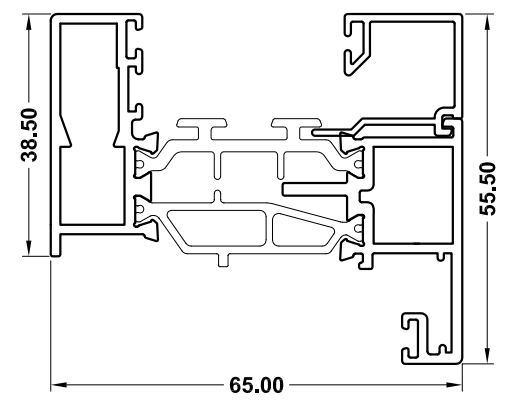
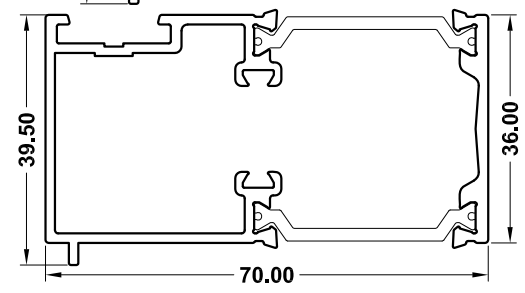
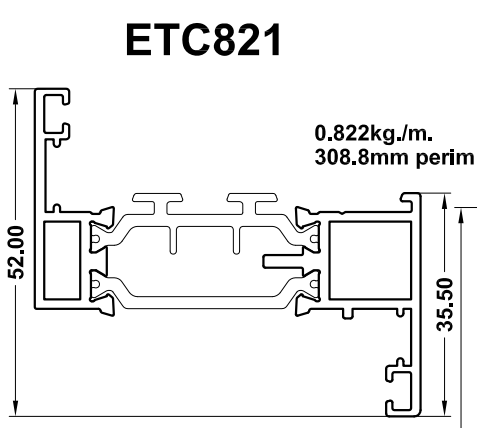
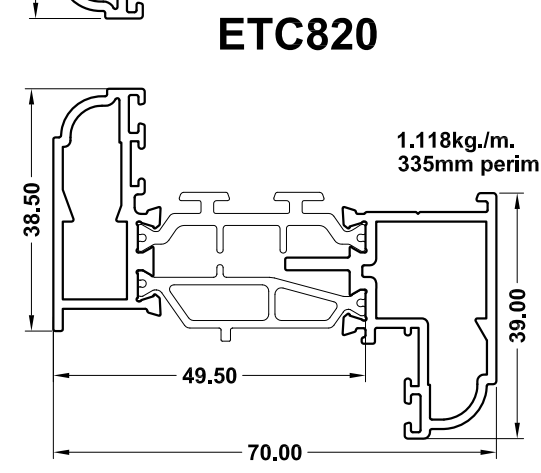
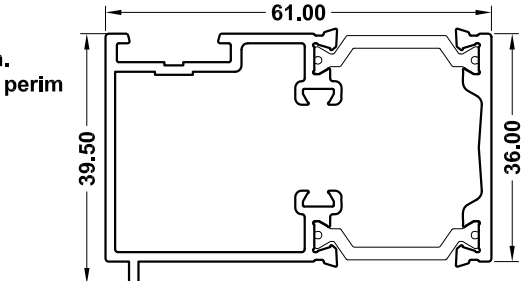
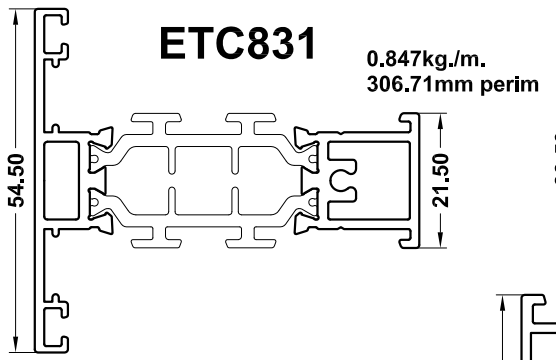
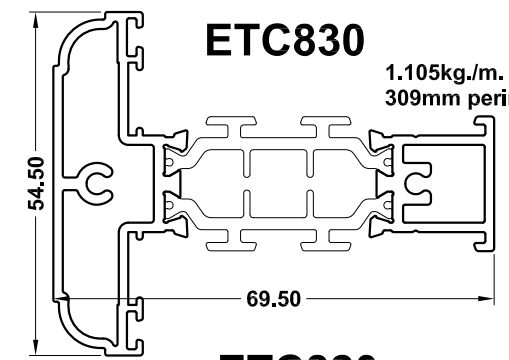
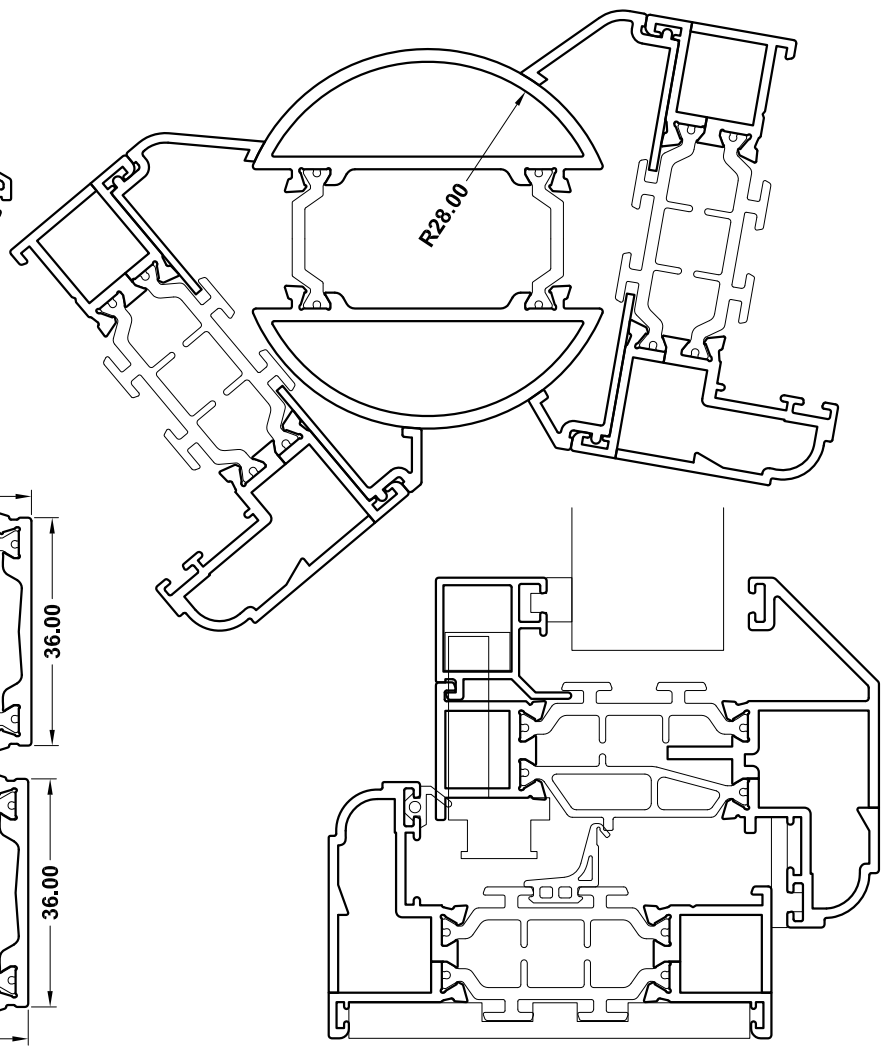
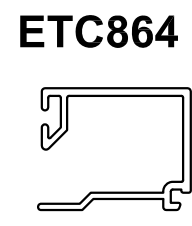
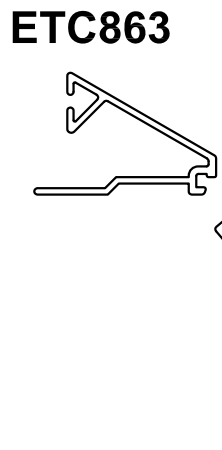
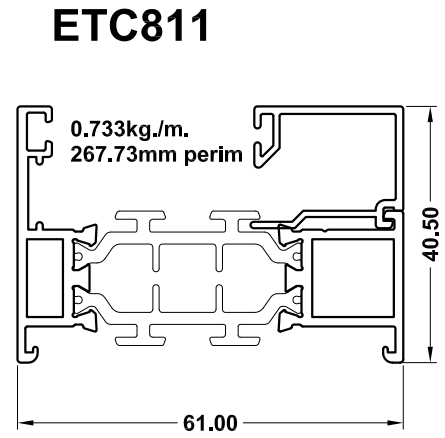
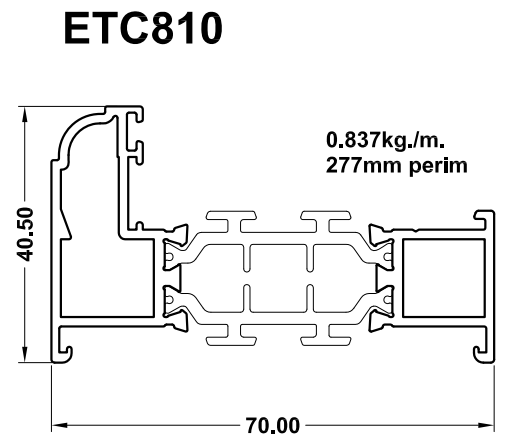

TITLE

Alitherm 800- Wall Chart



Smart Systems Limited
Arnolds Way, Yatton,
North Somerset,
BS49 4QN
Tel: +44 (0)1934 876 100
Fax: +44 (0)1934 835 169
www.smartsystems.co.uk

CHECKED				
PRODUCT CODE				
MATERIAL				
	ISSUE	MOD No.	DESCRIPTION	DATE
	DRAWN	D.N.		DRAWING No.
	DATE	JULY_2010		
	SCALE	N.T.S.@A3		

No unauthorised use, copy or disclosure of this drawing is to be made.
It is to be returned whenever required.

ISSUE	MOD No.	DATE

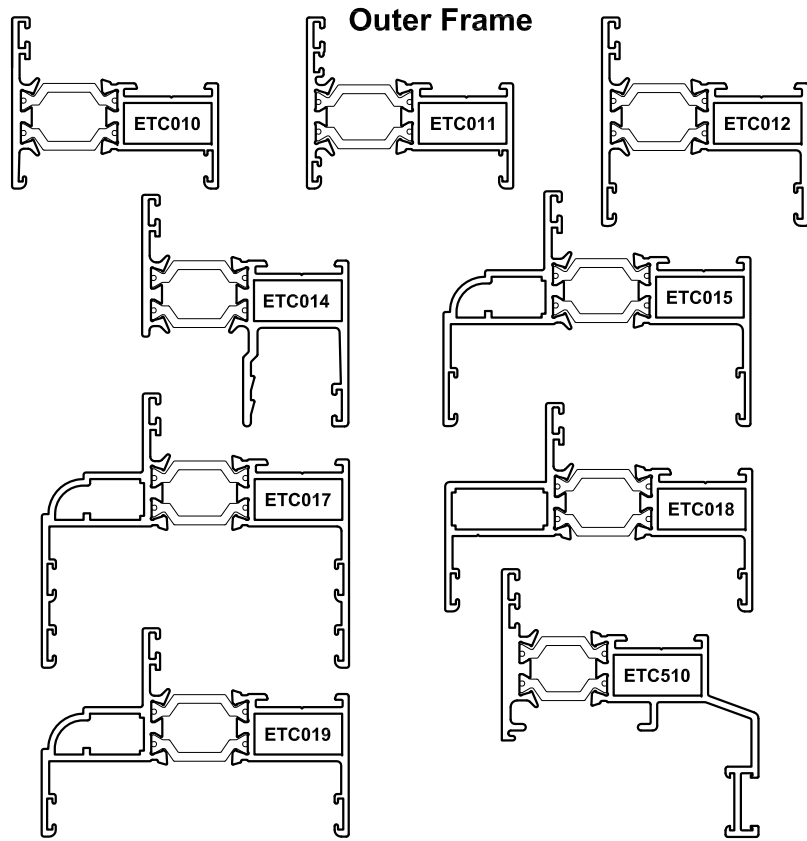

Outer Frame

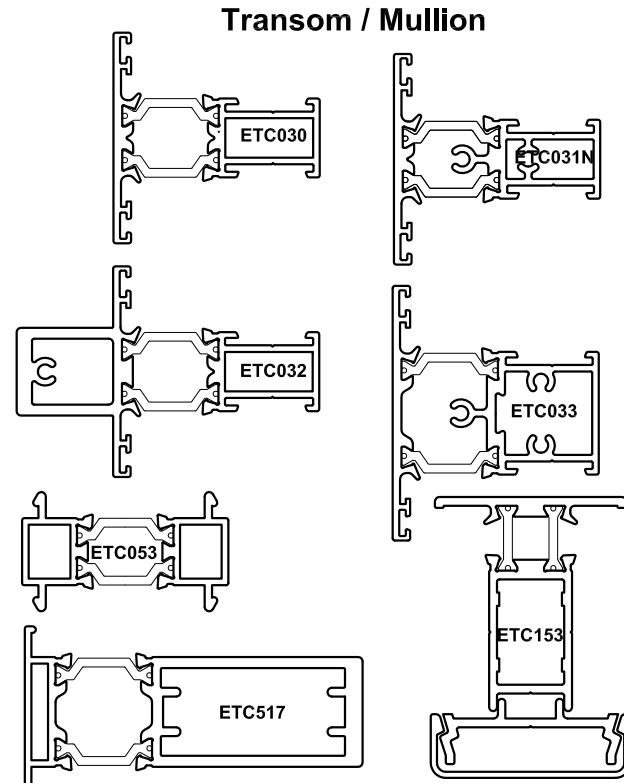

Transom / Mullion

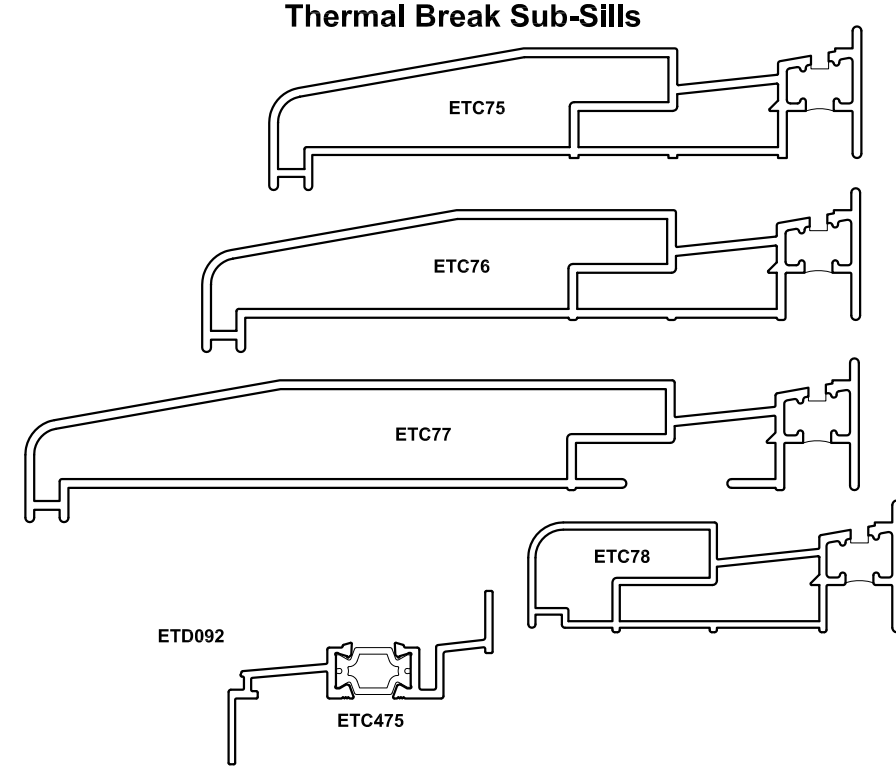

Thermal Break Sub-Sills

Variable Angle Mullion

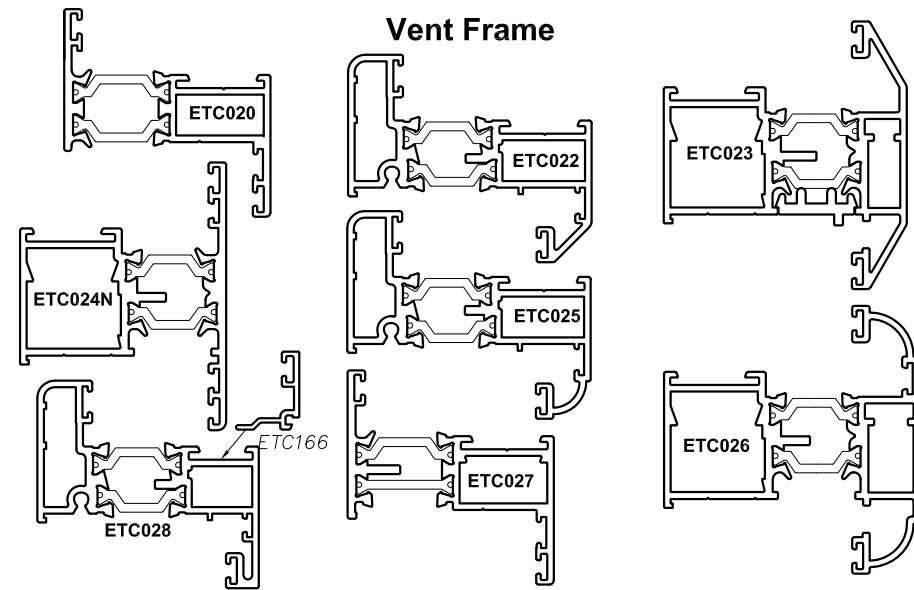
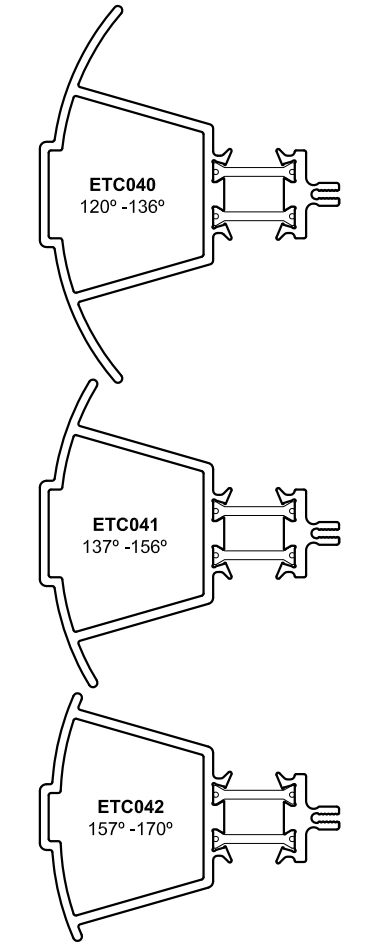

Vent Frame

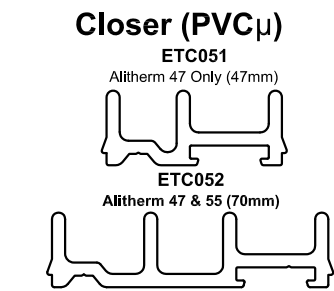

Closer (PVCµ)

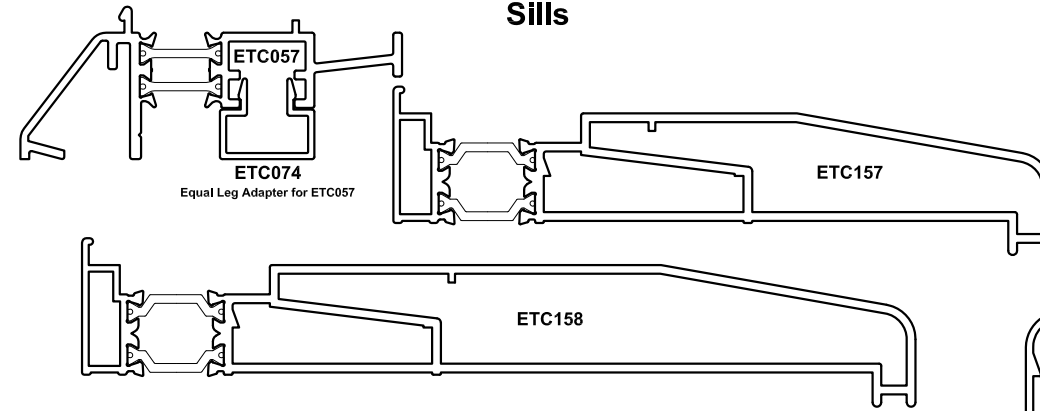

Sills

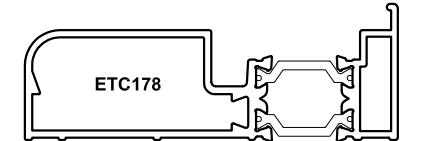

ETC178

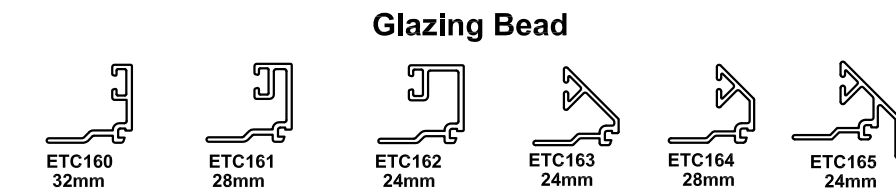

Glazing Bead

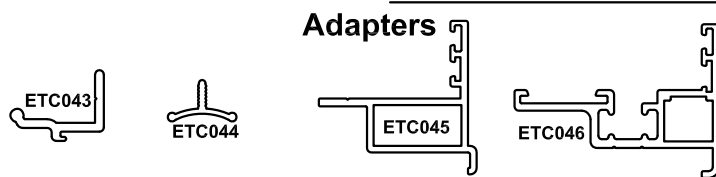

Adapters

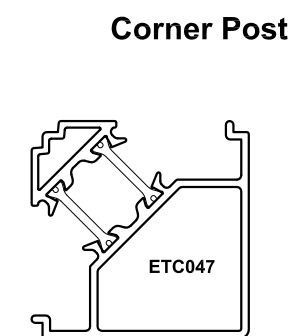

Corner Post

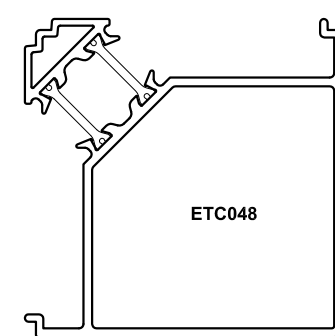

ETC048

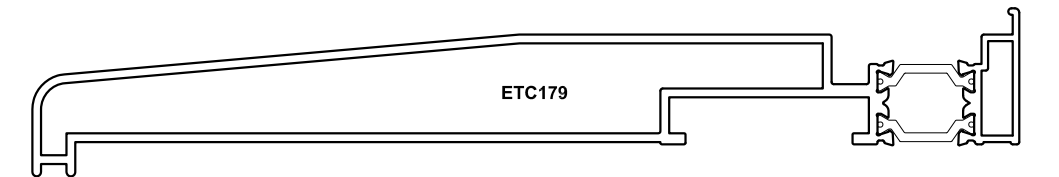

ETC179

Thermal Break Bay Pole

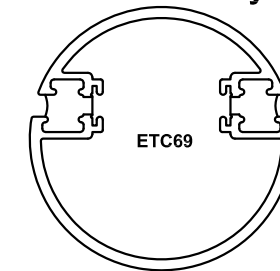

ETC69

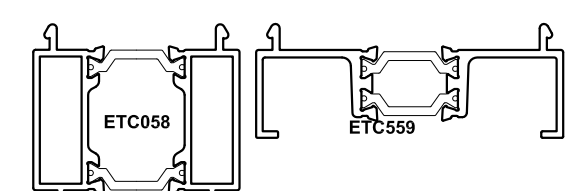

Head Extension

ETC058

ETC559

ETC16
Not in the Price Book

Issue Date: February 2007

TITLE

Alitherm 47 (Window) - Wall Chart



Smart Systems Limited
Arnolds Way, Yatton,
North Somerset,
BS49 4QN
Tel: +44 (0)1934 876 100
Fax: +44 (0)1934 835 169
www.smartsystems.co.uk

CHECKED			
PRODUCT CODE			
MATERIAL			
	ISSUE	MOD No.	DESCRIPTION
	DATE	JULY_2010	
	SCALE	N.T.S.@A3	
			DATE
			DRAWING No.

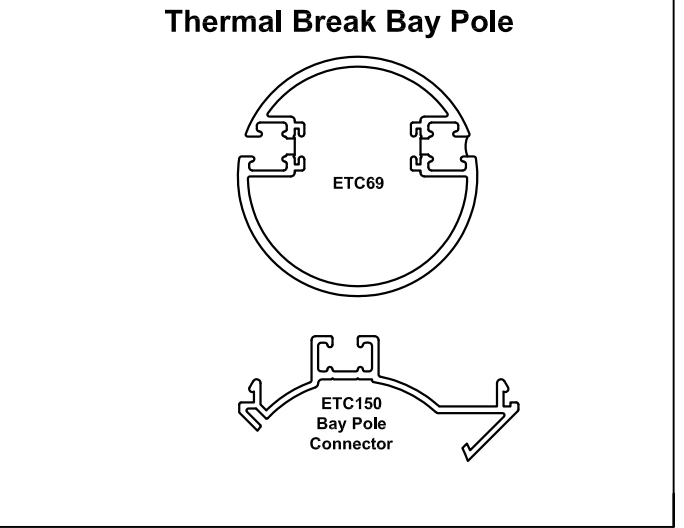
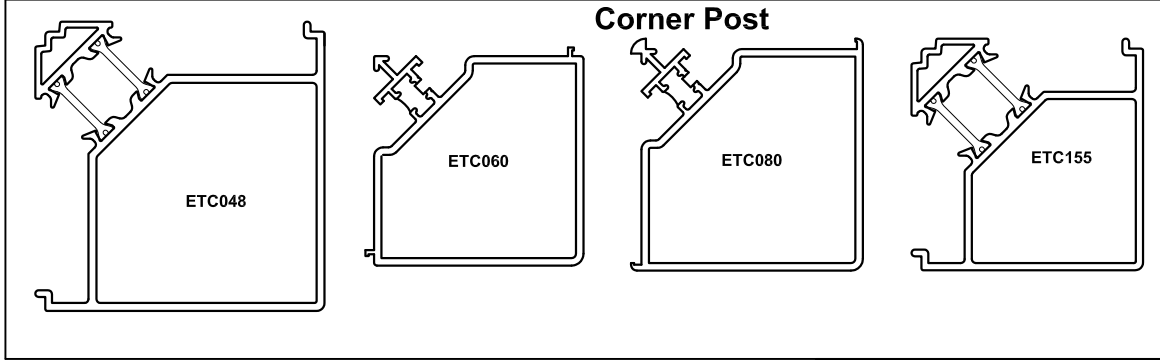
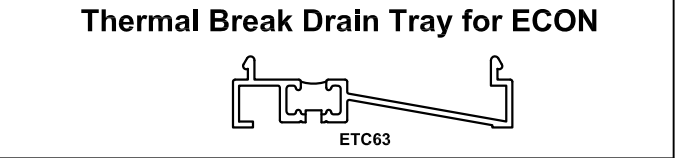
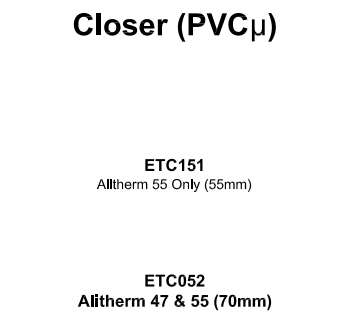
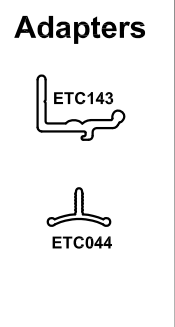
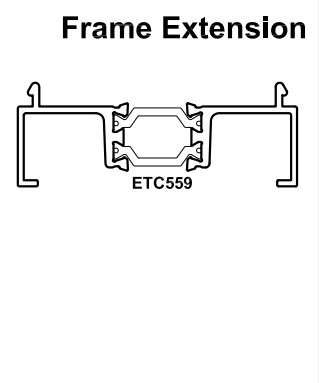
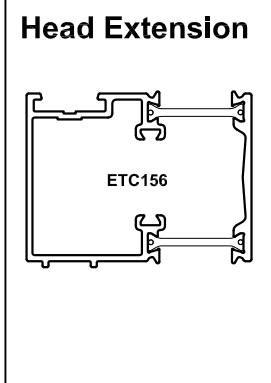
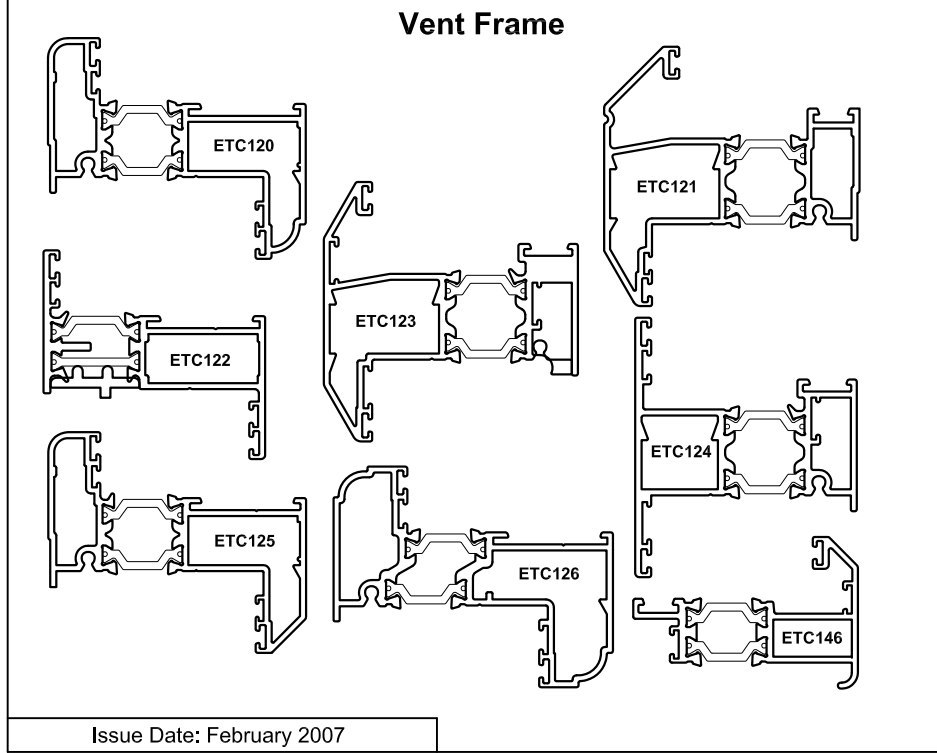
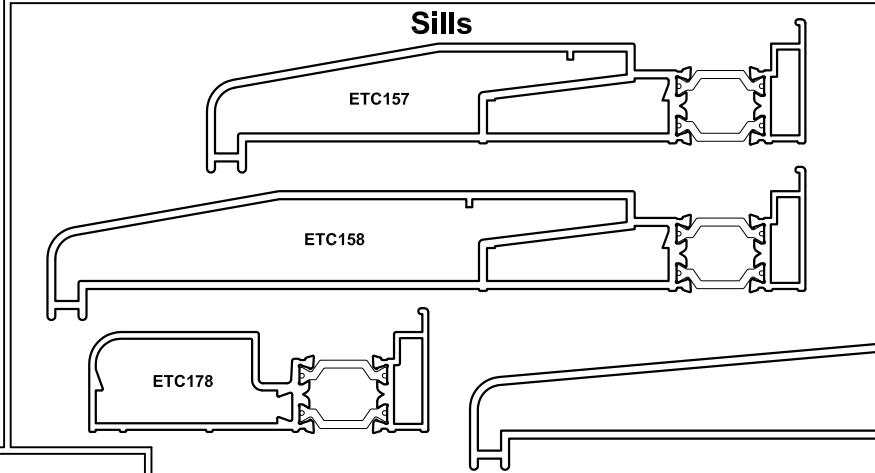
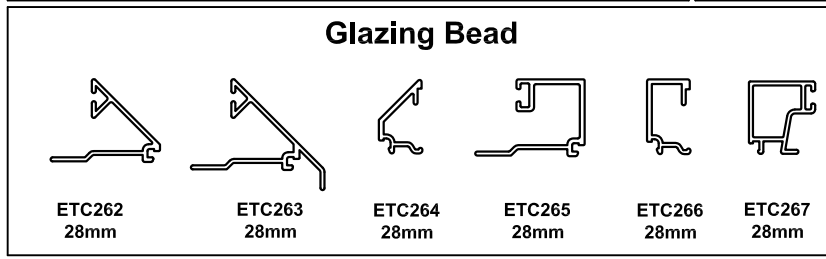
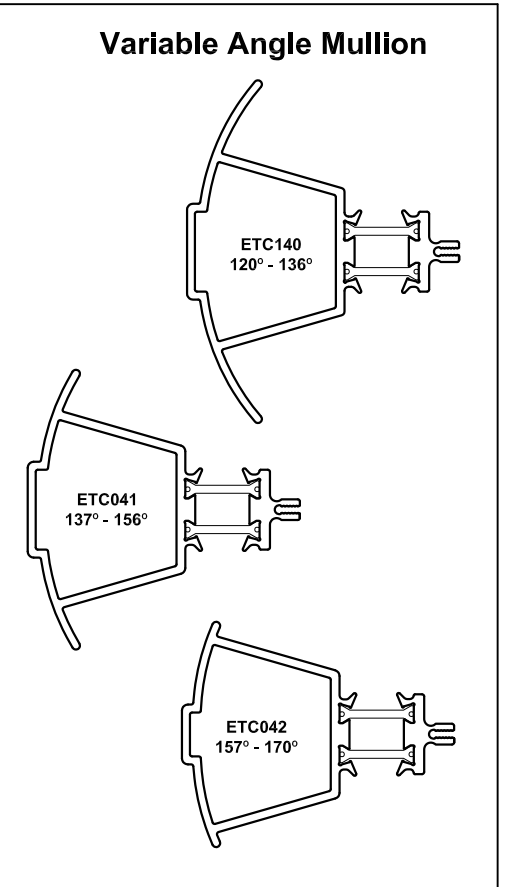
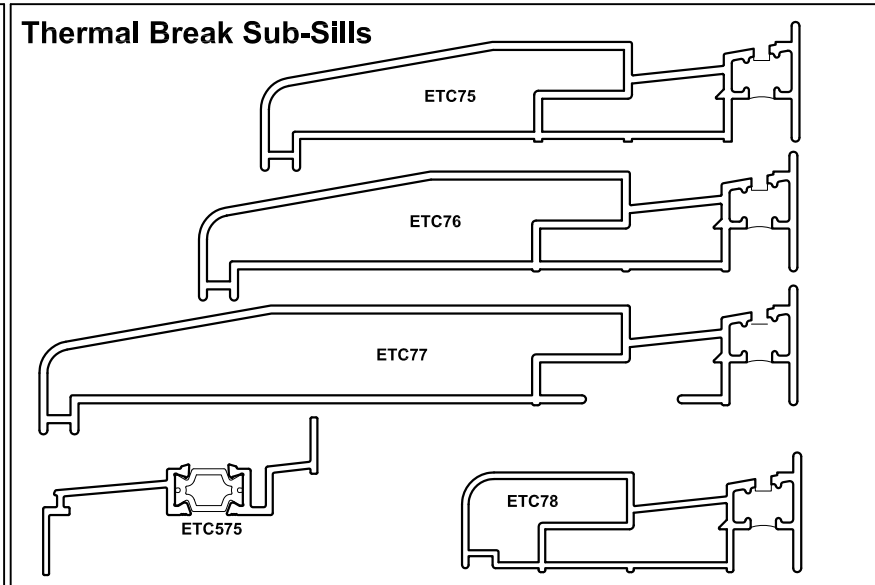
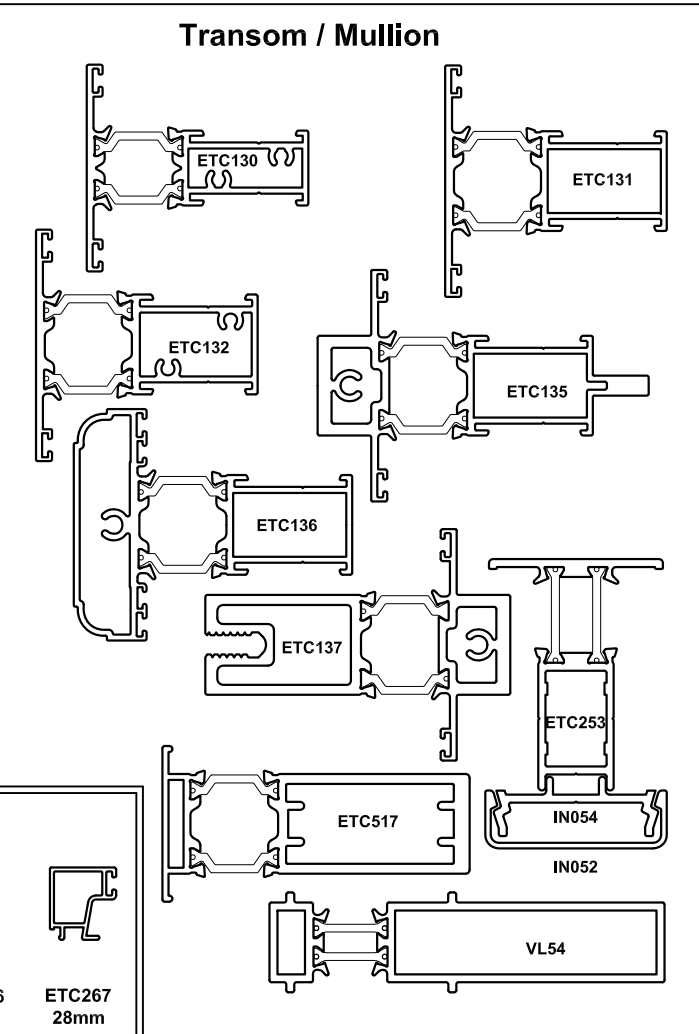
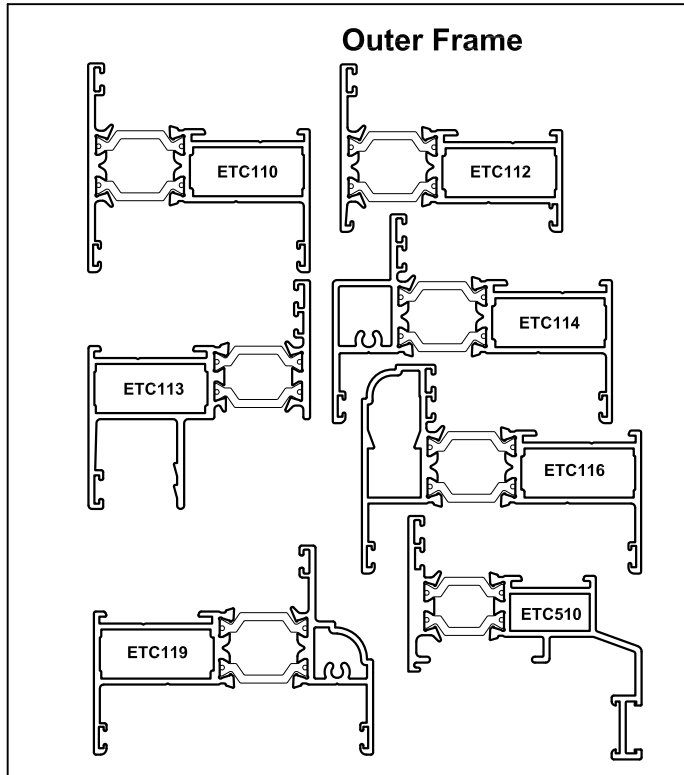



Issue Date: February 2007

TITLE **Alitherm 55 (Window) - Wall Chart**

smart
architectural aluminium

Smart Systems Limited
Arnolds Way, Yatton,
North Somerset,
BS49 4QN
Tel: +44 (0)1934 876 100
Fax: +44 (0)1934 835 169
www.smartsystems.co.uk

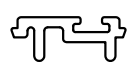
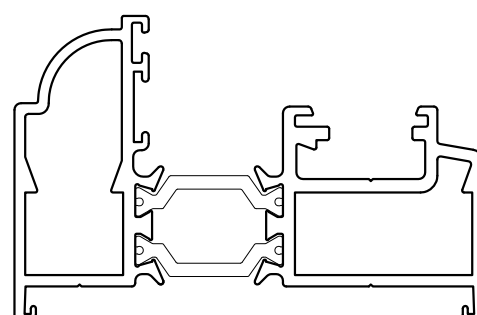
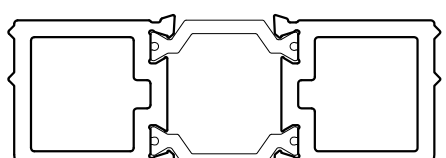
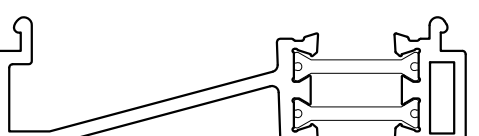
CHECKED			
PRODUCT CODE			
MATERIAL	ISSUE	MOD No.	DESCRIPTION
	DRAWN	D.N.	DRAWING No.
	DATE	JULY_2010	
	SCALE	N.T.S.@A3	

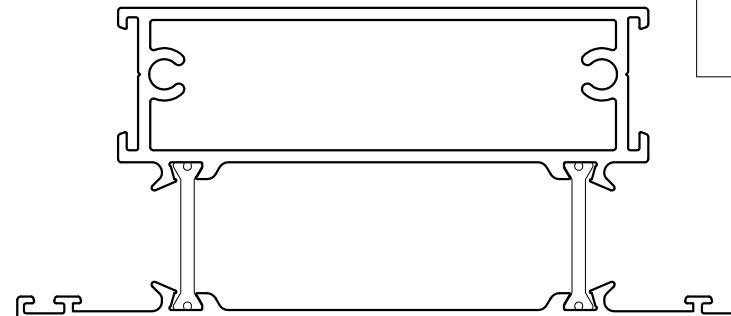
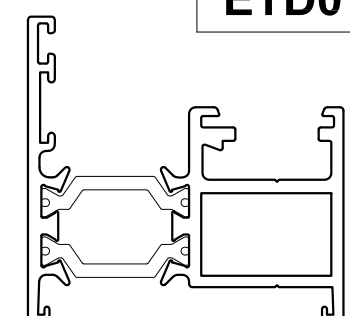
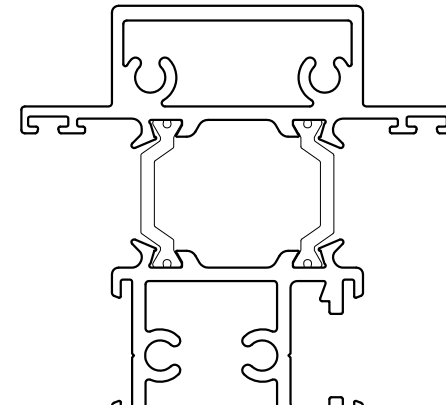
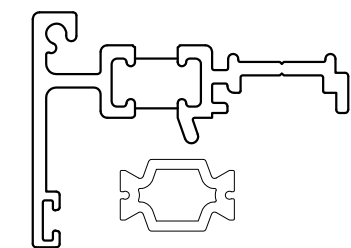
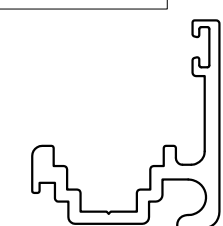
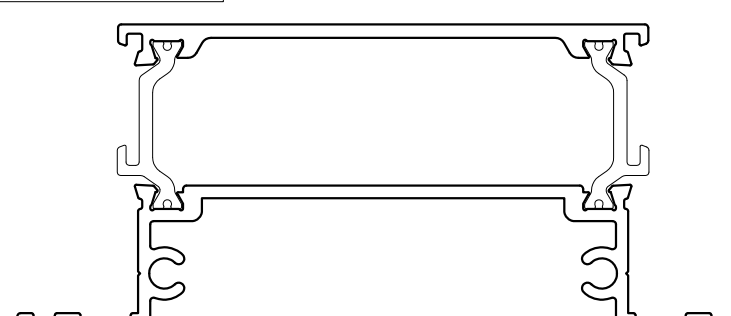
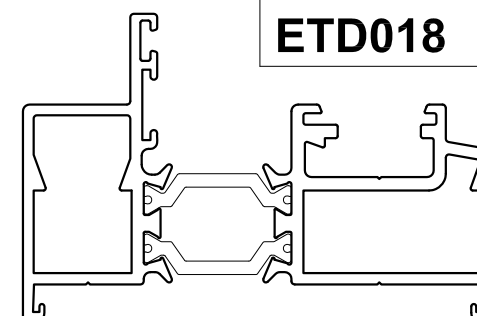
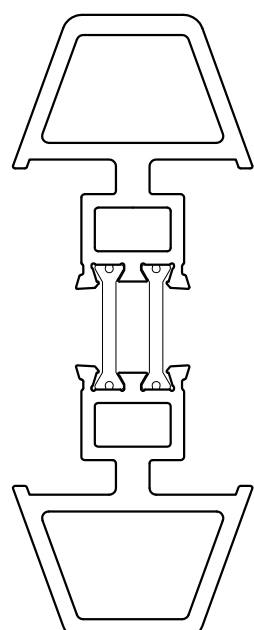
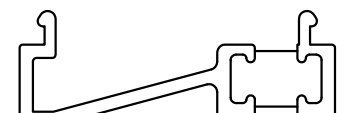
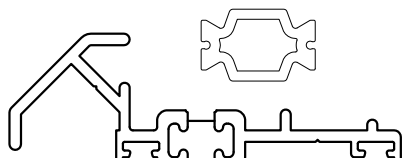
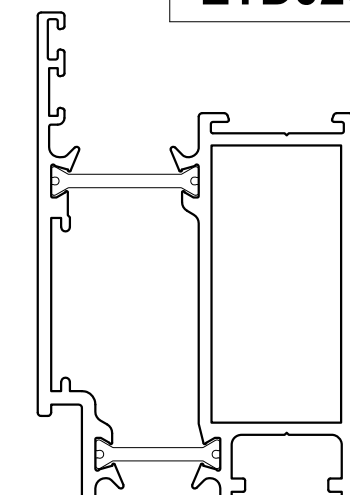
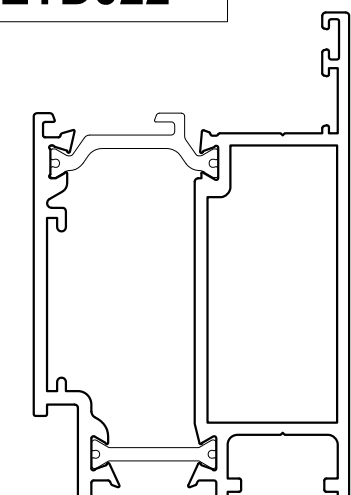
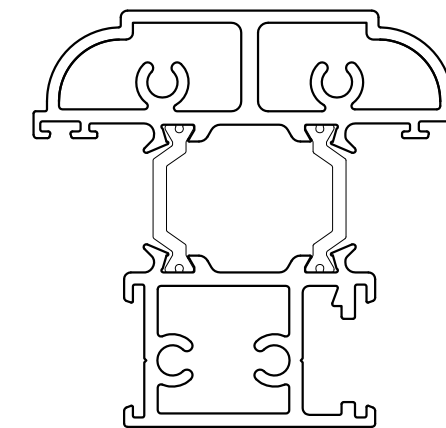
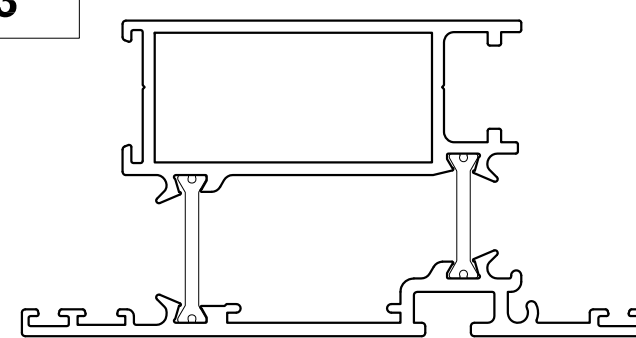
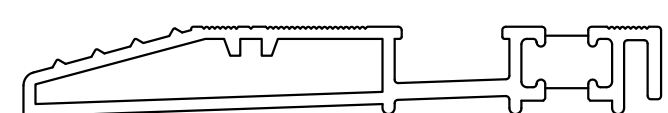
PCX16 		ETD014 		ETD053 		ETD095 		ETD094  SWL1419	
ETD030 		ETD010 		ETD032 		ETD046  SWL1360		ETD045  SWL1361B	
ETD033 		ETD018 		ETD051 		ETD092 		ETD093 	
ETD020 	ETD022 	ETD031 		ETD023 		ETD090 			

TITLE

Alitherm Door - Wall Chart

smart
architectural aluminium

Smart Systems Limited
Arnolds Way, Yatton,
North Somerset,
BS49 4QN
Tel: +44 (0)1934 876 100
Fax: +44 (0)1934 835 169
www.smartsystems.co.uk

CHECKED				
PRODUCT CODE				
MATERIAL	DRAWN	DRAWN	DATE	DRAWING No.
	DATE	JULY_2010		
	SCALE	N.T.S.@A3		

No unauthorised use, copy or disclosure of this drawing is to be made.
It is to be returned whenever required.

ISSUE	MOD No.	DATE

Outer Frame

Transom / Mullion

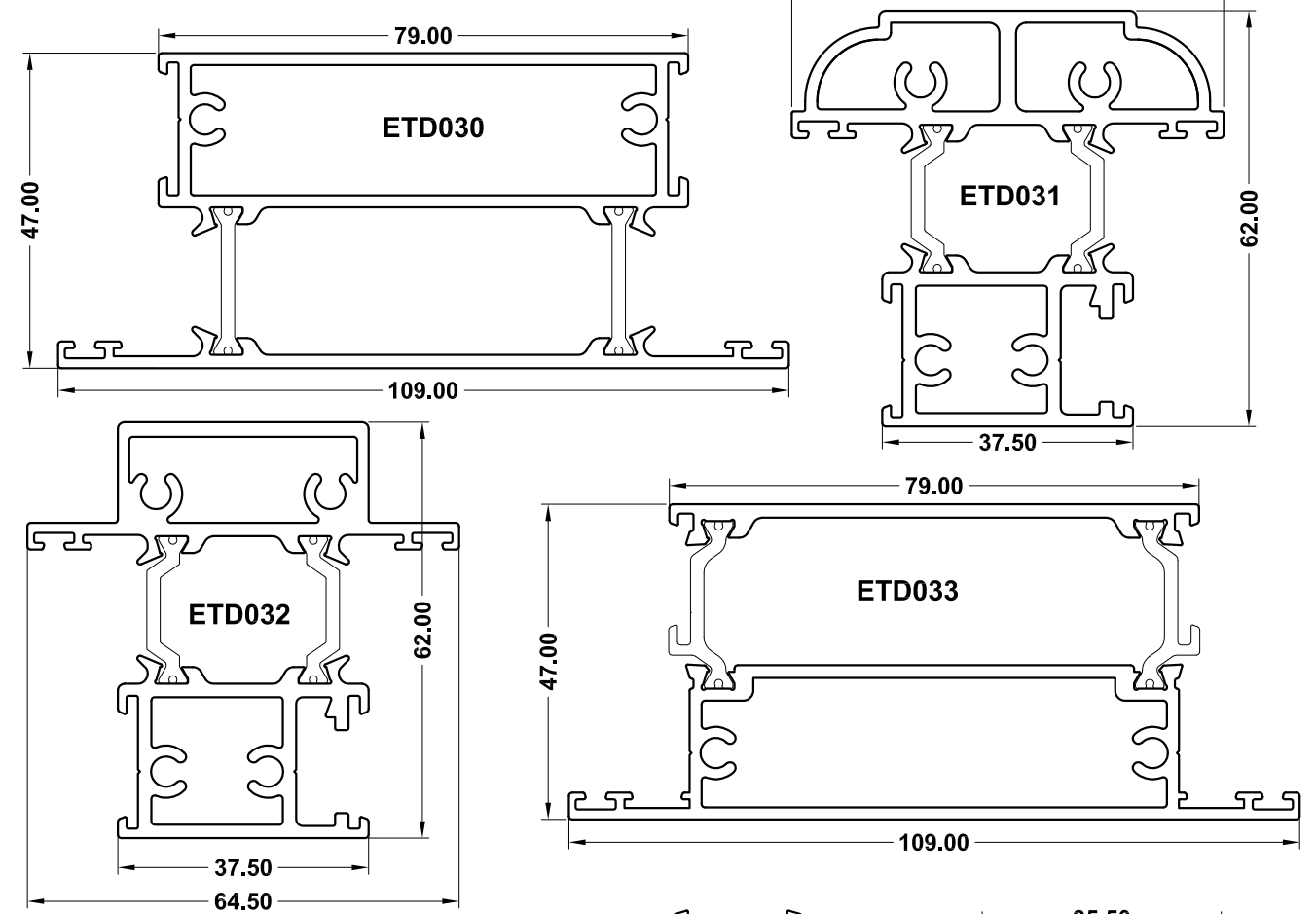
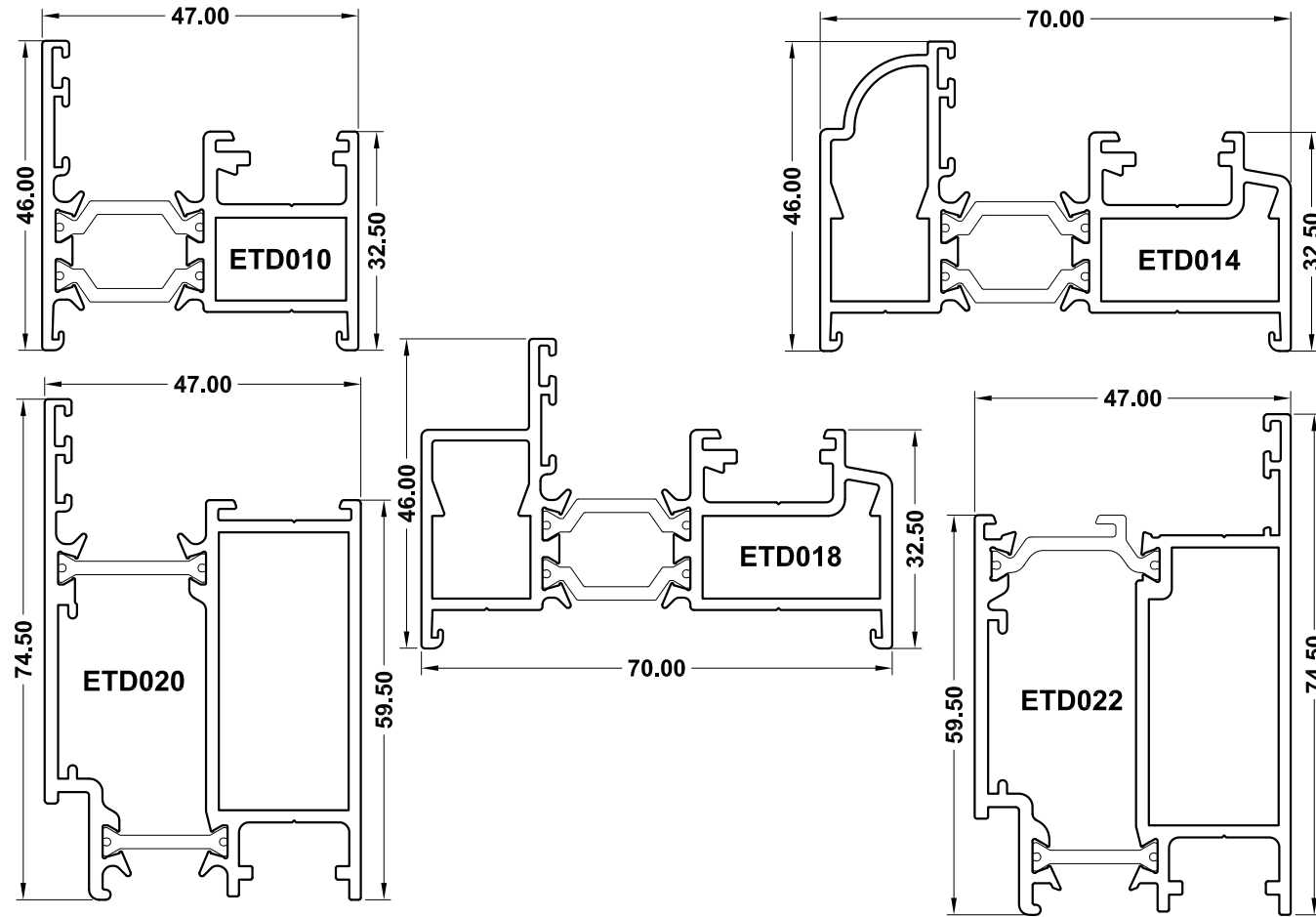

Low Threshold for 70mm Outer Frame

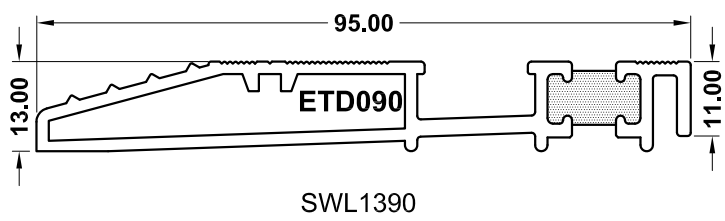

Thermal Break Drainage sub-Sill - 47mm

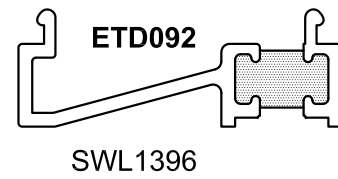

Infill Plate

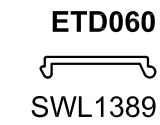

Rebate Adapters

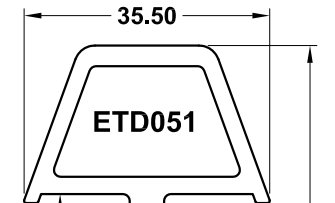
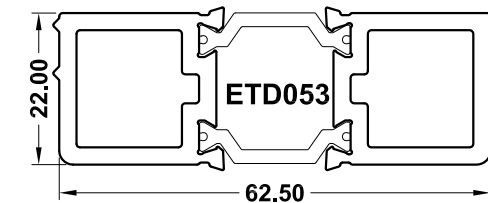
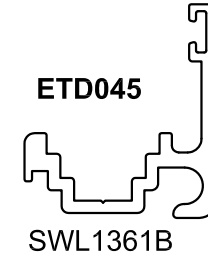

Meeting Stile Adapter

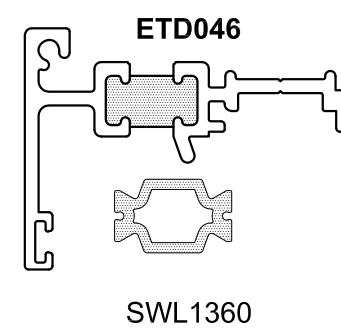

Low Threshold with Pile Car

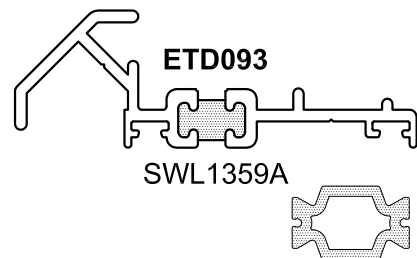

Low Threshold with Pile Car

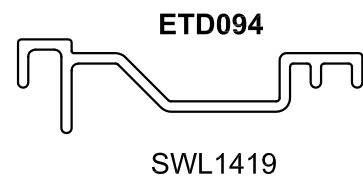

Low Threshold with Pile Car

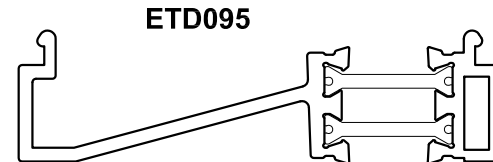

Outer Frame Close With Strip Channel



Issue Date: March 2007

TITLE

Alitherm 55 (Door) - Wall Chart



Smart Systems Limited
Arnolds Way, Yatton,
North Somerset,
BS49 4QN
Tel: +44 (0)1934 876 100
Fax: +44 (0)1934 835 169
www.smartsystems.co.uk

CHECKED			
PRODUCT CODE			
MATERIAL			
	ISSUE	MOD No.	DESCRIPTION
	DATE	JULY_2010	
	SCALE	N.T.S.@A3	
			DRAWING No.

No unauthorised use, copy or disclosure of this drawing is to be made.
It is to be returned whenever required.

ISSUE	MOD No.	DATE

ETD024N

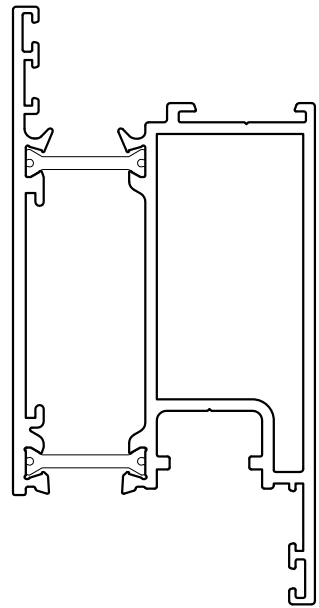

ETD047

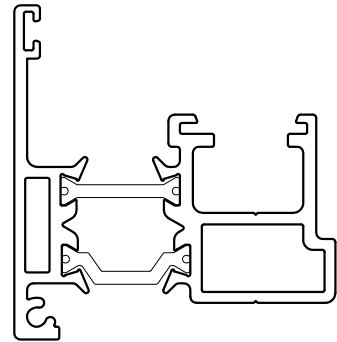

ETD025N

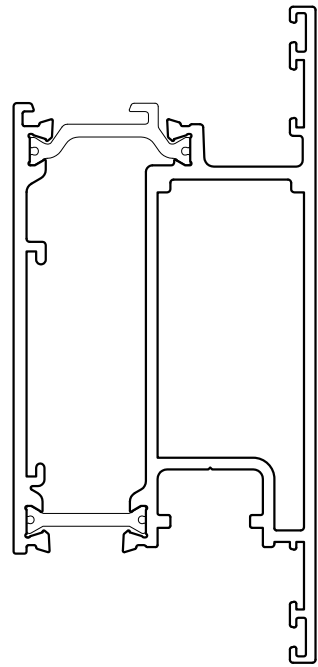

ETD033

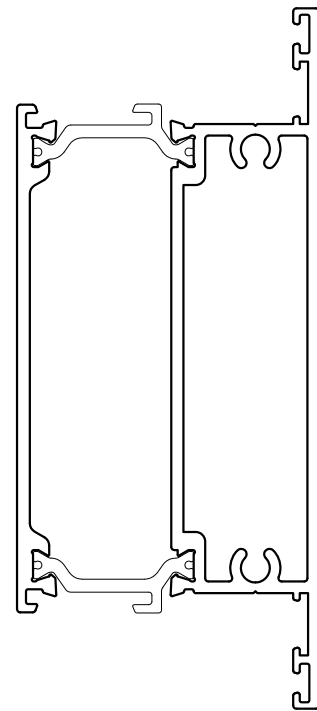

ETD030

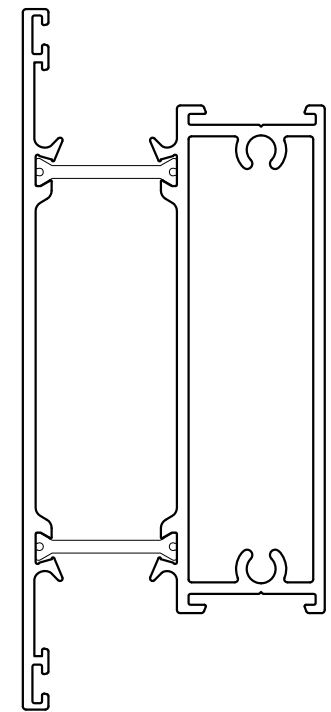

ETD017

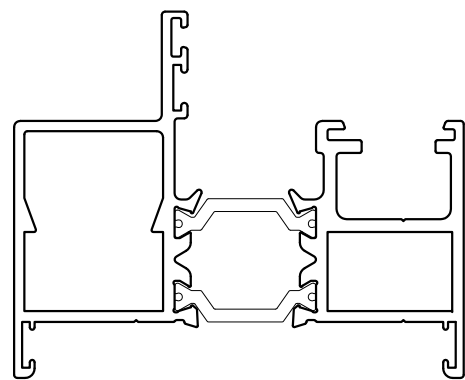

ETD034

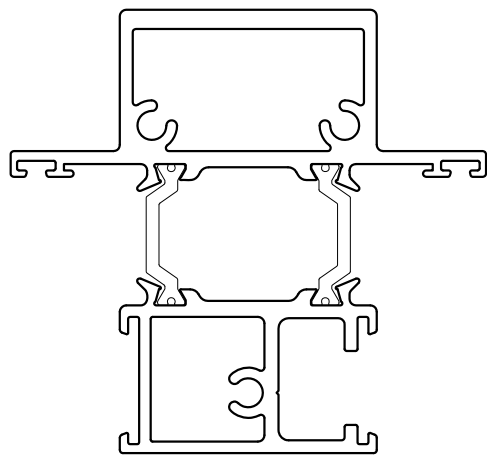

ETD012

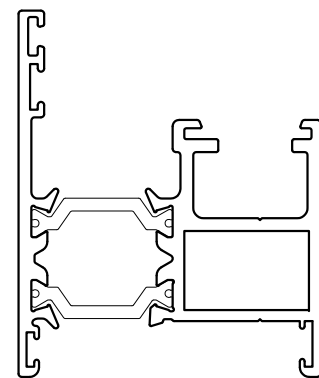

ETD096

ECZ65

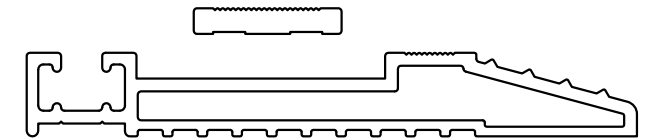

ETD048

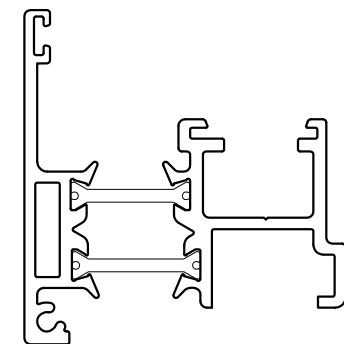

ETD097

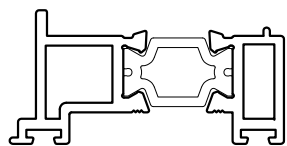

TITLE

Alitherm Plus Door - Wall Charts

smart
architectural aluminium

Smart Systems Limited
Arnolds Way, Yatton,
North Somerset,
BS49 4QN
Tel: +44 (0)1934 876 100
Fax: +44 (0)1934 835 169
www.smartsystems.co.uk

CHECKED				
PRODUCT CODE				
MATERIAL	ISSUE	MOD No.	DESCRIPTION	DATE
	DRAWN	DRAWN		DRAWING No.
	DATE	JULY_2010		
	SCALE	N.T.S.@A3		

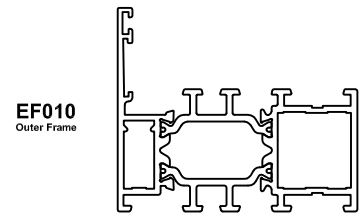

EF010
Outer Frame

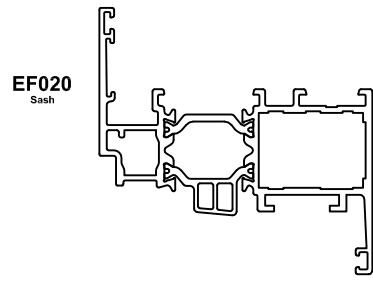

EF020
Sash

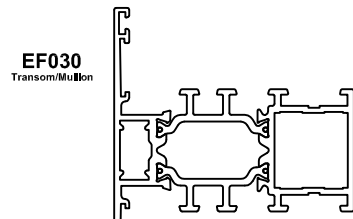

EF030
Transom/Mullion

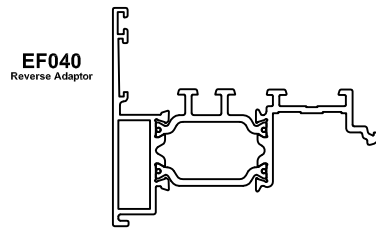

EF040
Reverse Adaptor

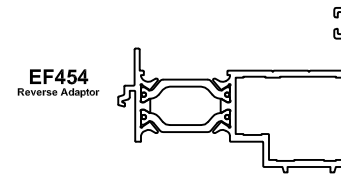

EF454
Reverse Adaptor



VL59
Link Rod

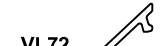

VL72
Link Rod

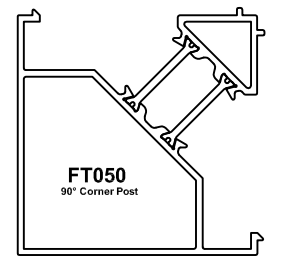

FT050
90° Corner Post

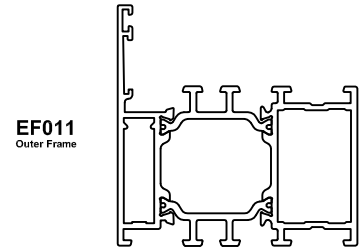

EF011
Outer Frame

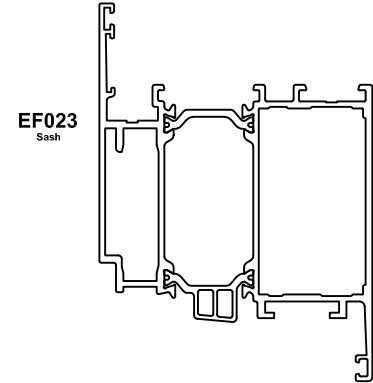

EF023
Sash

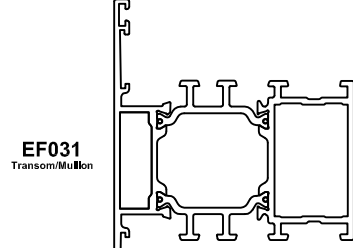

EF031
Transom/Mullion

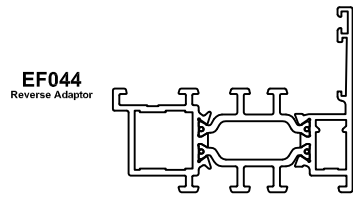

EF044
Reverse Adaptor



EF455
??????????

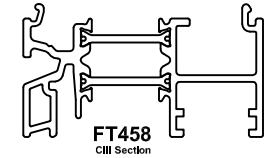

FT458
Cill Section

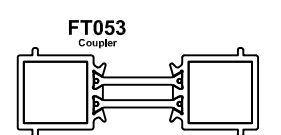

FT053
Coupler

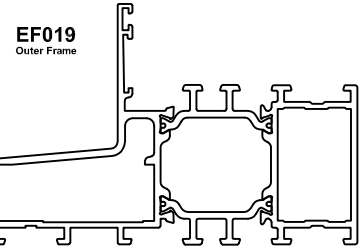

EF019
Outer Frame

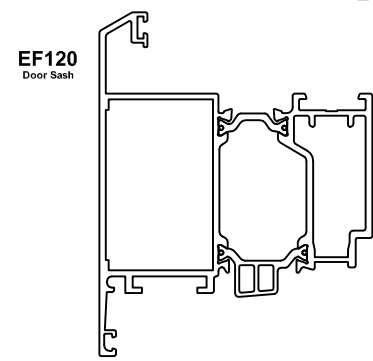

EF120
Door Sash

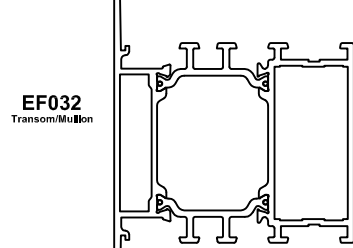

EF032
Transom/Mullion

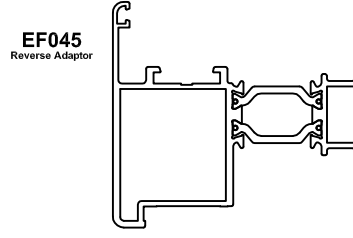

EF045
Reverse Adaptor

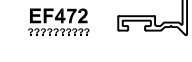

EF472
??????????



EF473
??????????

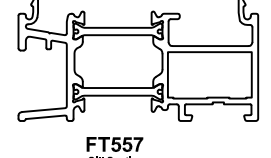

FT557
Cill Section

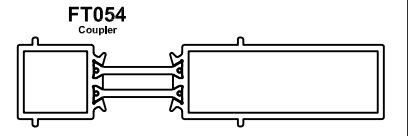

FT054
Coupler

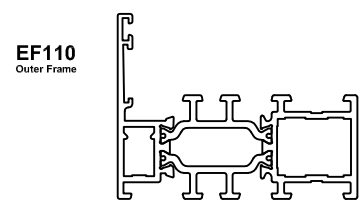

EF110
Outer Frame

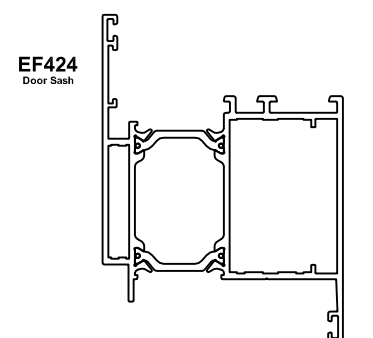

EF424
Door Sash

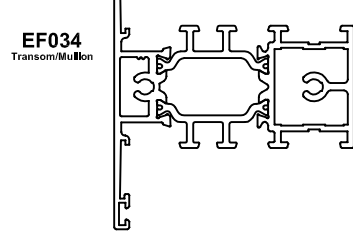

EF034
Transom/Mullion

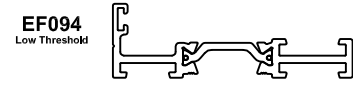

EF094
Low Threshold



EF095
Drip Section

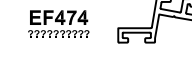

EF474
??????????



EF475
??????????



EF476
??????????



FT055
???????

FT056
???????

FT057
???????

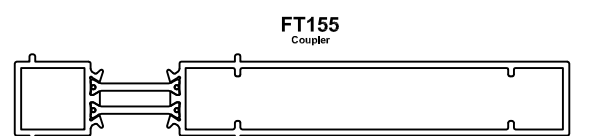

FT155
Coupler

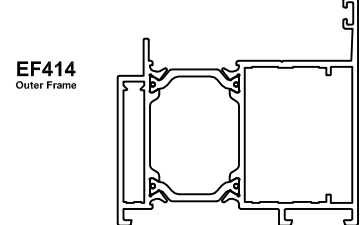

EF414
Outer Frame

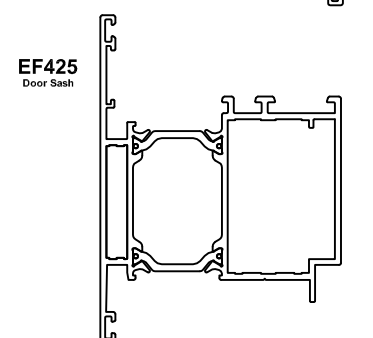

EF425
Door Sash

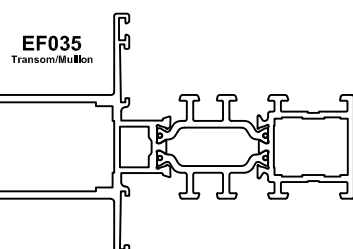

EF035
Transom/Mullion

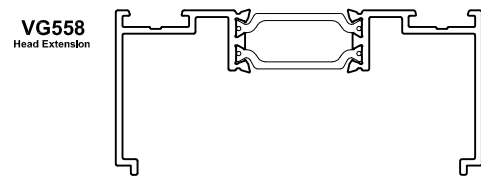

VG558
Head Extension

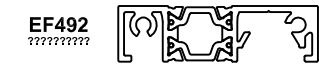

EF492
??????????

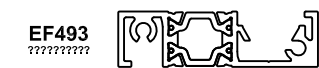

EF493
??????????

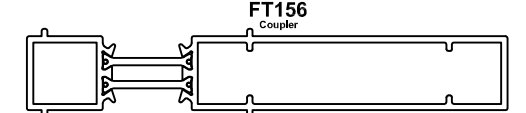

FT156
Coupler

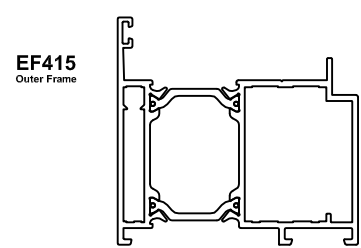

EF415
Outer Frame

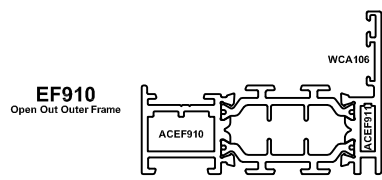

EF910
Open Out Outer Frame



EF657
??????????



UN500
??????????

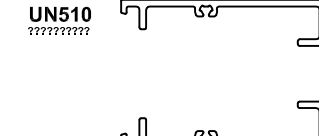

UN510
??????????



VL479
Cill Extension



VL480
Cill Extension



VL481
Cill Extension



VL482
Cill Extension



VL483
Cill Extension

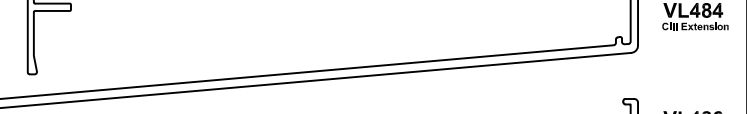

VL484
Cill Extension

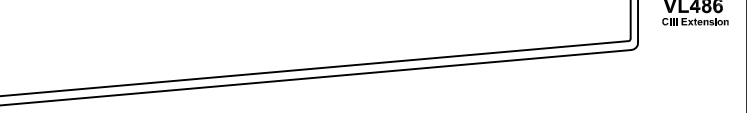

VL486
Cill Extension

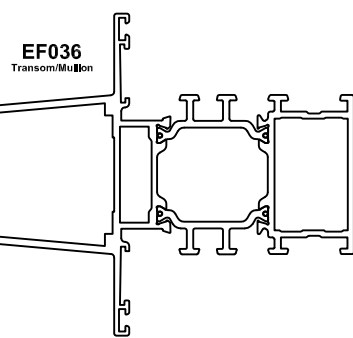

EF036
Transom/Mullion

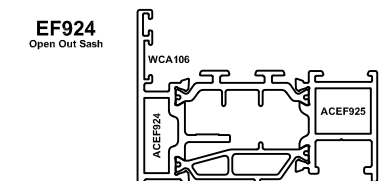

EF924
Open Out Sash

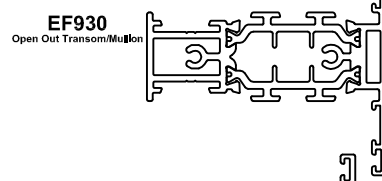

EF930
Open Out Transom/Mullion

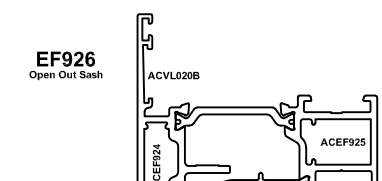

EF926
Open Out Sash

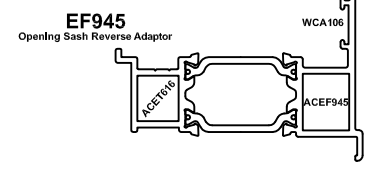

EF945
Opening Sash Reverse Adaptor

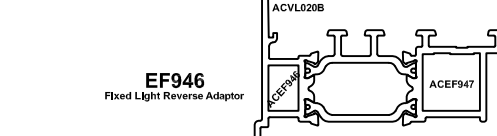

EF946
Fixed Light Reverse Adaptor

VISION / VN

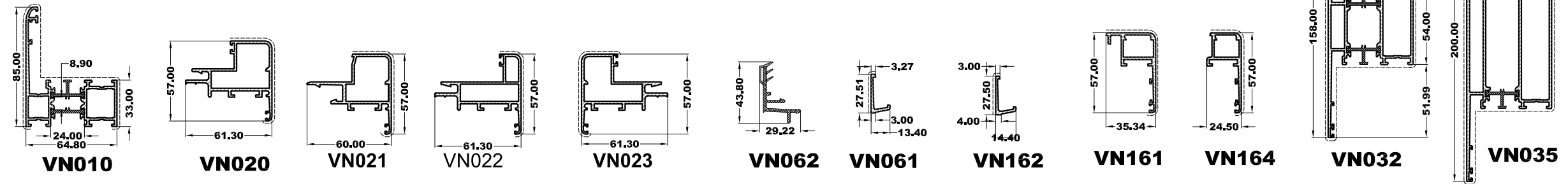

FLYSCREEN / F

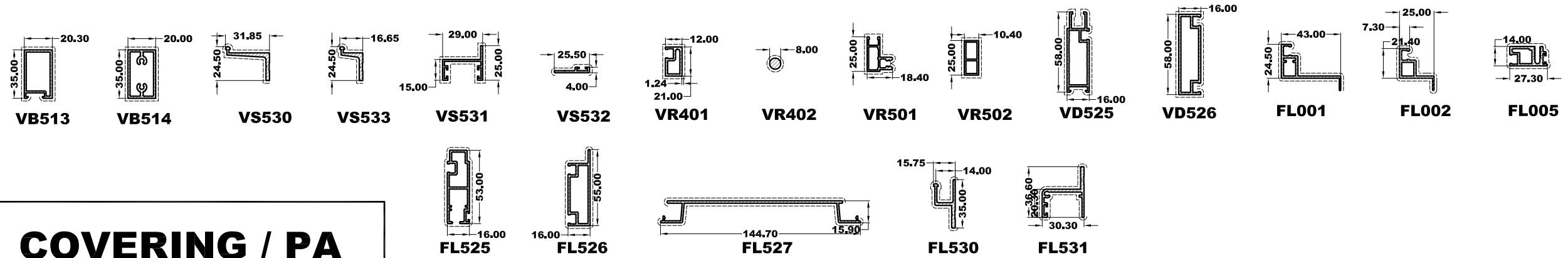

COVERING / PA

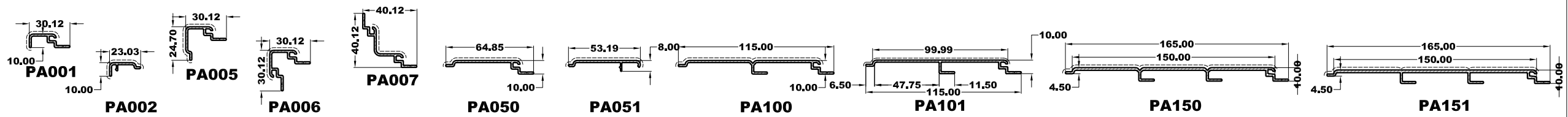

VISOFOLD / DV

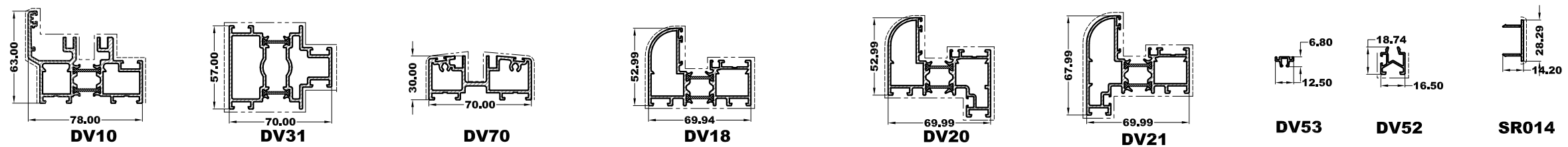

08/02/1999

TITLE

Vision / Flyscreen / Covering / Visofold - Wall Chart

smart
architectural aluminium

Smart Systems Limited
Arnolds Way, Yatton,
North Somerset,
BS49 4QN
Tel: +44 (0)1934 876 100
Fax: +44 (0)1934 835 169
www.smartsystems.co.uk

CHECKED			
PRODUCT CODE			
MATERIAL	ISSUE MOD No.	DESCRIPTION	DATE
	DRAWN	DRAWN	DRAWING No.
	DATE	JULY_2010	
	SCALE	N.T.S.@A3	

VISOLINE / VL

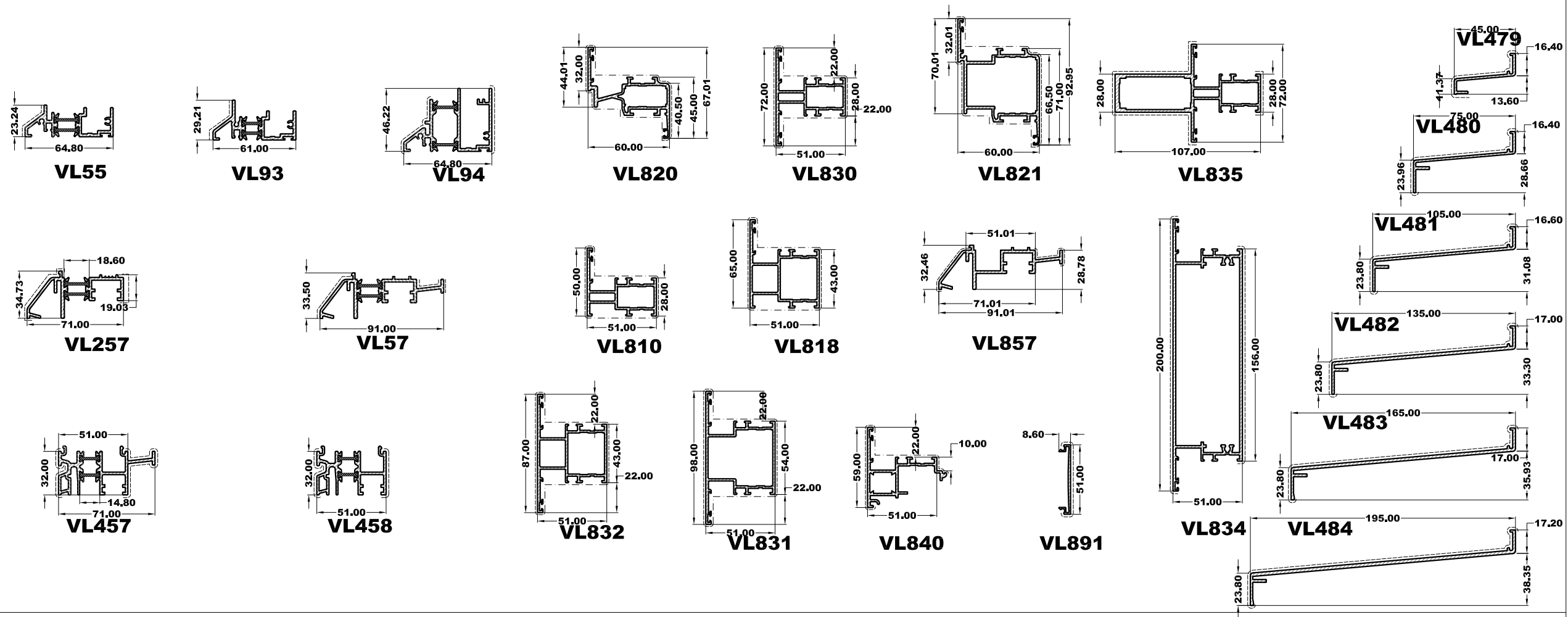

EMINENT / EM

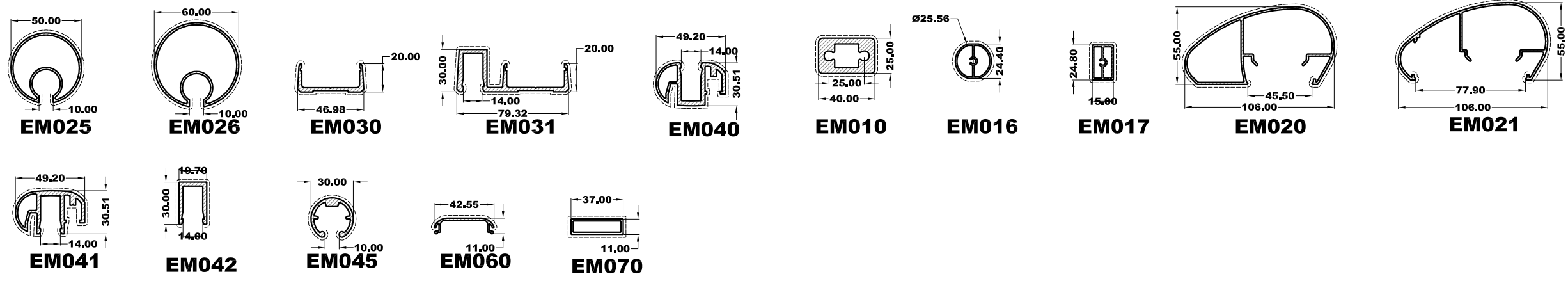

15/02/1999

TITLE

Visoline / Eminent - Wall Chart



Smart Systems Limited
Arnolds Way, Yatton,
North Somerset,
BS49 4QN
Tel: +44 (0)1934 876 100
Fax: +44 (0)1934 835 169
www.smartsystems.co.uk

CHECKED			
PRODUCT CODE			
MATERIAL	DRAWN	DATE	DRAWING No.
	DRAWN	JULY 2010	
	SCALE	N.T.S.@A3	

VISOLINE / VL

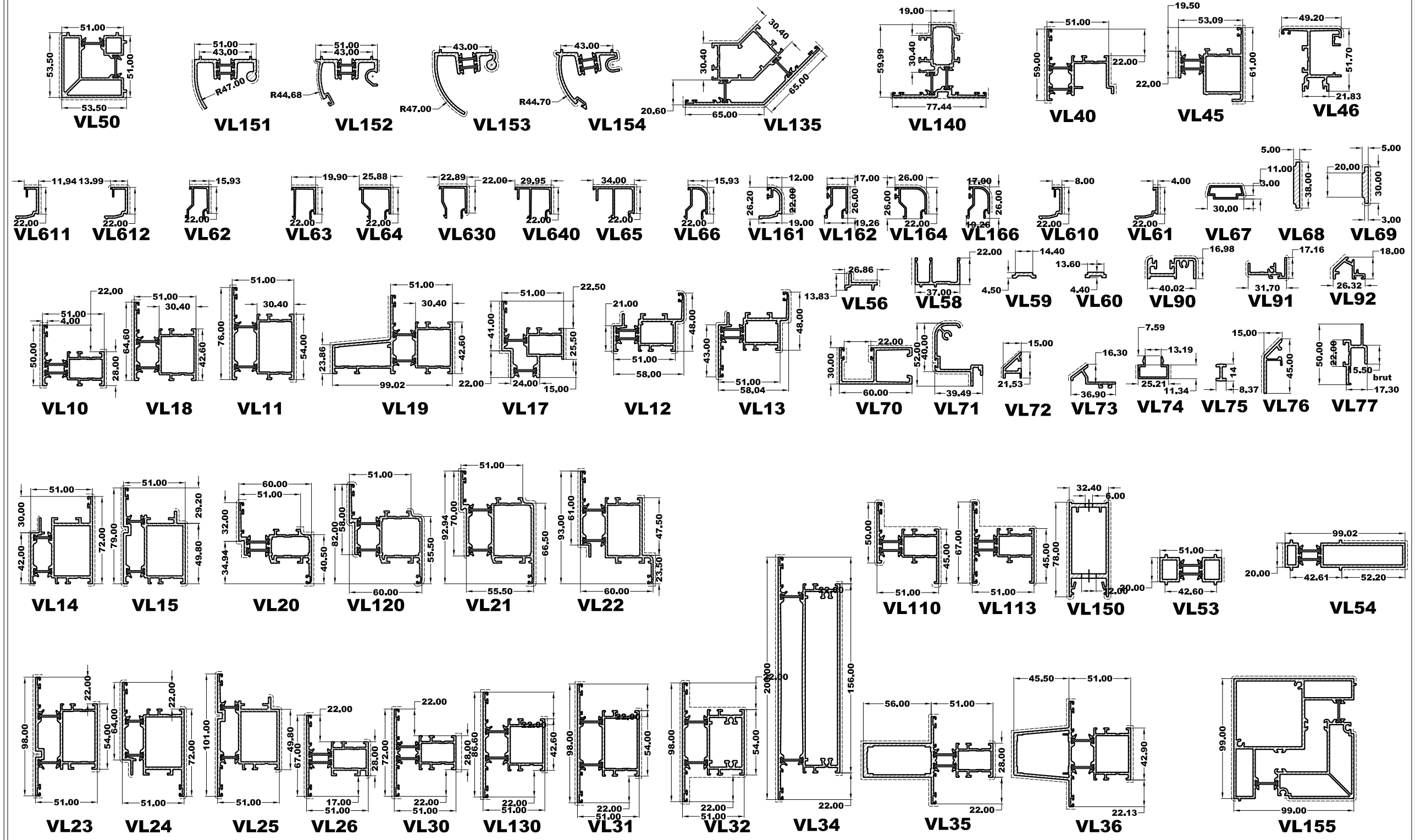

15/02/1999

TITLE

Visoline - Wall Chart

smart
architectural aluminium

Smart Systems Limited
Arnolds Way, Yatton,
North Somerset,
BS49 4QN
Tel: +44 (0)1934 876 100
Fax: +44 (0)1934 835 169
www.smartsystems.co.uk

CHECKED			
PRODUCT CODE			
MATERIAL	ISSUE MOD No.	DESCRIPTION	DATE
	DRAWN	DRAWN	DRAWING No.
	DATE	JULY_2010	
	SCALE	N.T.S.@A3	

VISOGLIDE / VG

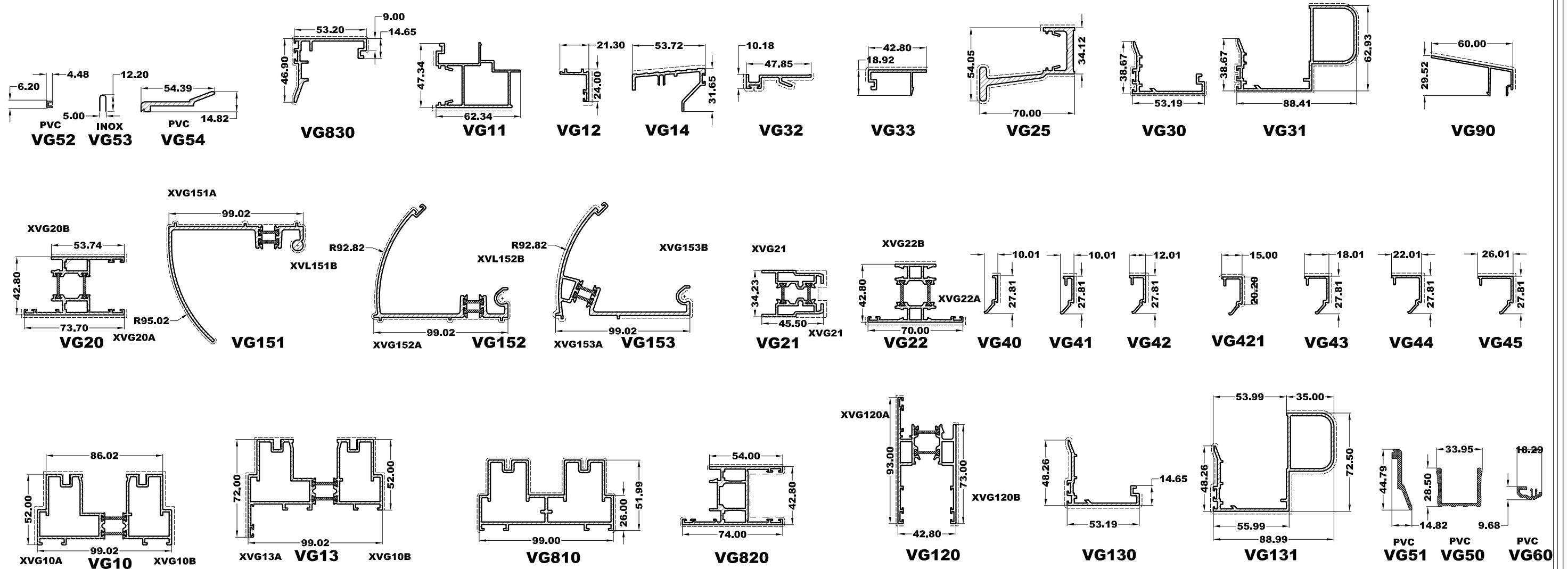

15/02/1999

TITLE

Visoglide - Wall Chart

smart
architectural aluminium

Smart Systems Limited
Arnolds Way, Yatton,
North Somerset,
BS49 4QN
Tel: +44 (0)1934 876 100
Fax: +44 (0)1934 835 169
www.smartsystems.co.uk

CHECKED

PRODUCT CODE

MATERIAL

ISSUE MOD No.	DESCRIPTION	DATE
DRAWN	DRAWN	DRAWING No.
DATE	JULY_2010	
SCALE	N.T.S.@A3	

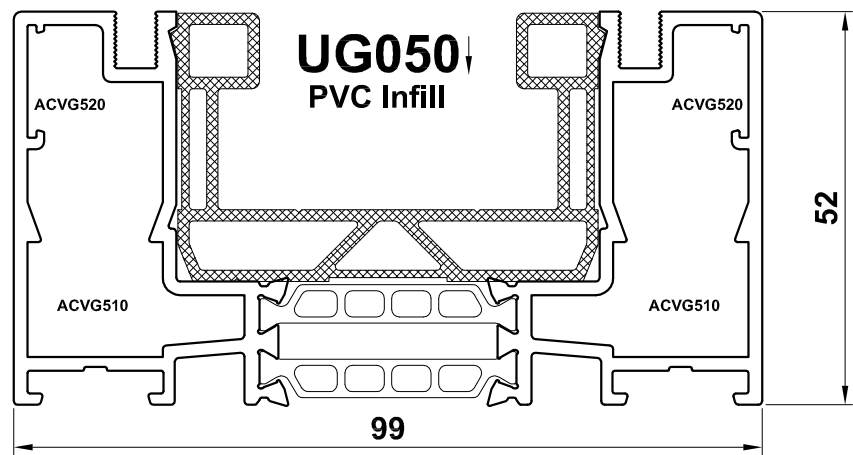

VG510 →
Two Track
Outer Frame

VG512 →
Three Track
Outer Frame

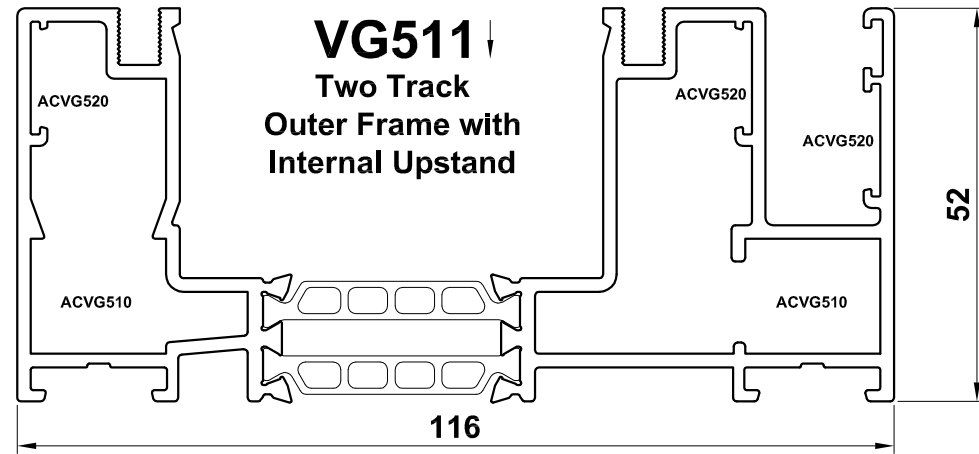
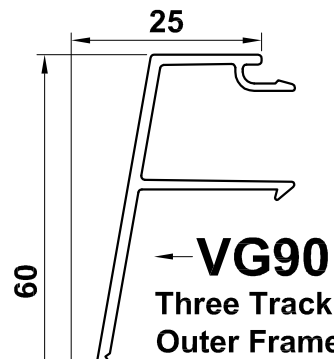
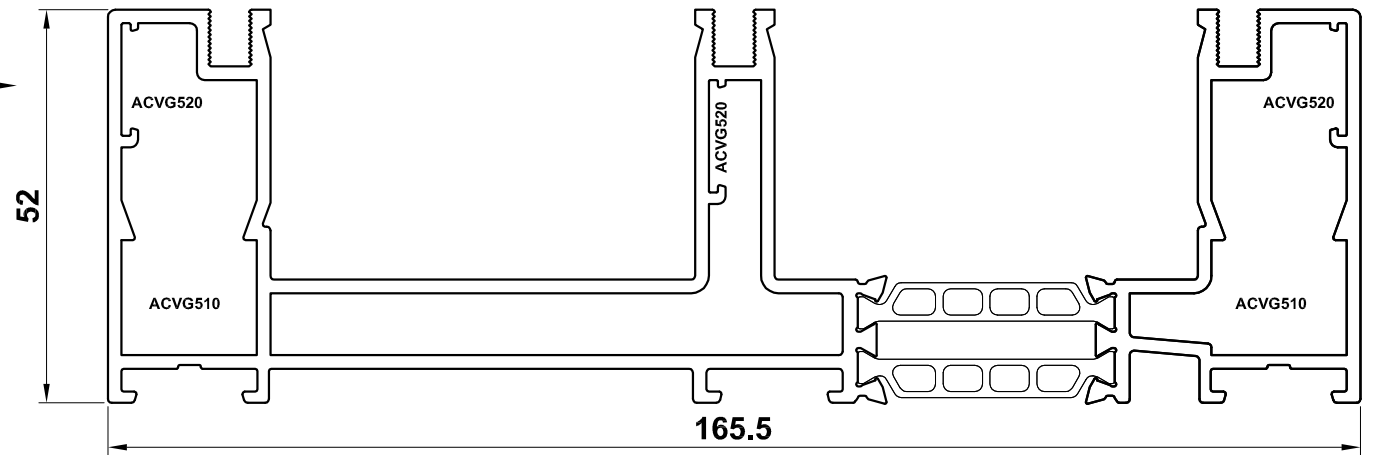

VG514 ↓
2 Track Cover

VG515 ↓
3 Track Cover

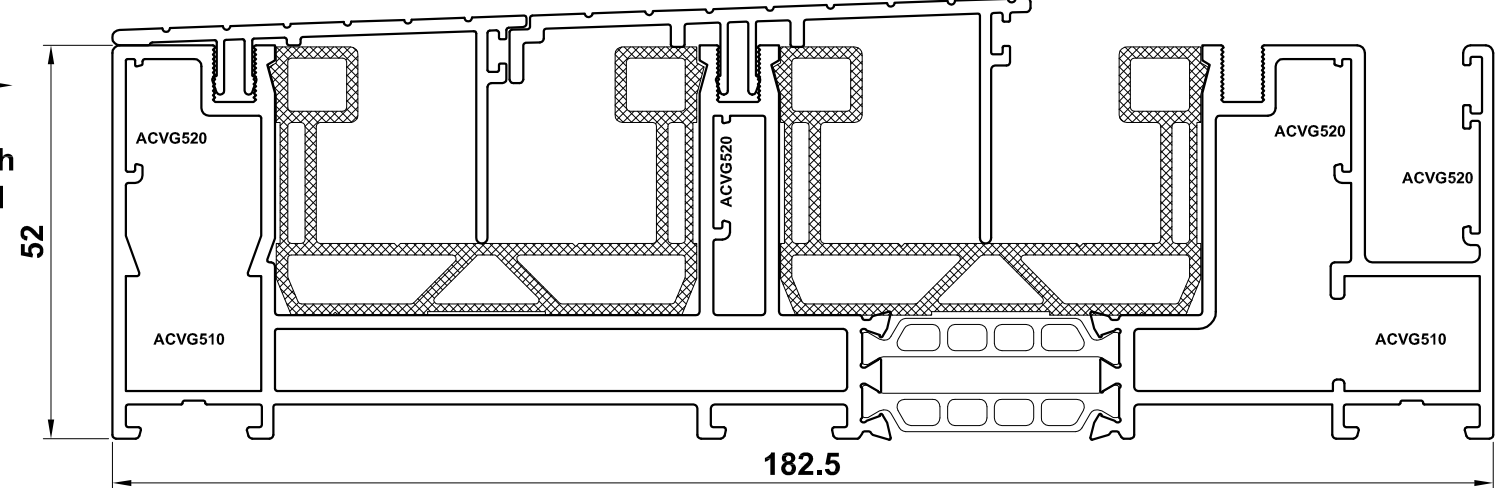

VG513 →
Three Track
Outer Frame with
Internal Upstand

VG532 ↓
Reinforcing Section

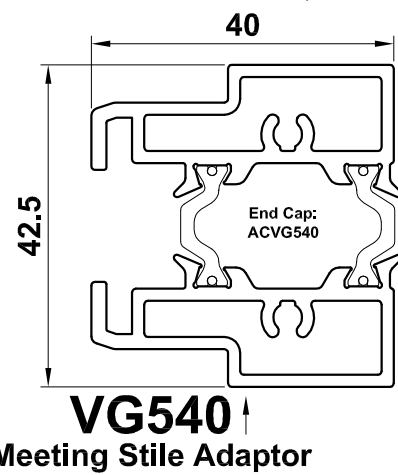
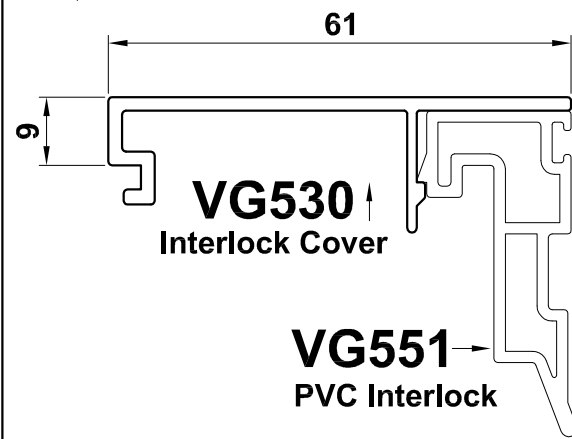
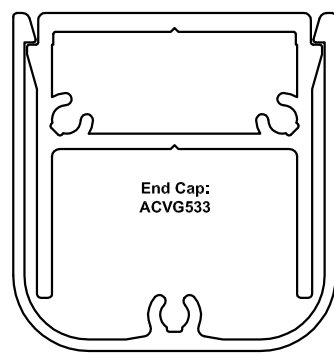

VG533 ↑
VG532 Cover Cap

VG557 →
Frame Extension

VG556 →
Drainage Tray

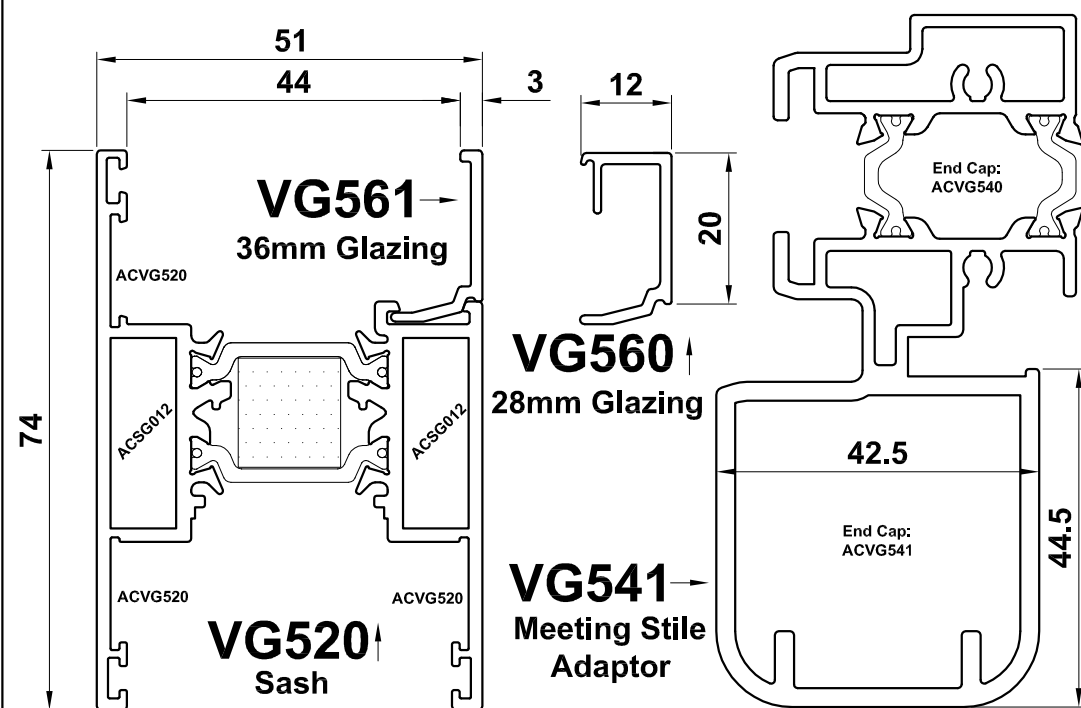
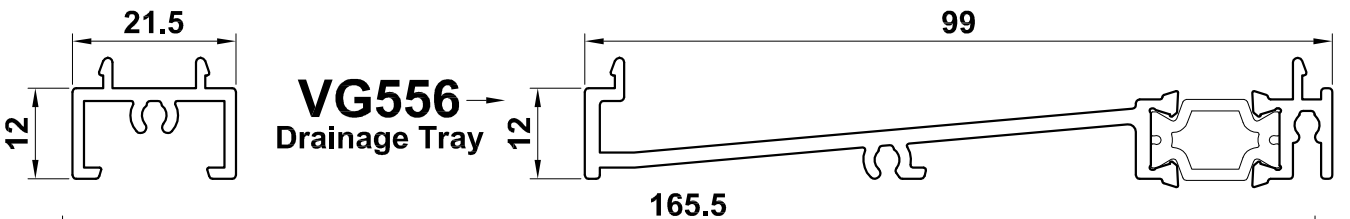

VG52 →
PVC Infill

VG53 →
Stainless Steel Track

VG559 ↑
VG512
Head Extension

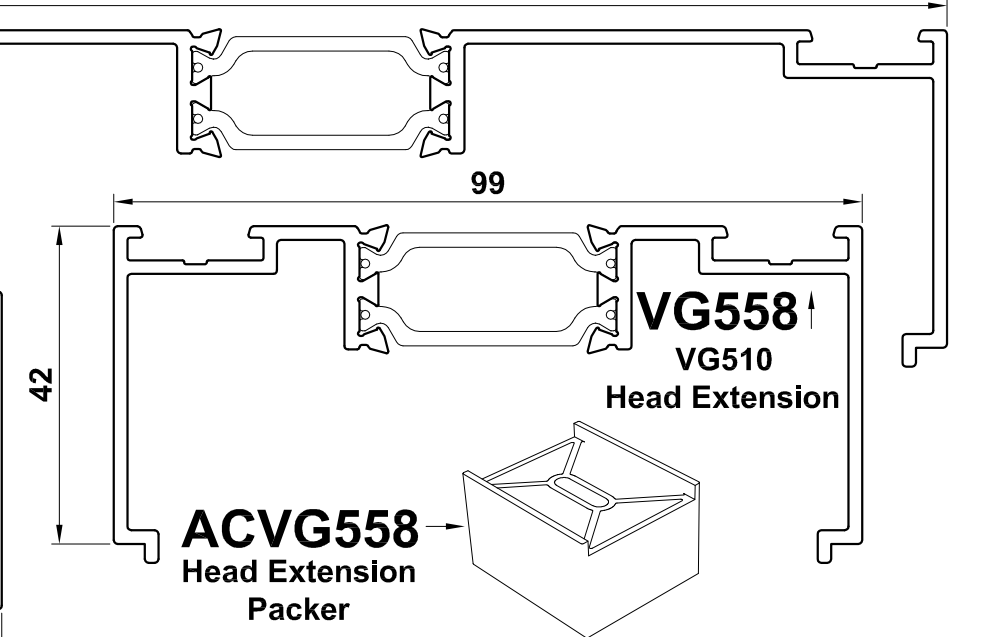
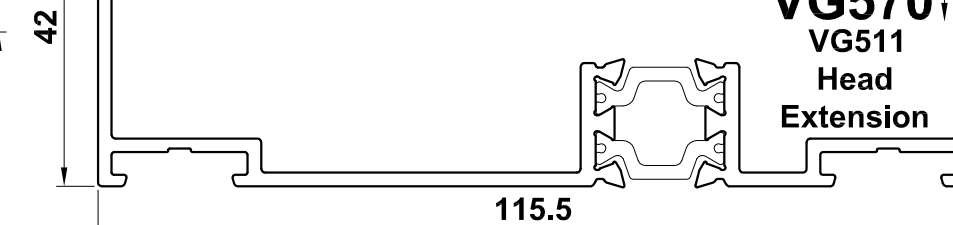

ACVS033 →
4.8 x 9 Black
Woolpile with Fin

ACVG557 →
Bridge Packer

smart
architectural aluminium

System:
Visoglide Plus
Copyright Smart Systems Ltd.

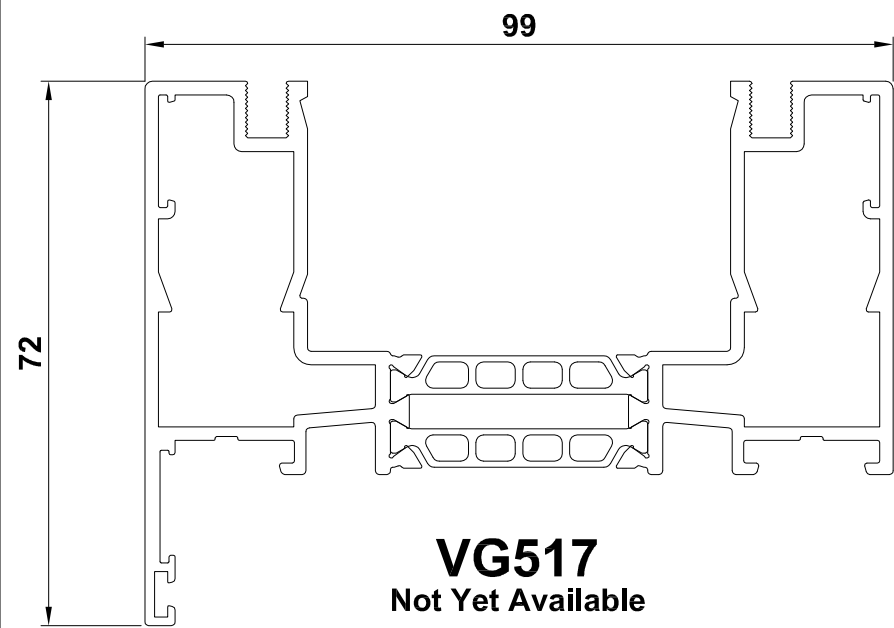

VG517
Not Yet Available

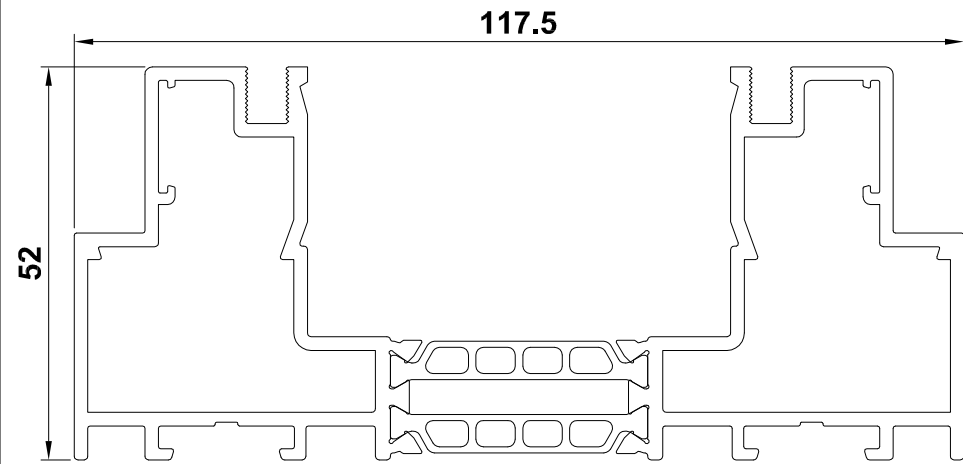

VG518
Not Yet Available

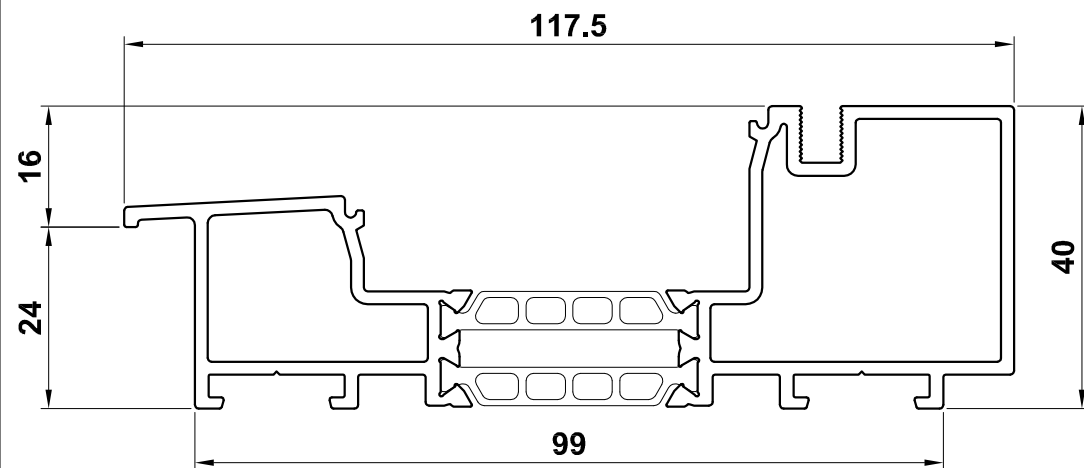

VG516
Mono Rail Threshold

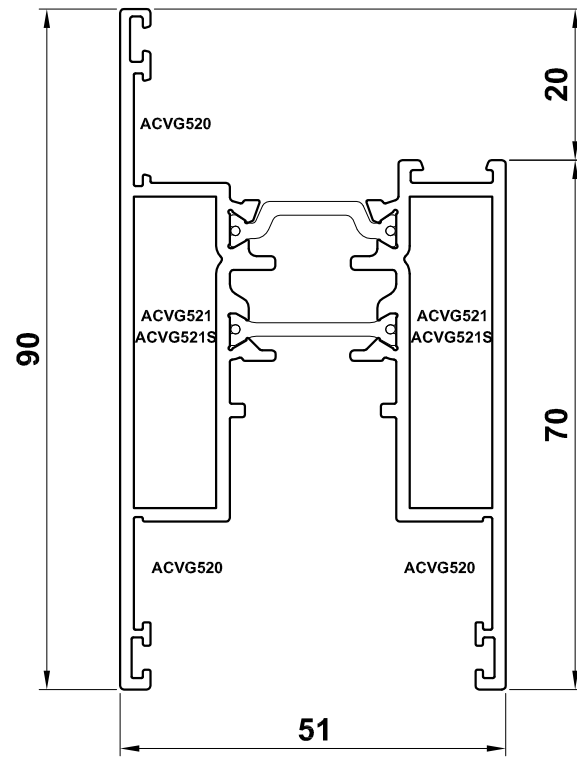

VG521
Lift & Slide Sash

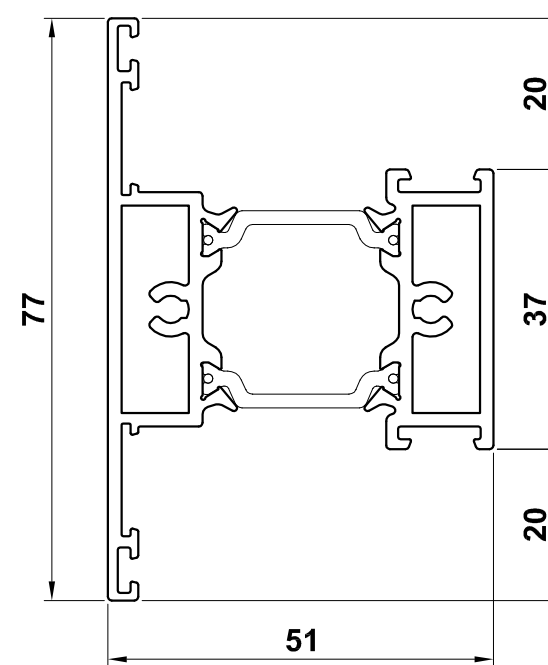

VG525
Sash Transom

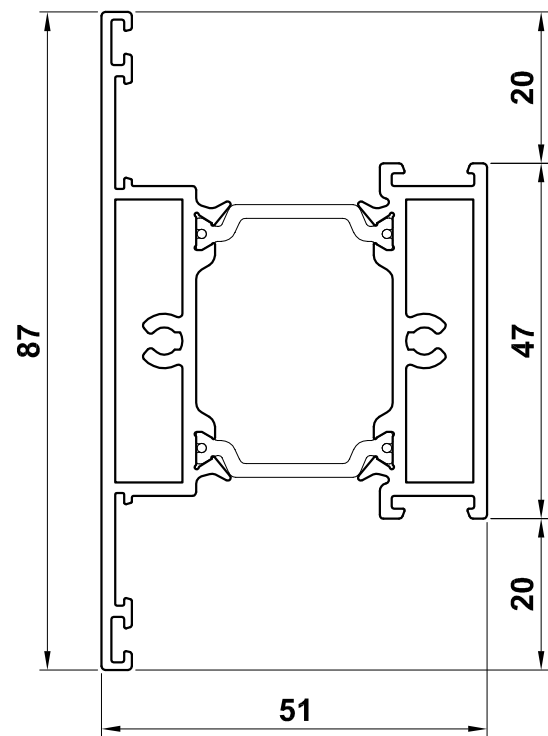

VG526
Wide Sash Transom

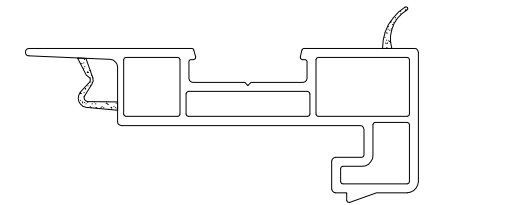

VG553
Mono Rail Interlock

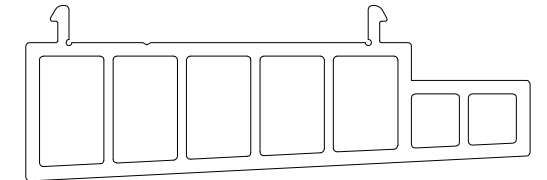

VG554
Mono Rail Infill

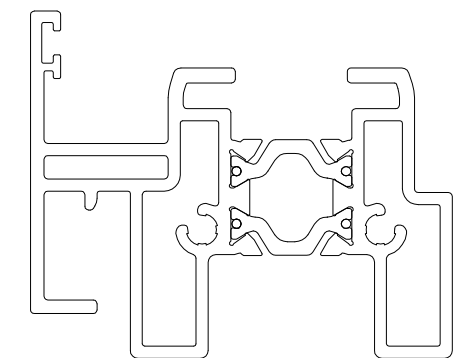

VG542
Not Yet Available

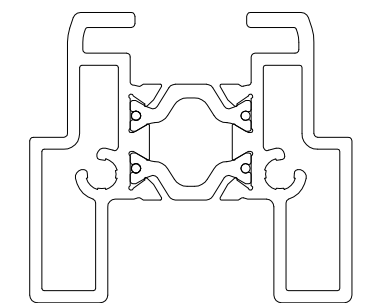

VG543
Not Yet Available

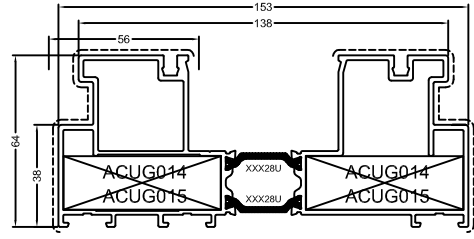

UG010

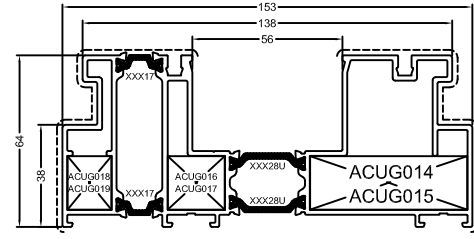

UG011

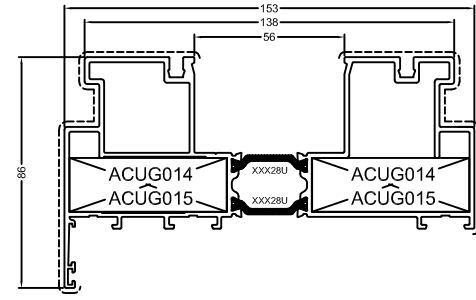

UG012

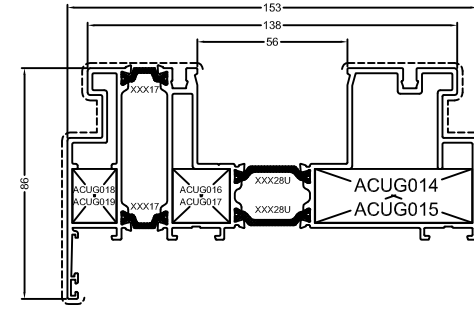

UG013

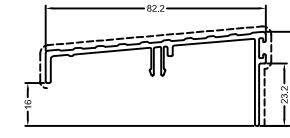

UG014

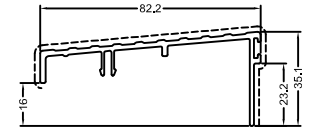

UG015

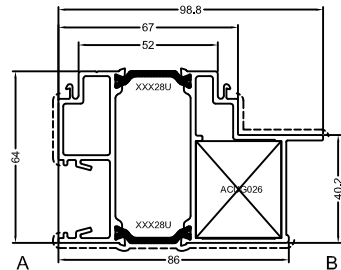

UG016

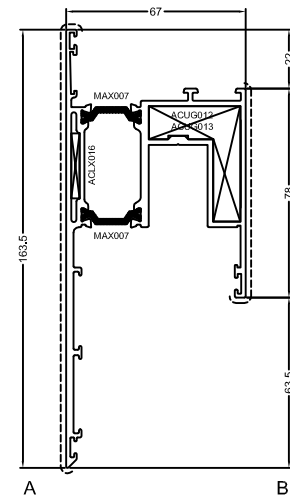

UG021

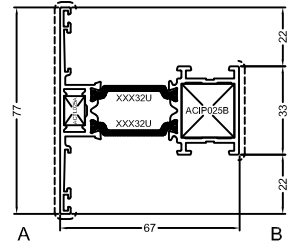

UG025

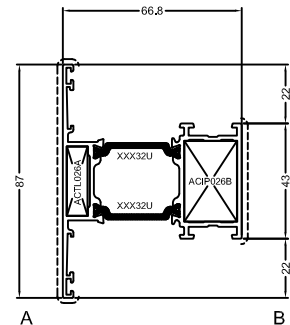

UG026

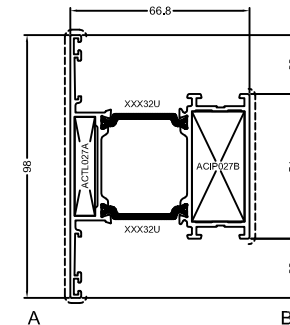

UG027

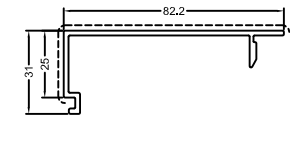

UG030

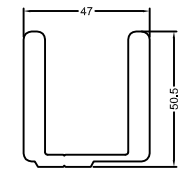

UG031

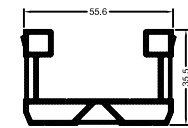

UG050

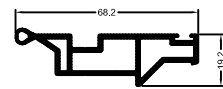

UG051



UG060

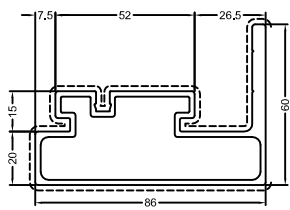

UG032

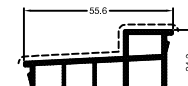

UG054



UG055

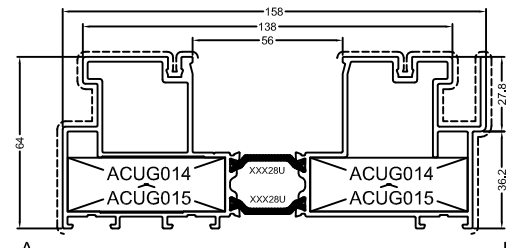

UG110

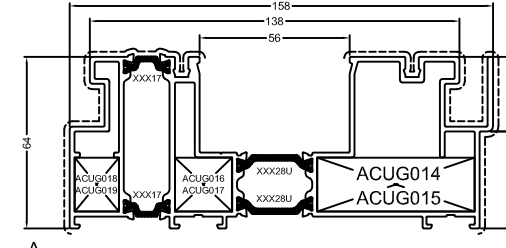

UG111

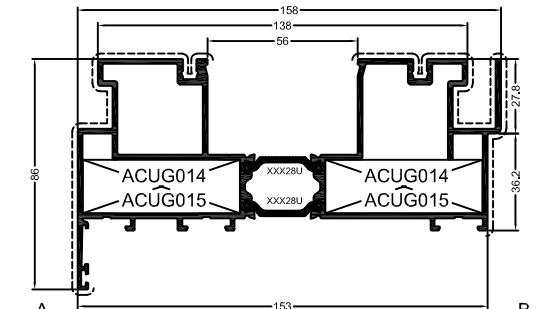

UG112

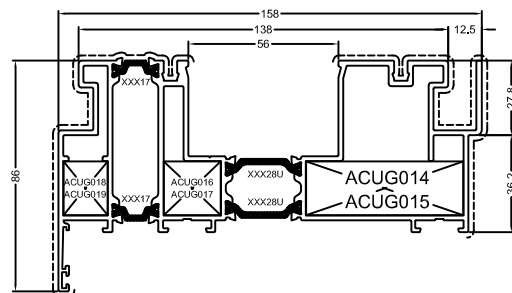

UG113

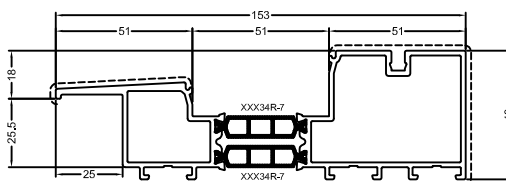

UG114

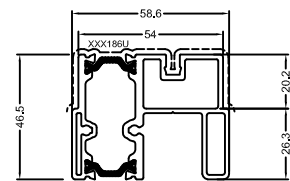

UG141

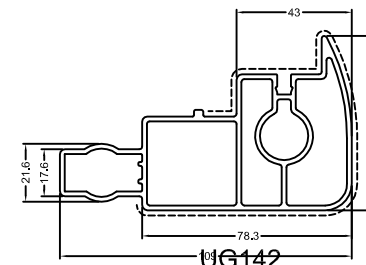

UG142

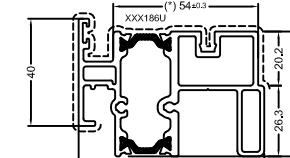

UG143

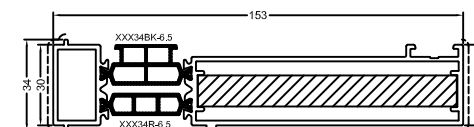

UG150

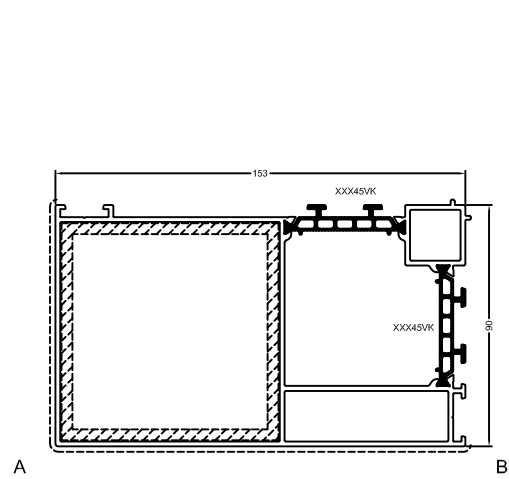

UG154

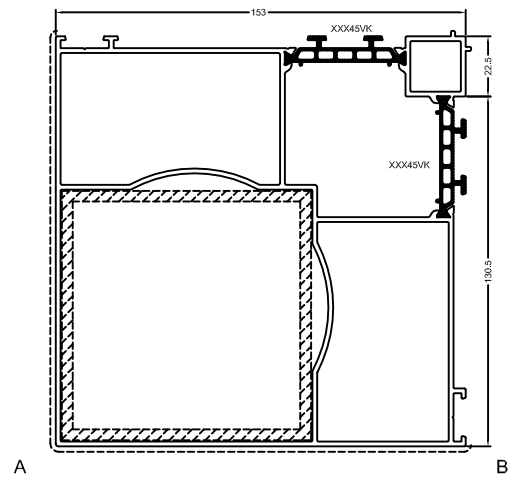

UG155

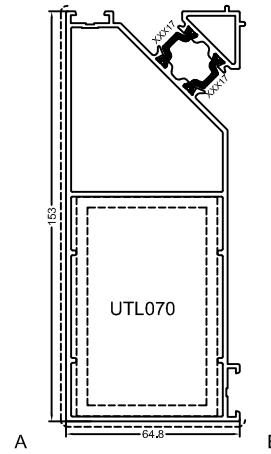

UG156

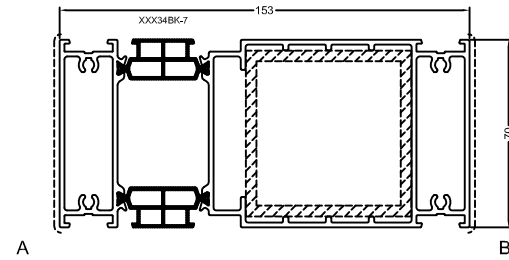

UG176

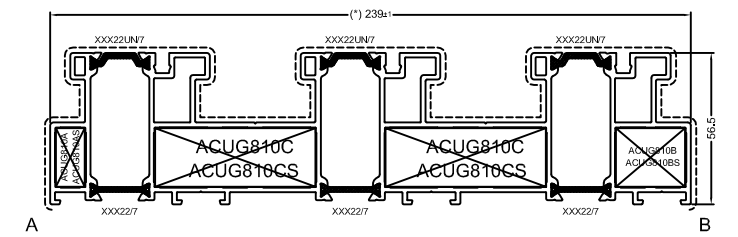

UG210

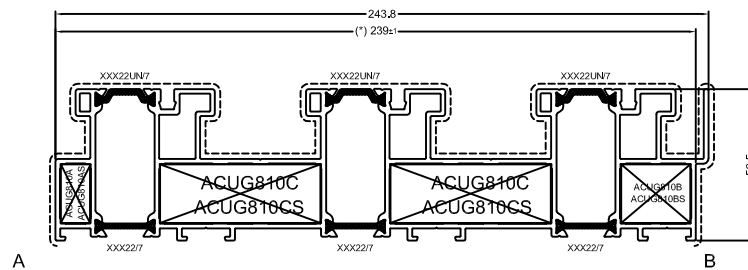

UG212

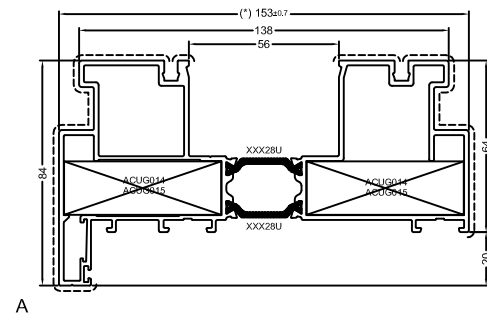

UG310

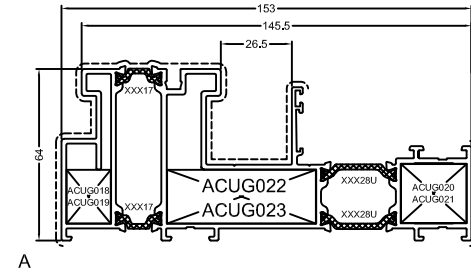

UG610

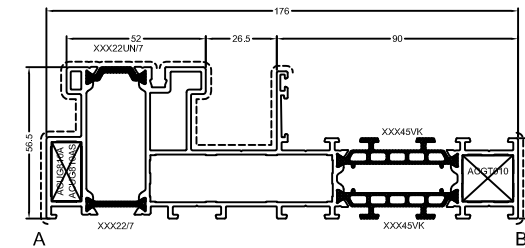

UG611

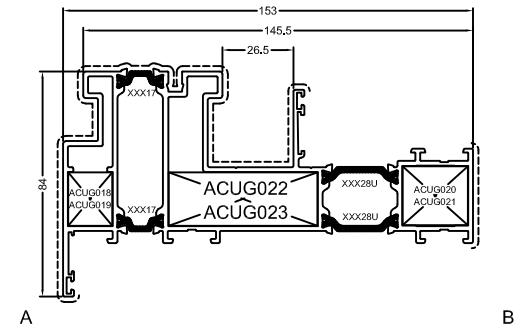

UG612

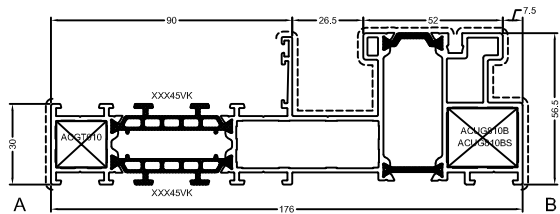

UG613

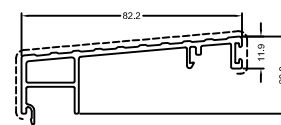

UG614

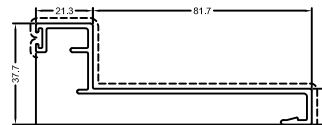

UG615

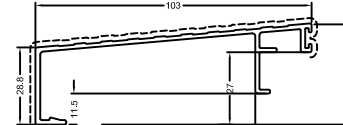

UG616

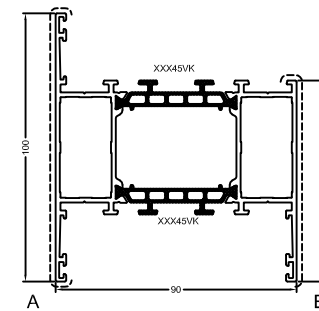

UG620

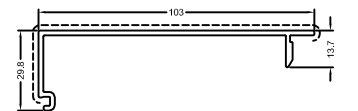

UG630

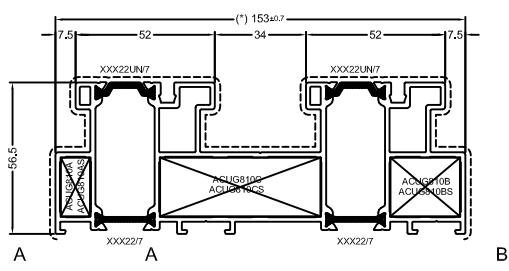

UG810

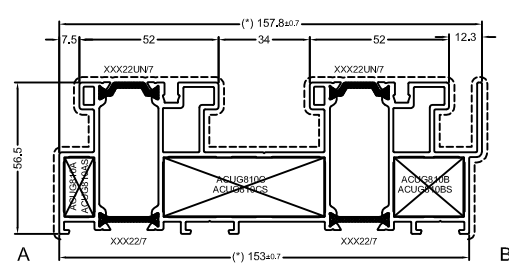

UG812

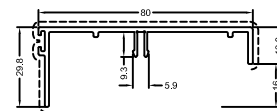

UG814

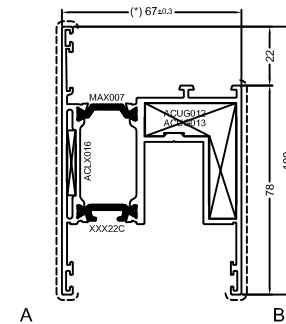

UG820

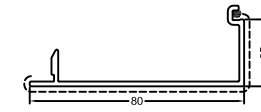

UG830

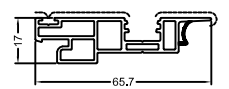

UG851

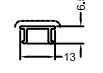

UG852

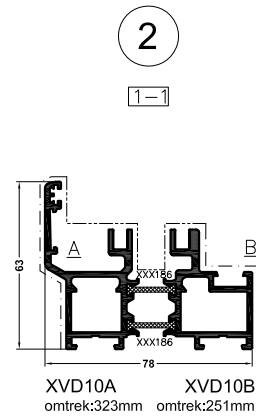

DV10
omtrek: 488mm

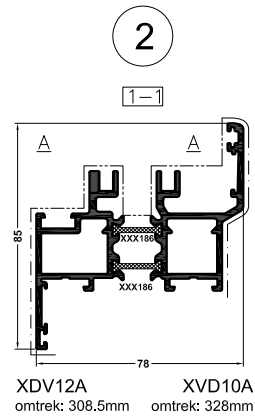

DV12
omtrek: 586.5mm

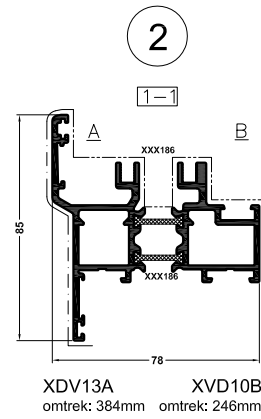

DV13
omtrek: 586.12mm

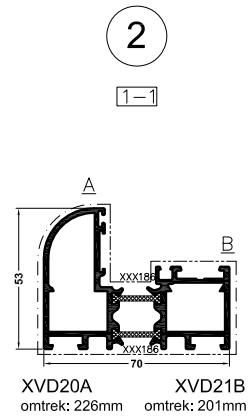

DV18
omtrek: 362mm

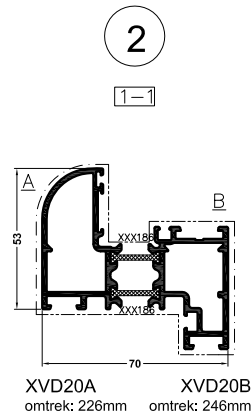

DV20
omtrek: 389mm

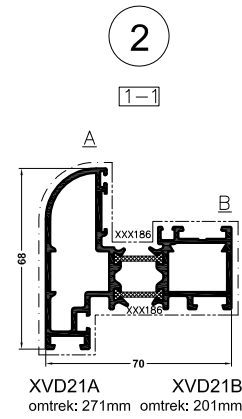

DV21
omtrek: 389mm

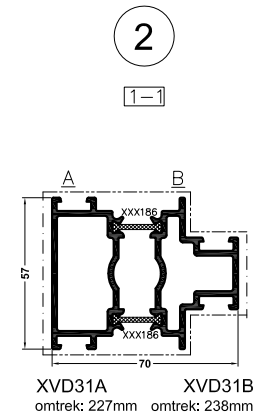

DV31
omtrek: 323mm

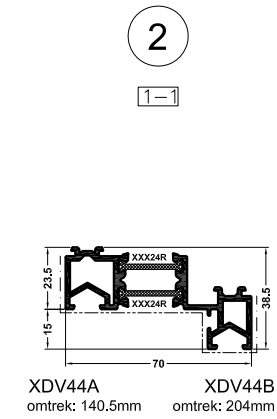

DV44
omtrek: 320.9mm



DV52
omtrek: 131mm



DV53
omtrek: 57mm

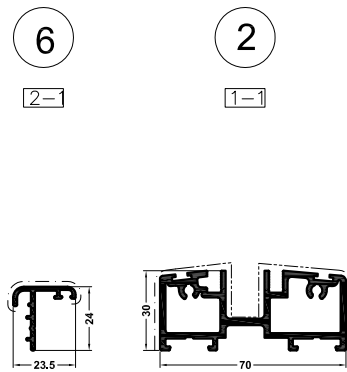

DV56 omtrek: 131mm
DV70 omtrek: 347mm

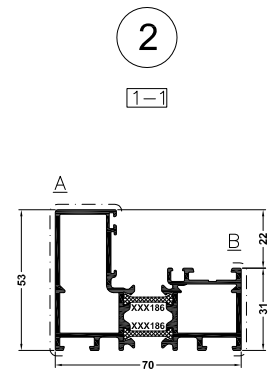

DV118
omtrek: 392.5mm

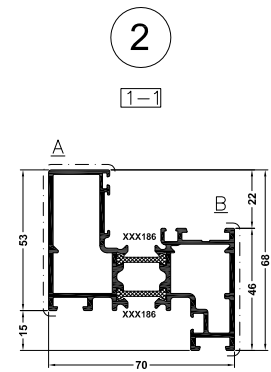

DV120
omtrek: 437.1mm

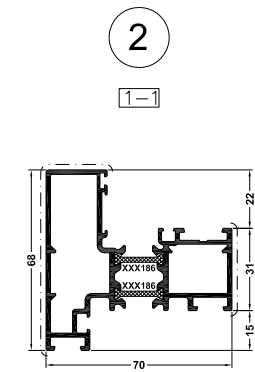

DV121
omtrek: 437.7mm

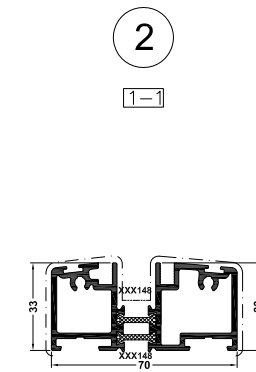

DV170
omtrek: 364.3mm

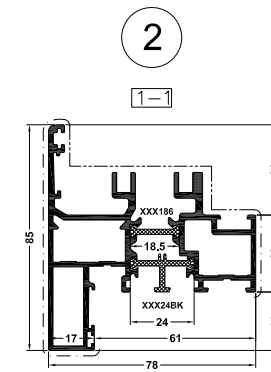

DV313
omtrek: 634.4mm

TITLE

Visofold DV - Wall Chart



Smart Systems Limited
Arnolds Way, Yatton,
North Somerset,
BS49 4QN
Tel: +44 (0)1934 876 100
Fax: +44 (0)1934 835 169
www.smartsystems.co.uk

CHECKED				
PRODUCT CODE				
MATERIAL	ISSUE	MOD No.	DESCRIPTION	DATE
	DRAWN	D.N.		DRAWING No.
	DATE	JULY_2010		
	SCALE	N.T.S.@A3		

DV14
Outer Frame

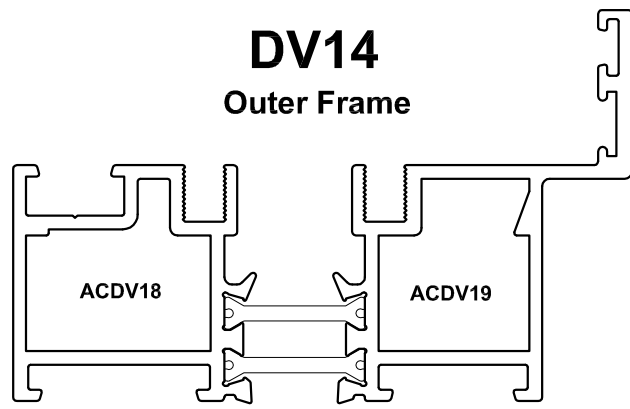

DV172
Flush Drainage Cill

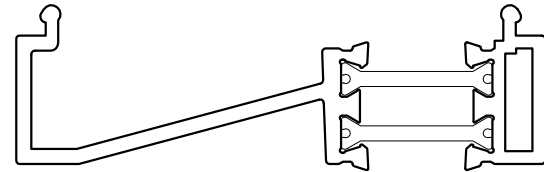

DV30
Transom

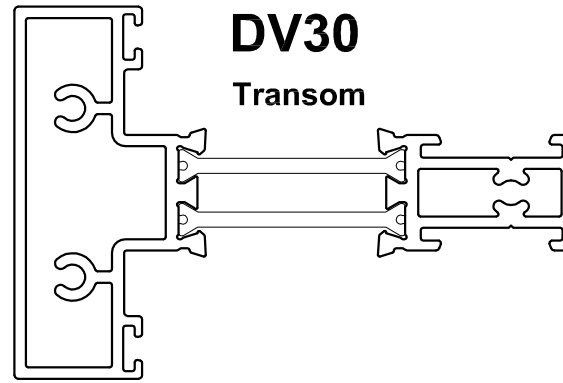

DV515
Frame Extension

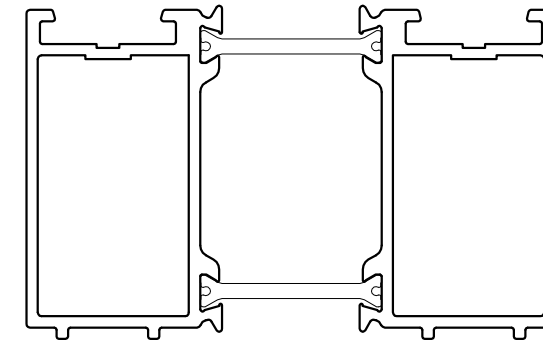

PCX36
DV23 & DV26
Lock Channel

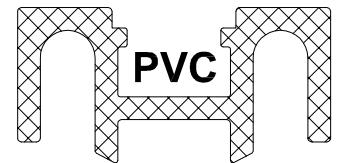

PCX38
DV28 & DV29
Lock Channel



DV32
Floating Mullion

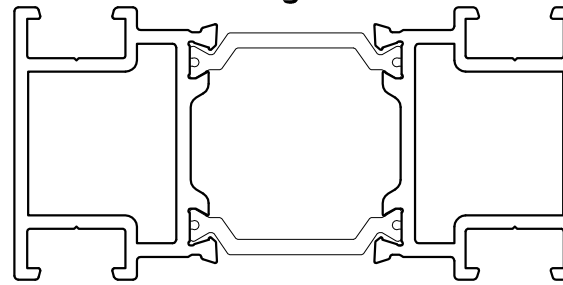

DV559
Frame Extension

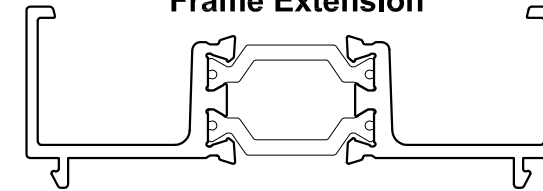

PCX15
Infill
PVC



DV23
Square Sash

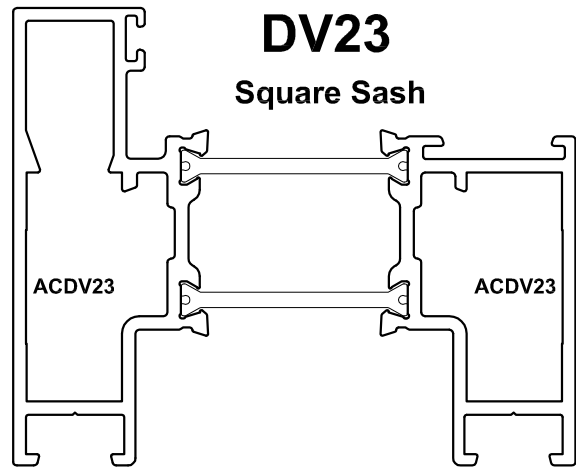

DV28
Square Sash for Flat
Handles

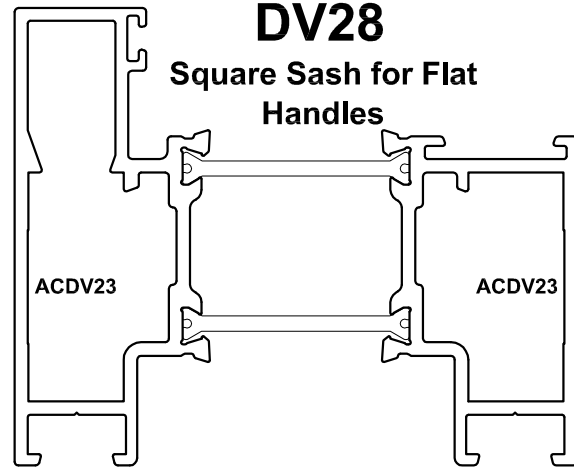

VG52
Infill Strip



VG53
Track



**Stainless
Steel**

DV56
End Cap = ACDV56

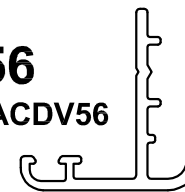

DV60
Infill Strip



DV62
Woolpile Carrier



DV26
Curved Sash

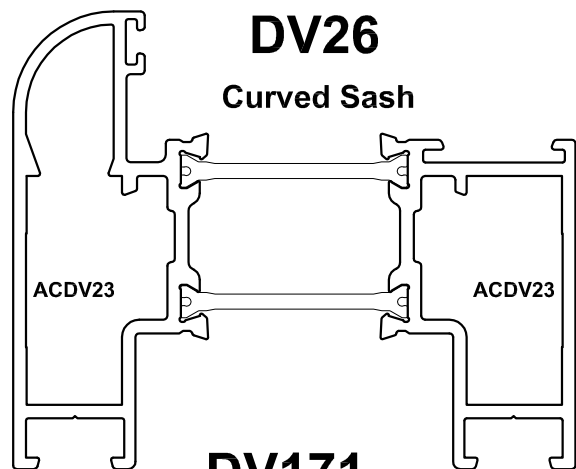

DV29
Curved Sash for Flat
Handles

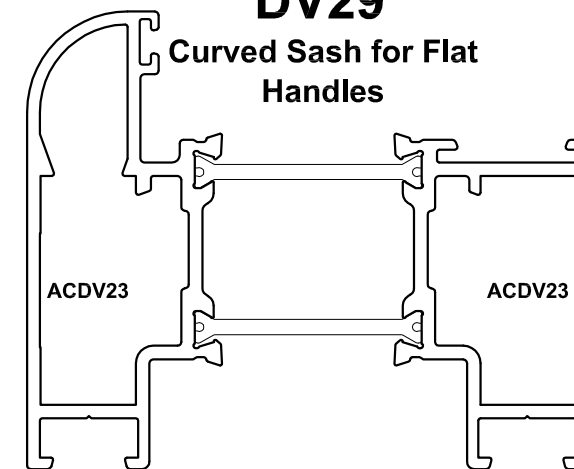

DV35
Transom

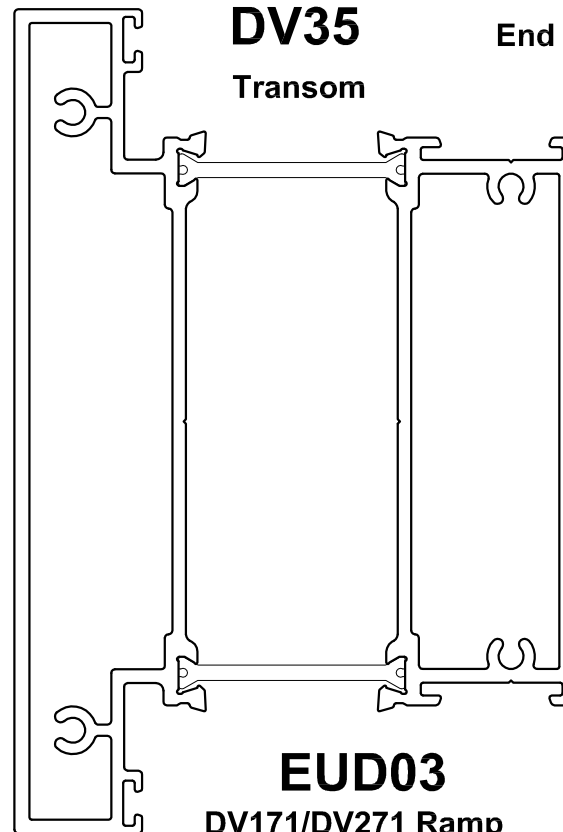

End Cap = ACDV56

DV76

End Cap = ACDV76

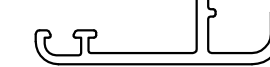

DV60
Infill Strip



DV62
Woolpile Carrier



DV68

Gasket Carrier



DV75

French Door Adaptor

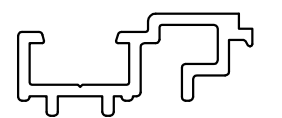

DV171

Low Threshold
Open In Only

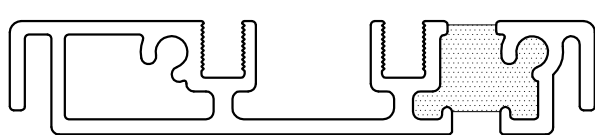

DV173

Low Threshold

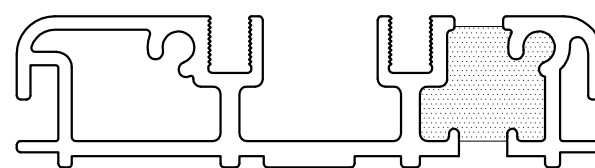

DV64
32mm
Glazing

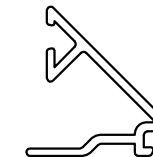

DV67
28mm
Glazing

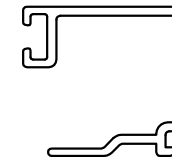

DV555
Floating Corner
Post

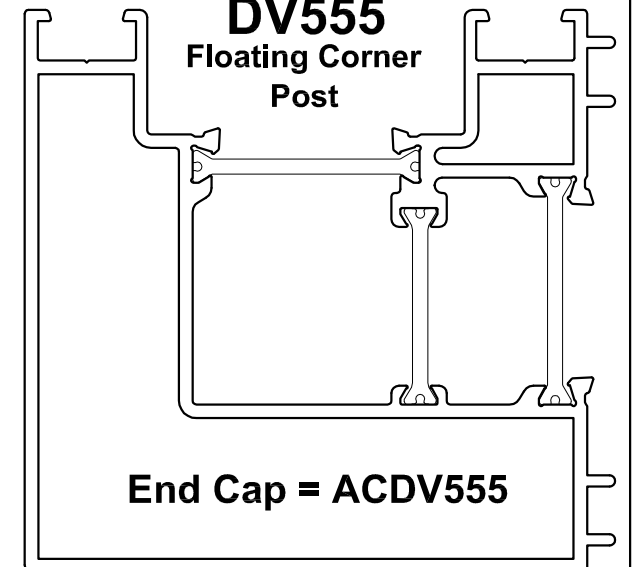

End Cap = ACDV555

DV271

Low Threshold
Open Out Only

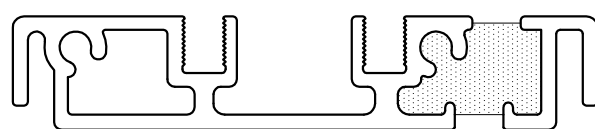

ACVS010

DV175

Low Threshold

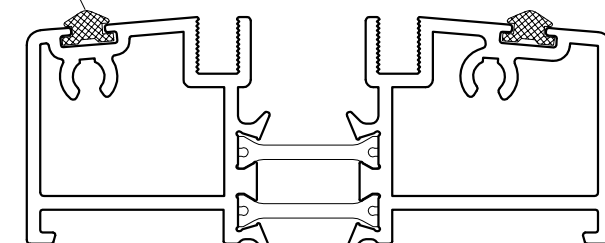

EUD03

DV171/DV271 Ramp

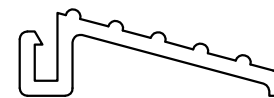

DV174

DV173 Threshold Ramp

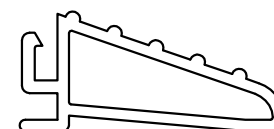

DV160
24mm
Glazing

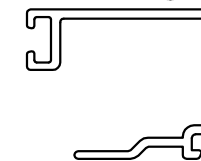

DV161
34-38mm
Glazing

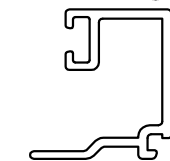

No unauthorised use, copy or disclosure of this drawing is to be made.
It is to be returned whenever required.

ISSUE	MOD No.	DATE

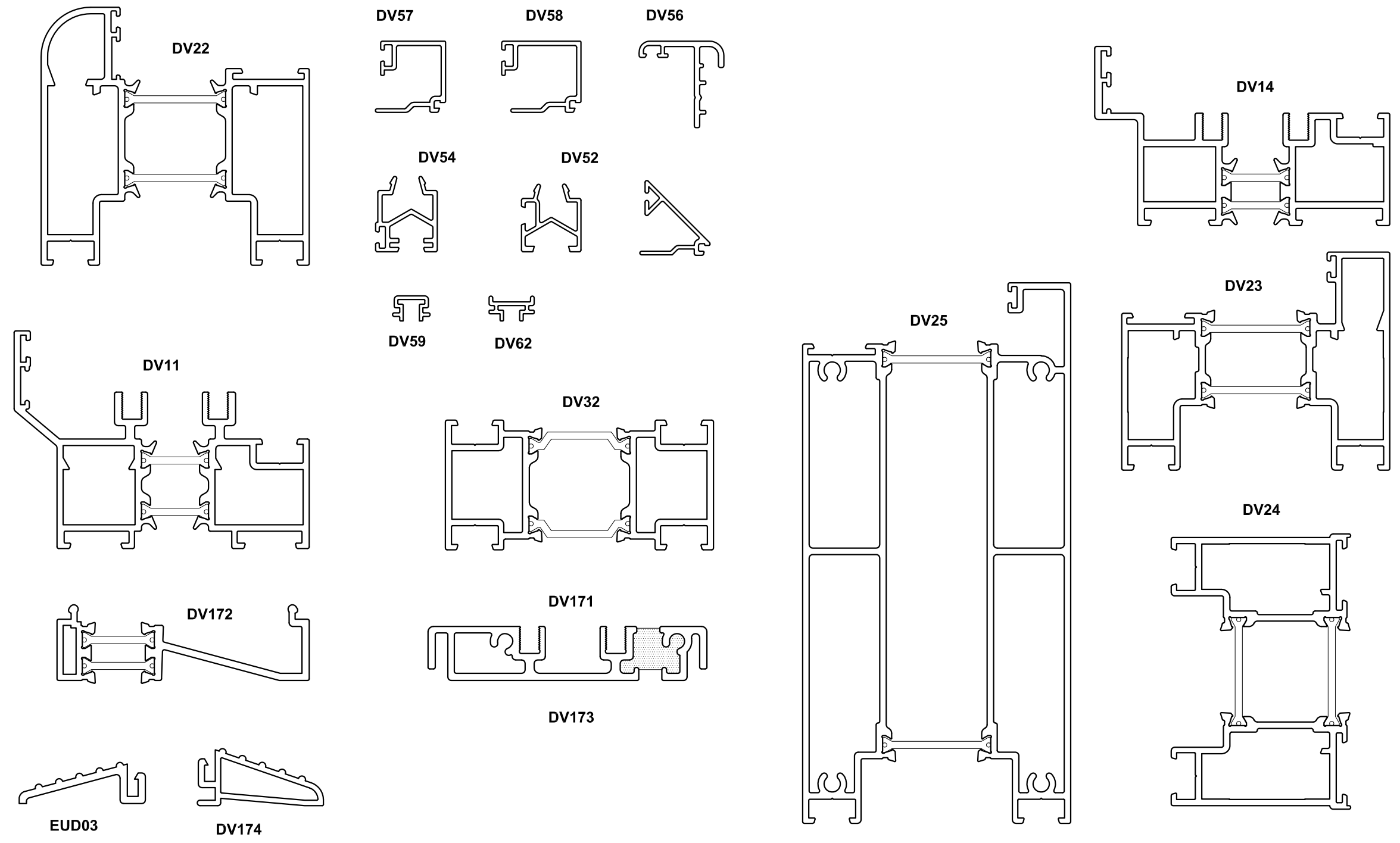

TITLE

Visofold Panorama Bi Fold - Wall Chart



Smart Systems Limited
Arnolds Way, Yatton,
North Somerset,
BS49 4QN
Tel: +44 (0)1934 876 100
Fax: +44 (0)1934 835 169
www.smartsystems.co.uk

CHECKED				
PRODUCT CODE				
MATERIAL	ISSUE	MOD No.	DESCRIPTION	DATE
	DRAWN	D.N.		DRAWING No.
	DATE	JULY_2010		
	SCALE	N.T.S.@A3		

No unauthorised use, copy or disclosure of this drawing is to be made.
It is to be returned whenever required.

ISSUE	MOD No.	DATE

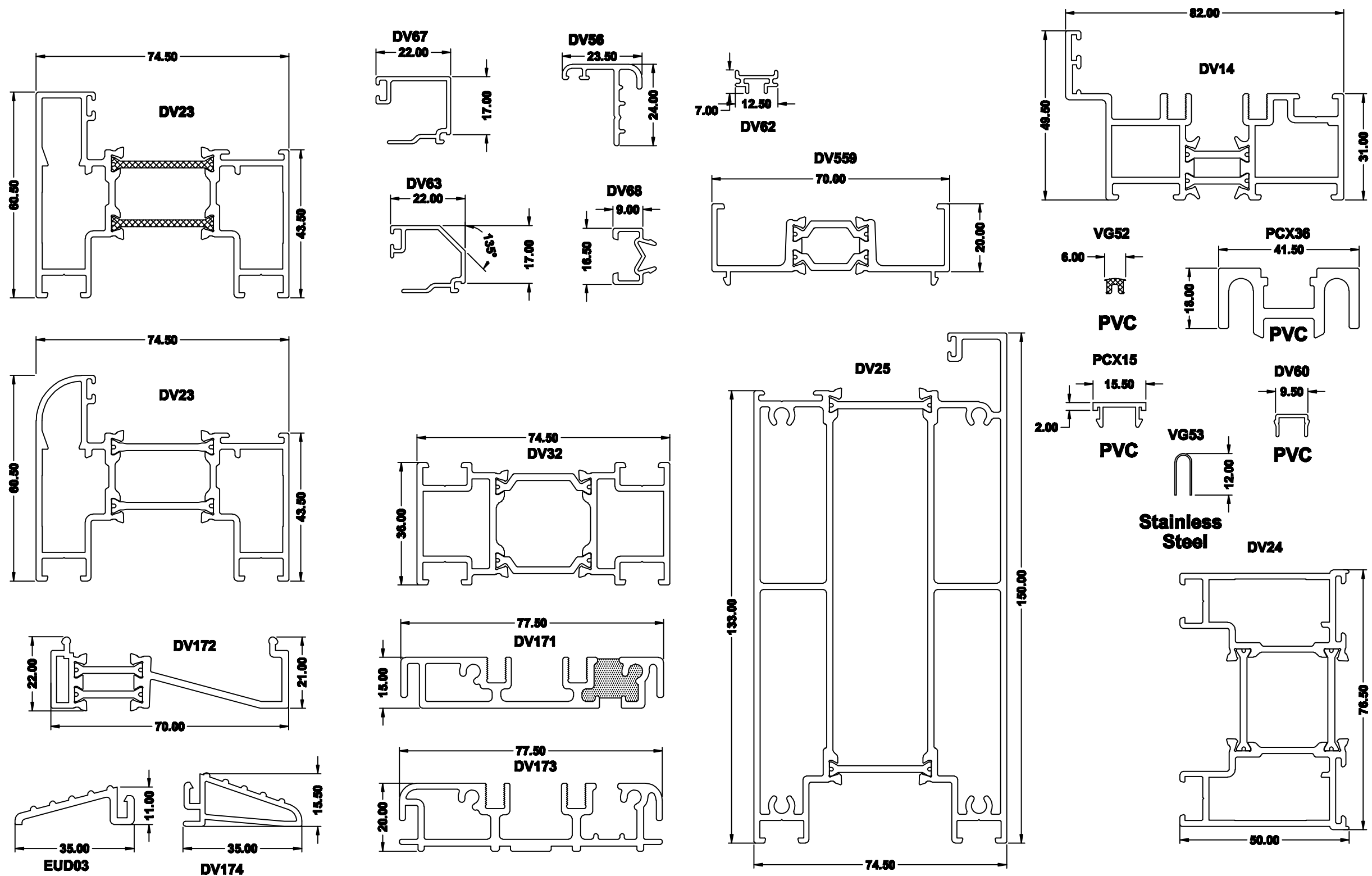

TITLE

Visofold 1000 & 2000 - Wall Chart

smart
architectural aluminium

Smart Systems Limited
Arnolds Way, Yatton,
North Somerset,
BS48 4GN
Tel: +44 (0)1234 676 100
Fax: +44 (0)1234 635 100
www.smartsystems.co.uk

CHECKED			
PRODUCT CODE			
MATERIAL			
ISSUE	MOD No.	DESCRIPTION	DATE
DRAWN	D.N.		DRAWING No.
DATE	JULY 2010		
SCALE	N.T.S. @ A3		

Copyright Smart Systems Ltd

VICTORIAN / VT

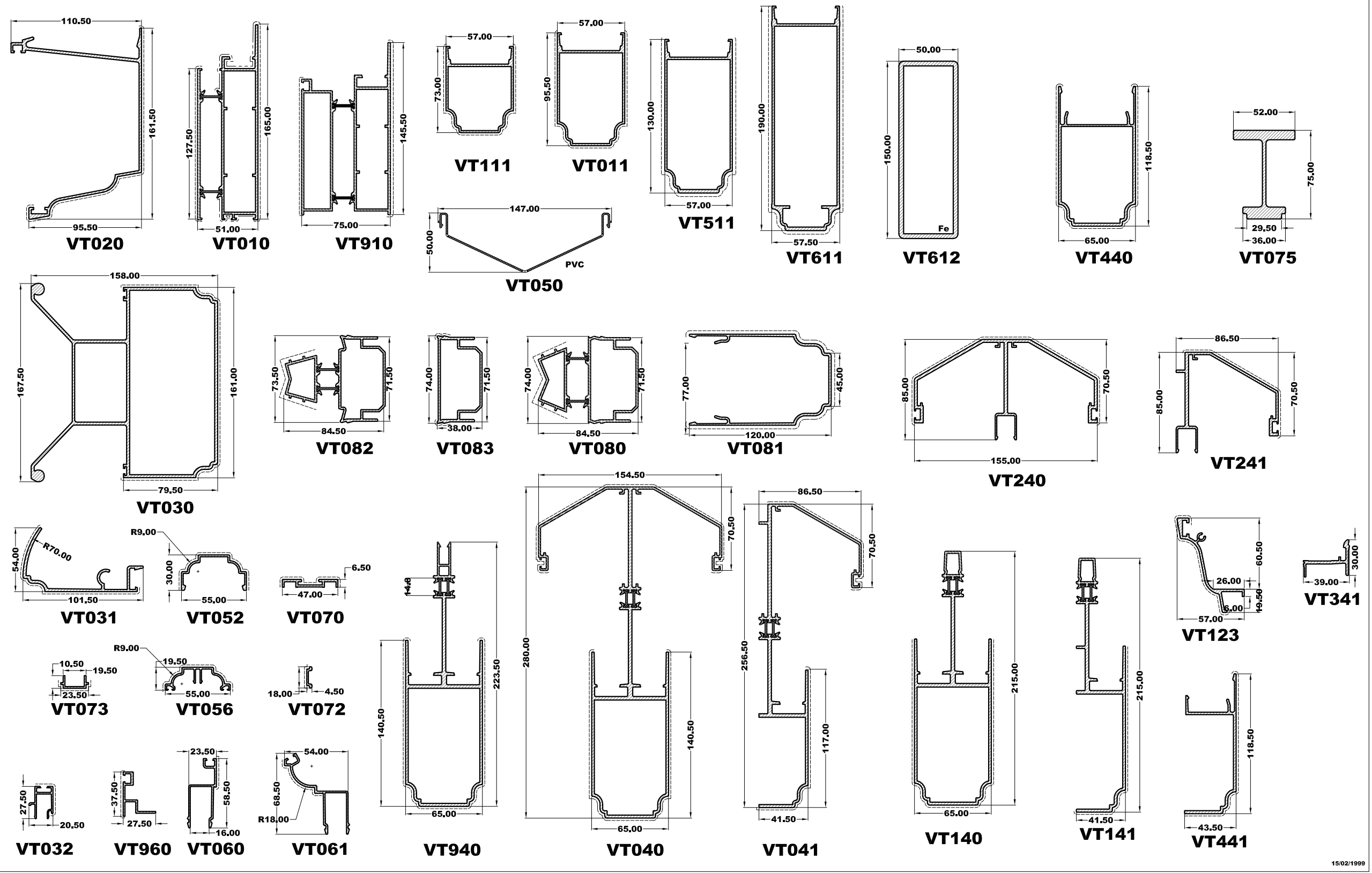

15/02/1999

TITLE

Victorian - Wall Chart



Smart Systems Limited
Arnolds Way, Yatton,
North Somerset,
BS49 4QN
Tel: +44 (0)1934 876 100
Fax: +44 (0)1934 835 169
www.smartsystems.co.uk

CHECKED			
PRODUCT CODE			
MATERIAL	ISSUE MOD No.	DESCRIPTION	DATE
	DRAWN	DRAWN	DRAWING No.
	DATE	JULY_2010	
	SCALE	N.T.S.@A3	

No unauthorised use, copy or disclosure of this drawing is to be made.
It is to be returned whenever required.

ISSUE	MOD No.	DATE

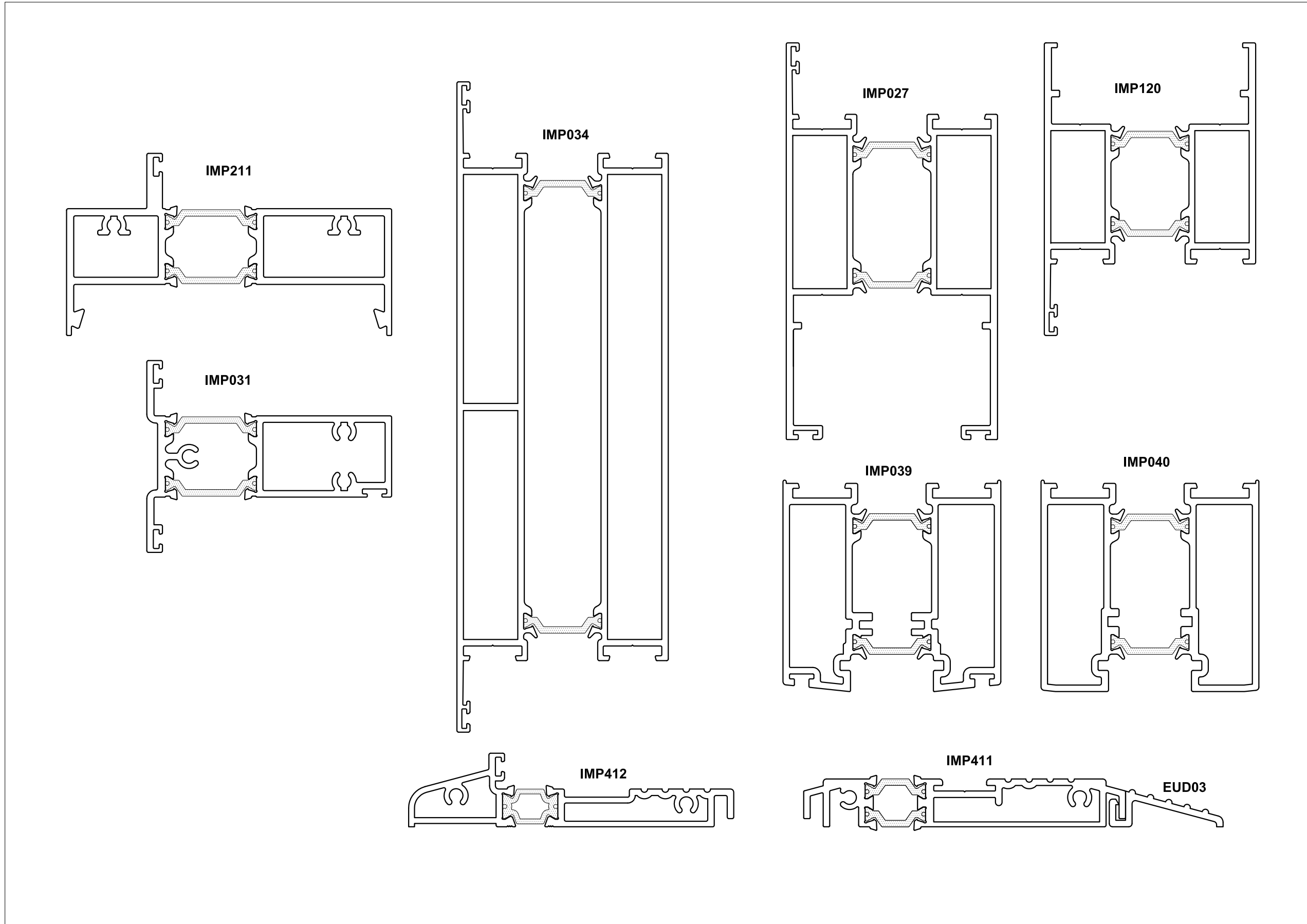

TITLE

Smart Wall - Wall Chart No.3

smart
architectural aluminium

Smart Systems Limited
Arnolds Way, Yatton,
North Somerset,
BS49 4QN
Tel: +44 (0)1934 876 100
Fax: +44 (0)1934 835 169
www.smartsystems.co.uk

CHECKED				
PRODUCT CODE				
MATERIAL	ISSUE	MOD No.	DESCRIPTION	DATE
	DRAWN	D.N.		DRAWING No.
	DATE	JULY_2010		
	SCALE	N.T.S.@A3		

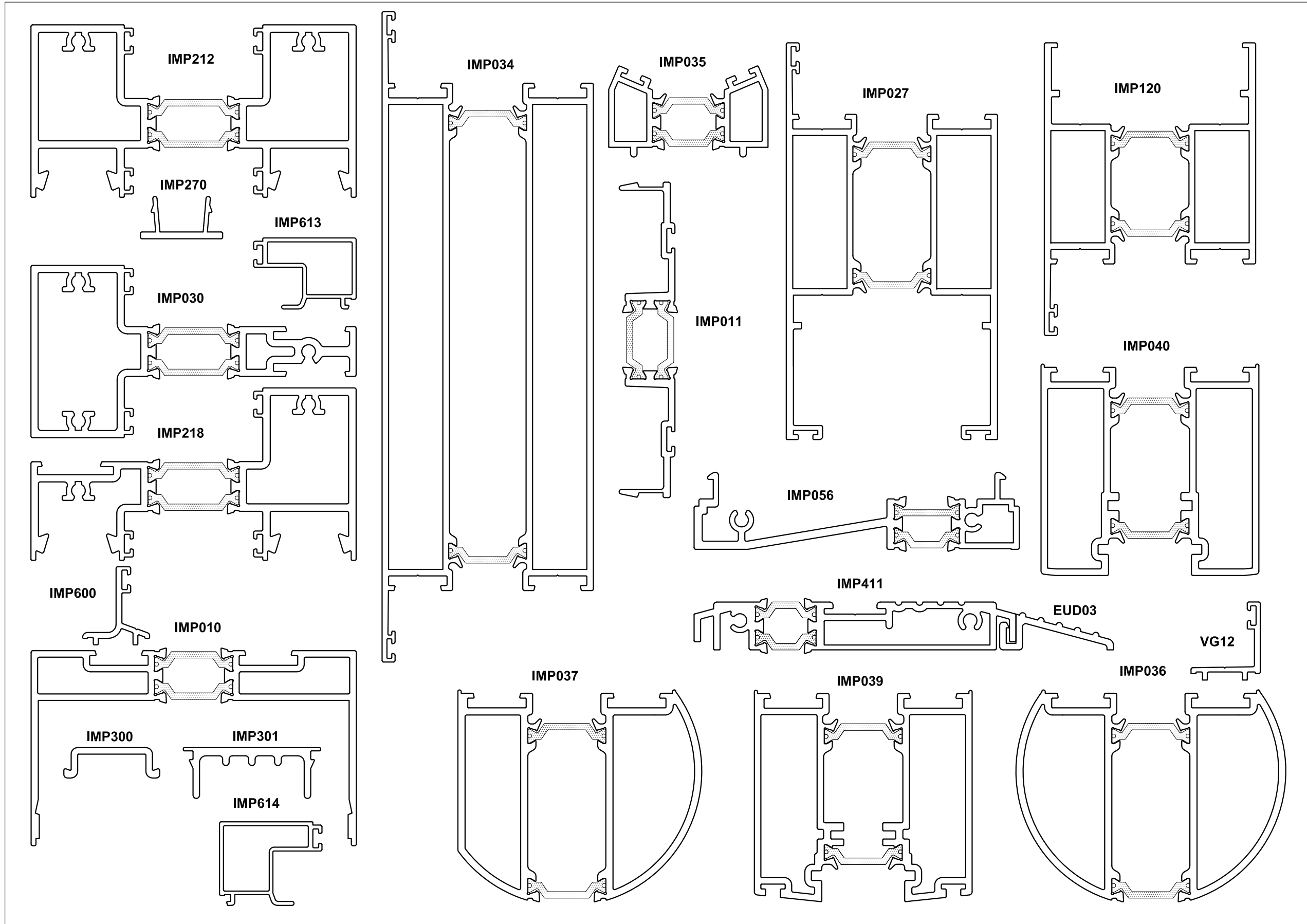

TITLE

Smart Wall - Wall Chart No.2

smart
architectural aluminium

Smart Systems Limited
Arnolds Way, Yatton,
North Somerset,
BS49 4QN
Tel: +44 (0)1934 876 100
Fax: +44 (0)1934 835 169
www.smartsystems.co.uk

CHECKED				
PRODUCT CODE				
MATERIAL	ISSUE	MOD No.	DESCRIPTION	DATE
	DRAWN	D.N.		DRAWING No.
	DATE	JULY_2010		
	SCALE	N.T.S.@A3		

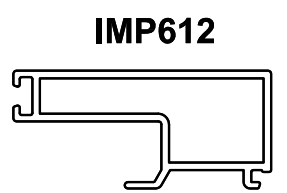
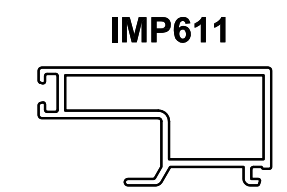
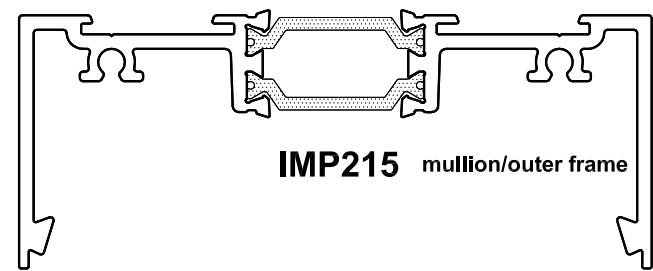
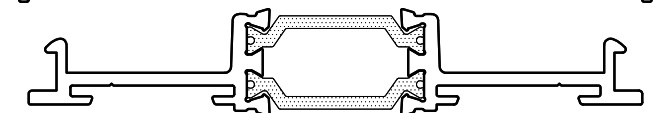
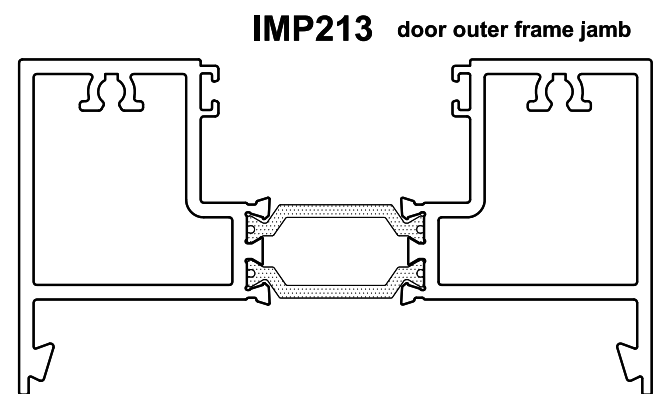
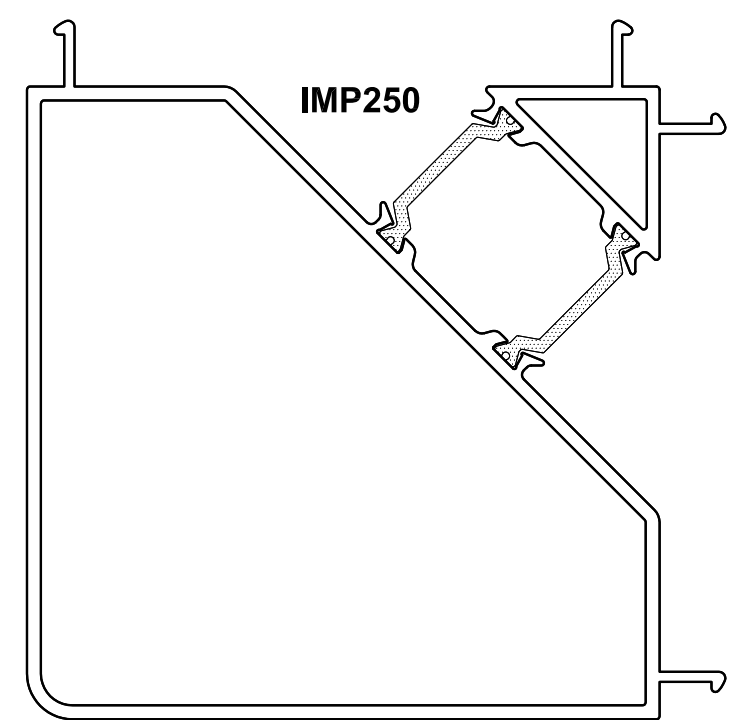
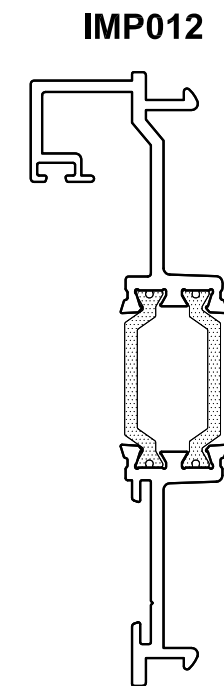
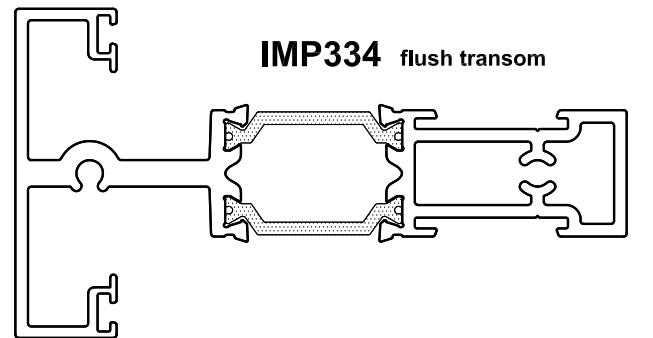
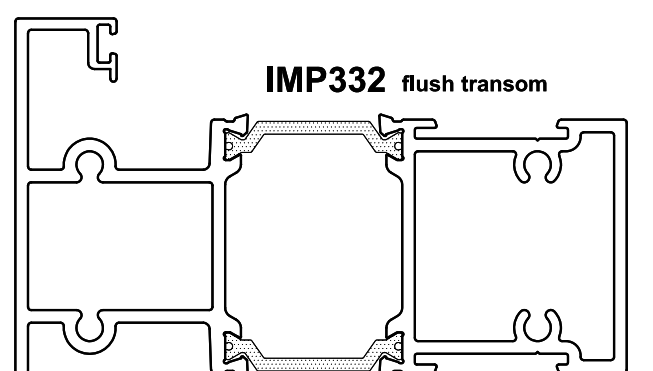
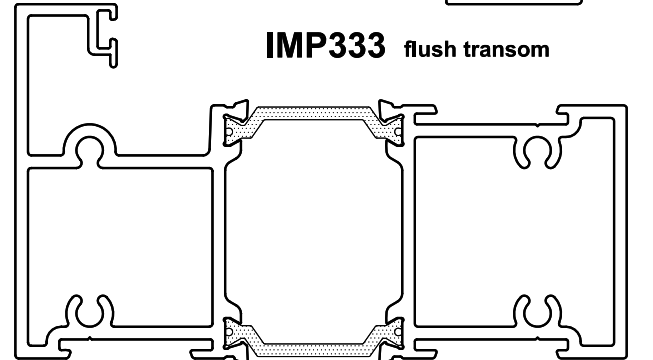
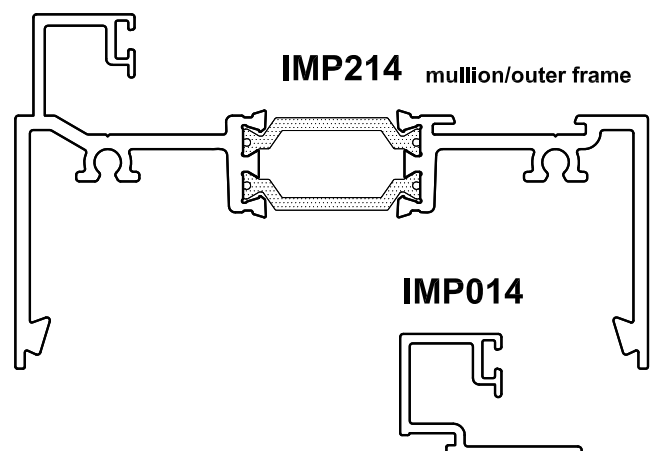
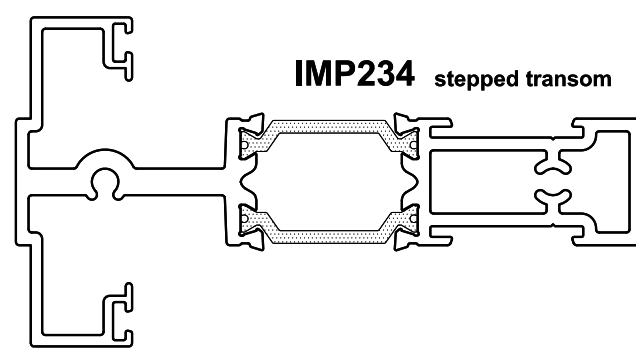
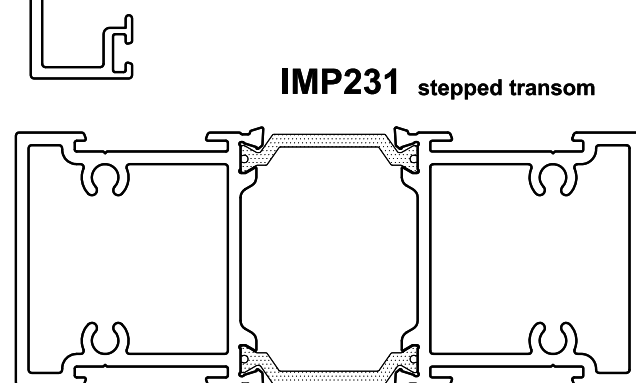
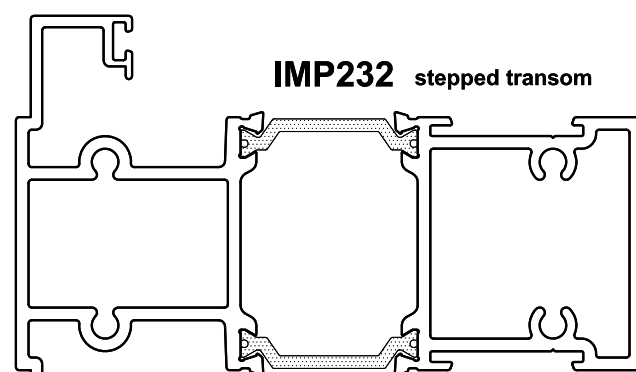
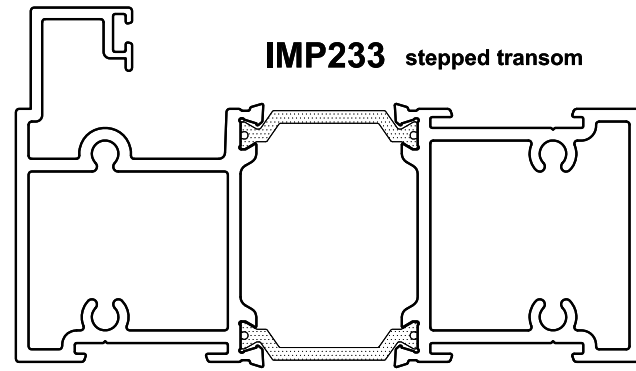

TITLE

Smart Wall - Wall Chart No.1



Smart Systems Limited
Arnolds Way, Yatton,
North Somerset,
BS49 4QN
Tel: +44 (0)1934 876 100
Fax: +44 (0)1934 835 169
www.smartsystems.co.uk

CHECKED				
PRODUCT CODE				
MATERIAL	ISSUE	MOD No.	DESCRIPTION	DATE
	DRAWN	D.N.		DRAWING No.
	DATE	JULY_2010		
	SCALE	N.T.S.@A3		

No unauthorised use, copy or disclosure of this drawing is to be made.
It is to be returned whenever required.

ISSUE	MOD No.	DATE

ESF01
18mm POCKET BOX

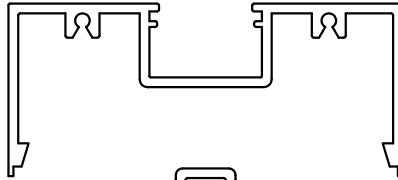

ESF04 18mm POCKET PLATE



ESF05 FLAT PLATE

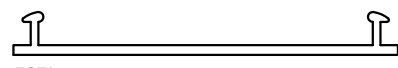

ESF43 18mm POCKET FILLER

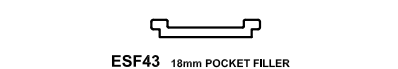

ESF02
PLAIN BOX

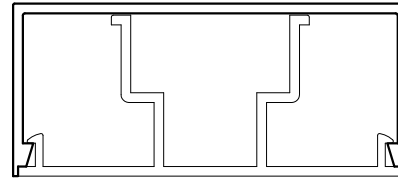

ESF87 JAMB REINFORCER



ESF04 18mm POCKET PLATE



ESF05 FLAT PLATE

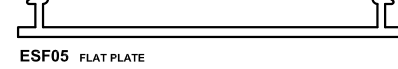

ESF84 24mm POCKET PLATE



ESF105 BEAD PLATE



ESF44 GLAZING ADAPTOR



ESF03
18mm CILL/TRANSOM BOX

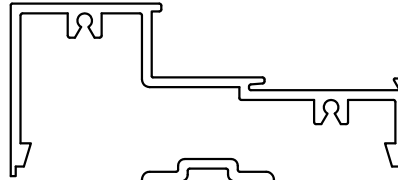

ESF04 18mm POCKET PLATE



ESF85 DRAINAGE CILL



ESF21 18mm BEAD FOR ESF03



ESF86
24mm POCKET CORNER POST

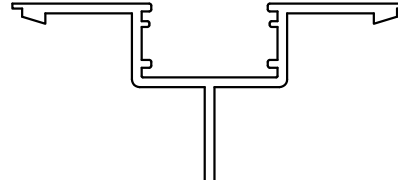

ESF05 FLAT PLATE

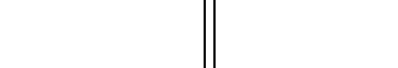

ESF84 24mm POCKET PLATE

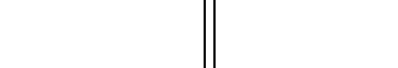

ESF11
50mm DOOR STILE

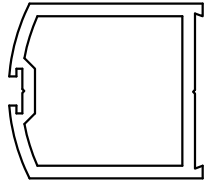

ESF99
50mm TWIN WOOLPILE DOOR STILE

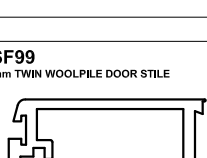

LOCK FIXING PLATES
CFA033MFZ

ESF94
88mm DOOR STILE

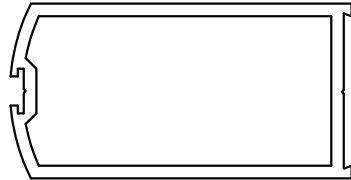

ESF104
88mm TWIN WOOLPILE DOOR STILE

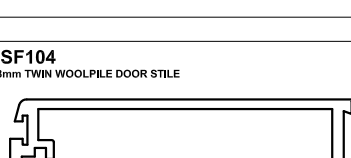

LOCK FIXING PLATES
CFA033MFZ

ESF12
DOOR LEAF TOP RAIL

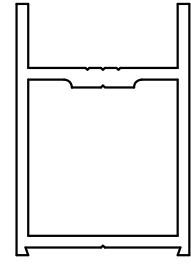

ESF83
24mm POCKET BOX

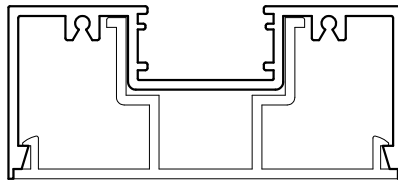

ESF87 JAMB REINFORCER



ESF04 18mm POCKET PLATE



ESF84 24mm POCKET PLATE

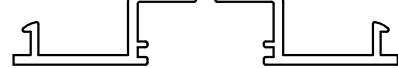

ESF105 BEAD PLATE

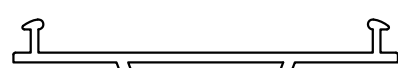

ESF93 24mm POCKET FILLER

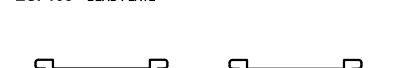

ESF91 HINGED DOOR REBATE



ESF106 24mm POCKET FILLER



CFA039SAZ
HOOK BOLT KEEP
(NOT TO SCALE)

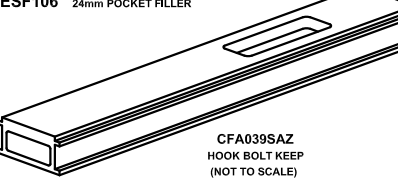

ESF06/ESF07
18mm POCKET CORNER POST

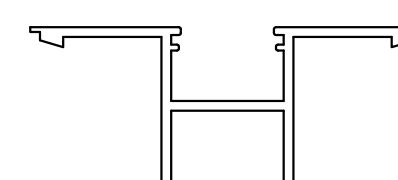

ESF04 18mm POCKET PLATE



ESF05 FLAT PLATE

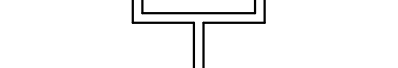

ESF89
24mm CILL/TRANSOM BOX

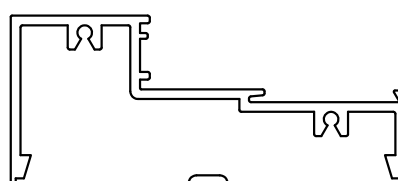

ESF84 24mm POCKET PLATE



ESF85 DRAINAGE CILL



ESF90 24mm BEAD FOR ESF89



ESF100 ANTI-TRAP JAMB ADAPTOR

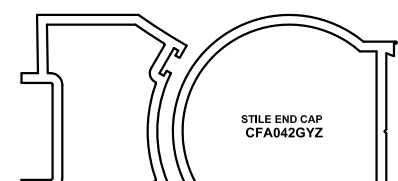

ESF98 ANTI-TRAP DOOR STILE



STILE END CAP
CFA042GYZ

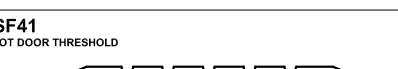

ESF41 PIVOT DOOR THRESHOLD

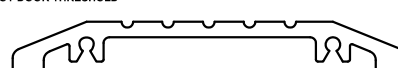

ESF95 HINGE DOOR THRESHOLD



ESF92
PLAIN BOX (WITH SCREWPORTS)

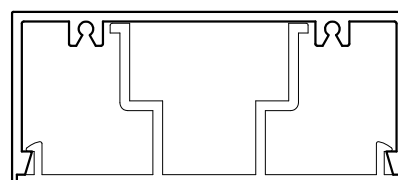

ESF87 JAMB REINFORCER



ESF101
50mm DOUBLE DOOR KEEP STILE

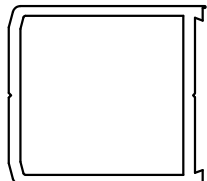

ESF103
88mm DOUBLE DOOR KEEP STILE

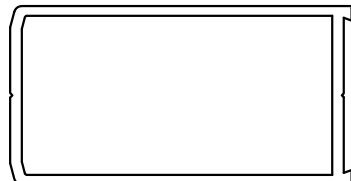

ESF47
DOOR LEAF MIDDLE RAIL

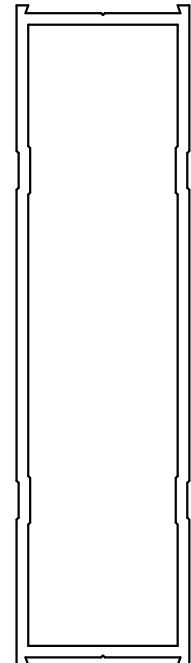

BEADS

ESF23/ESF24
SINGLE GLAZING BEADS



ESF25/ESF26
6-18mm GLAZING BEADS



ESF27/ESF28
24mm GLAZING BEADS



ESF108
50mm REBATED DOUBLE DOOR MEETING STILE

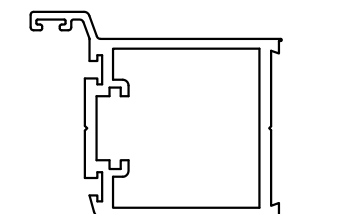

ESF88
MUNTIN BAR

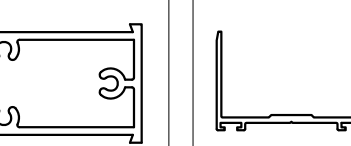

ESF107
TWIN WOOLPILE INSERT FOR ESF13



ESF13
DOOR LEAF BOTTOM RAIL

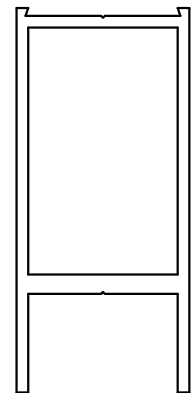

ESF46
CILL FLASHING

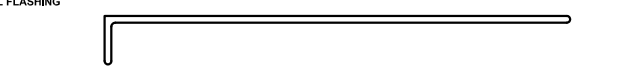

ISSUE DATE MARCH 1997

TITLE
**Shopfront Glazing System
Smart Screen - Wall Chart**



Smart Systems Limited
Arnolds Way, Yatton,
North Somerset,
BS49 4QN
Tel: +44 (0)1934 876 100
Fax: +44 (0)1934 835 169
www.smartsystems.co.uk

CHECKED				
PRODUCT CODE				
MATERIAL	ISSUE	MOD No.	DESCRIPTION	DATE
	DRAWN	DRAWN		DRAWING No.
	DATE	JULY_2010		
SCALE		N.T.S.@A3		

No unauthorised use, copy or disclosure of this drawing is to be made.
It is to be returned whenever required.

ISSUE	MOD No.	DATE

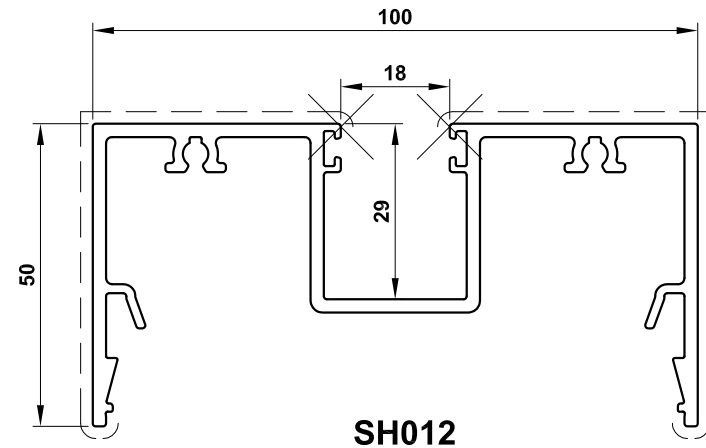

SH012

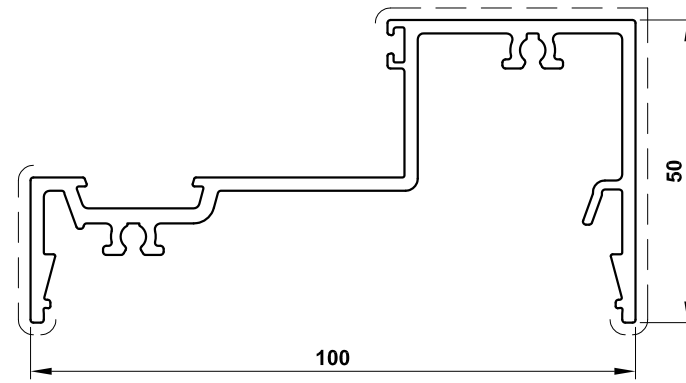

SH018

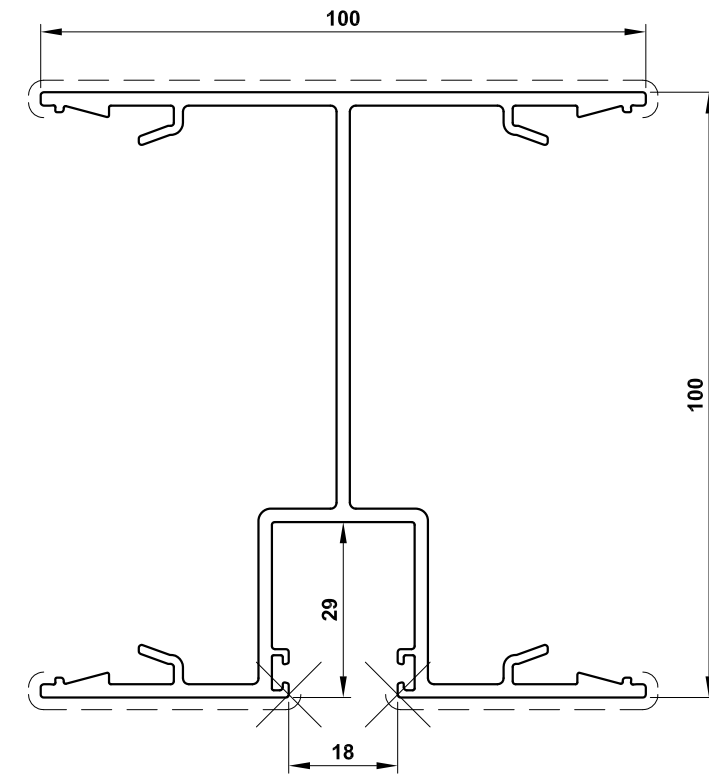

SH050

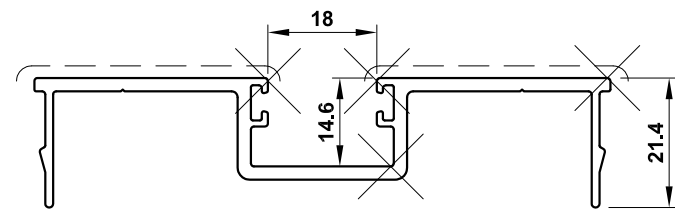

SH014

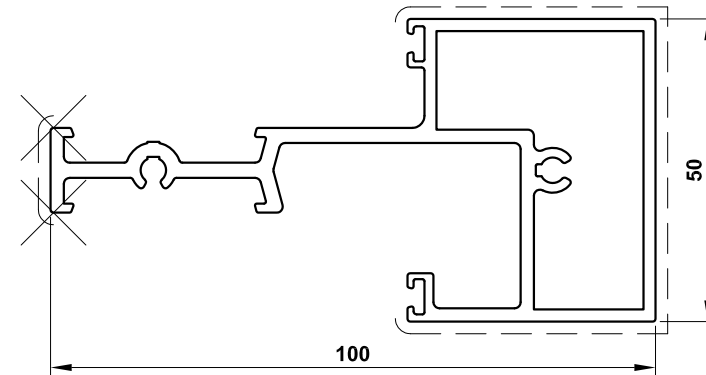

SH030

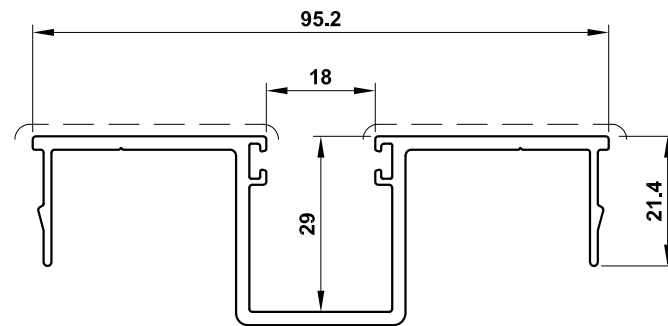

SH016

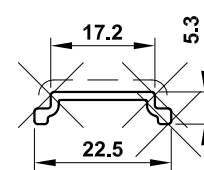

SH070

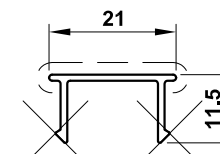

SH071

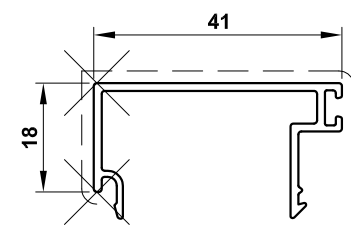

SH060

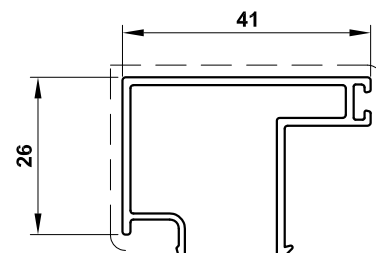

SH061

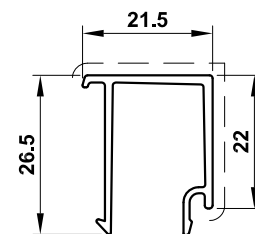

SH630

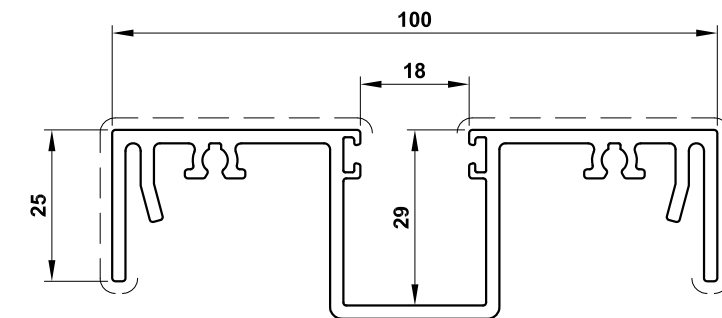

SH151

TITLE

Shopline Single Glaze - Wall Chart

smart
architectural aluminium

Smart Systems Limited
Arnolds Way, Yatton,
North Somerset,
BS49 4QN
Tel: +44 (0)1934 876 100
Fax: +44 (0)1934 835 169
www.smartsystems.co.uk

CHECKED			
PRODUCT CODE			
MATERIAL			
	ISSUE	MOD No.	DESCRIPTION
	DRAWN	D.N.	DRAWING No.
	DATE	JULY_2010	
	SCALE	N.T.S.@A3	

No unauthorised use, copy or disclosure of this drawing is to be made.
It is to be returned whenever required.

ISSUE	MOD No.	DATE

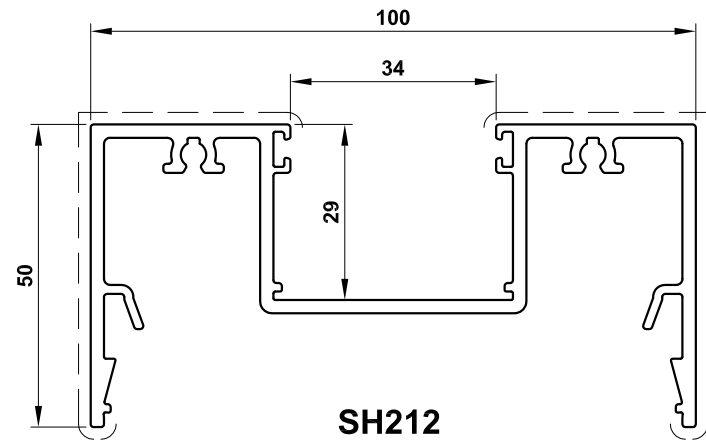

SH212

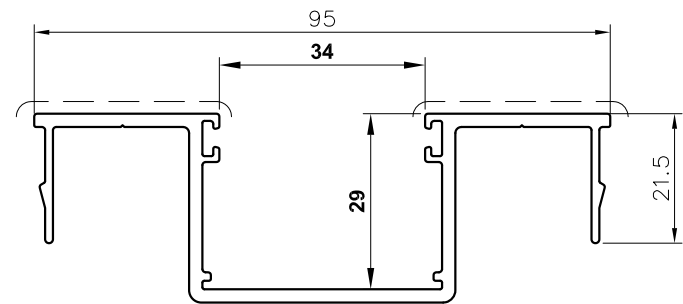

SH216

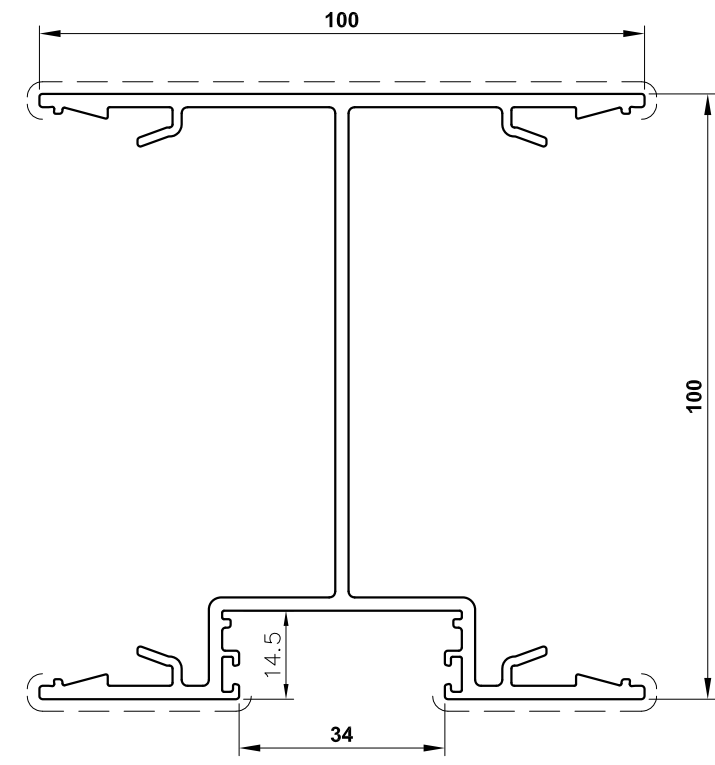

SH250

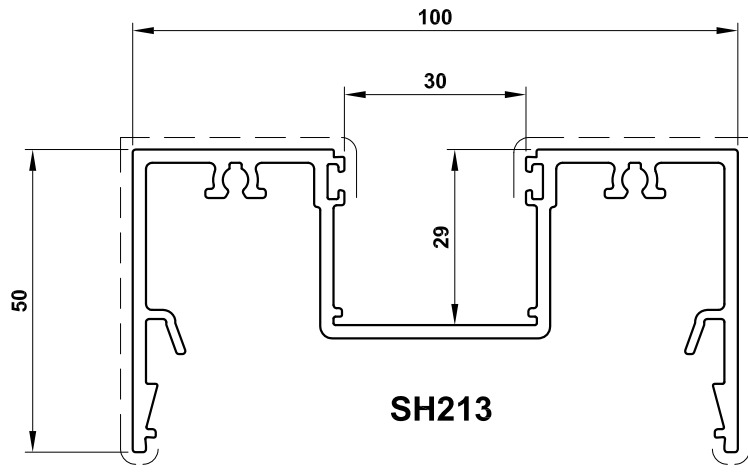

SH213

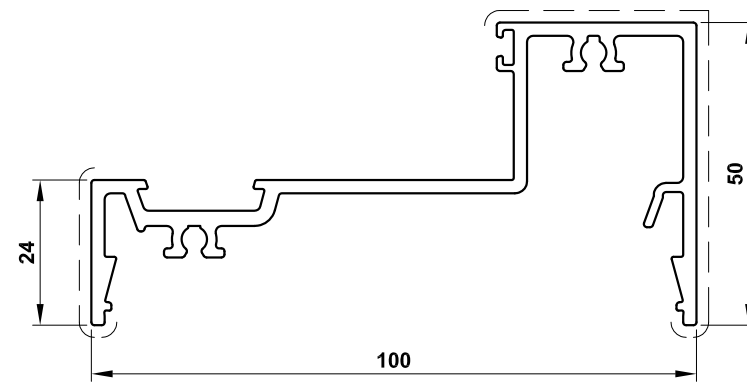

SH218

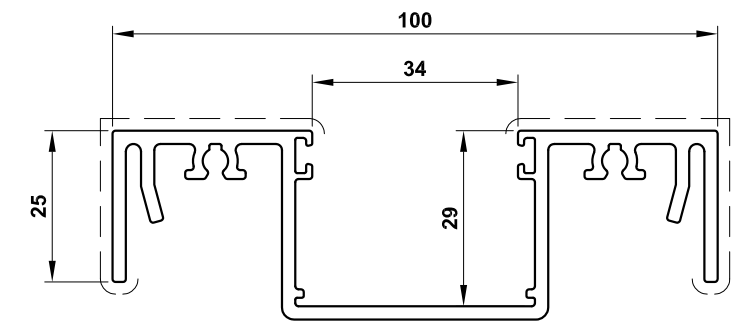

SH251

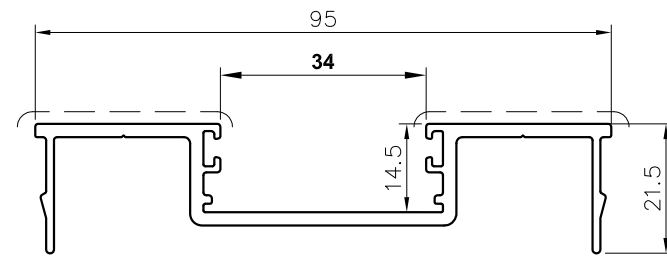

SH214

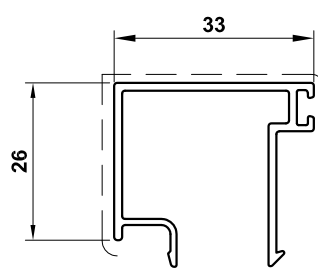

SH261

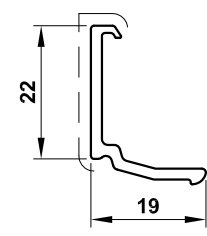

SH610

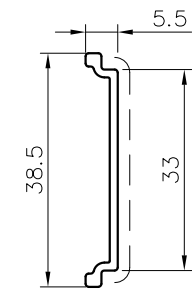

SH270

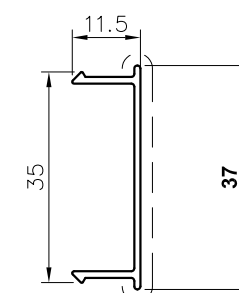

SH271

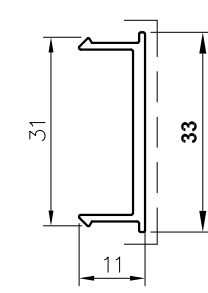

SH272

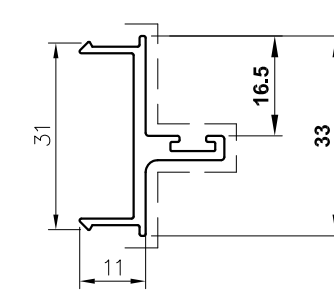

SH273

TITLE

Shopline Double Glaze - Wall Chart



Smart Systems Limited
Arnolds Way, Yatton,
North Somerset,
BS49 4QN
Tel: +44 (0)1934 876 100
Fax: +44 (0)1934 835 169
www.smartsystems.co.uk

CHECKED				
PRODUCT CODE				
MATERIAL	ISSUE	MOD No.	DESCRIPTION	DATE
	DRAWN	D.N.		DRAWING No.
	DATE	JULY_2010		
	SCALE	N.T.S.@A3		

No unauthorised use, copy or disclosure of this drawing is to be made.
It is to be returned whenever required.

ISSUE	MOD No.	DATE

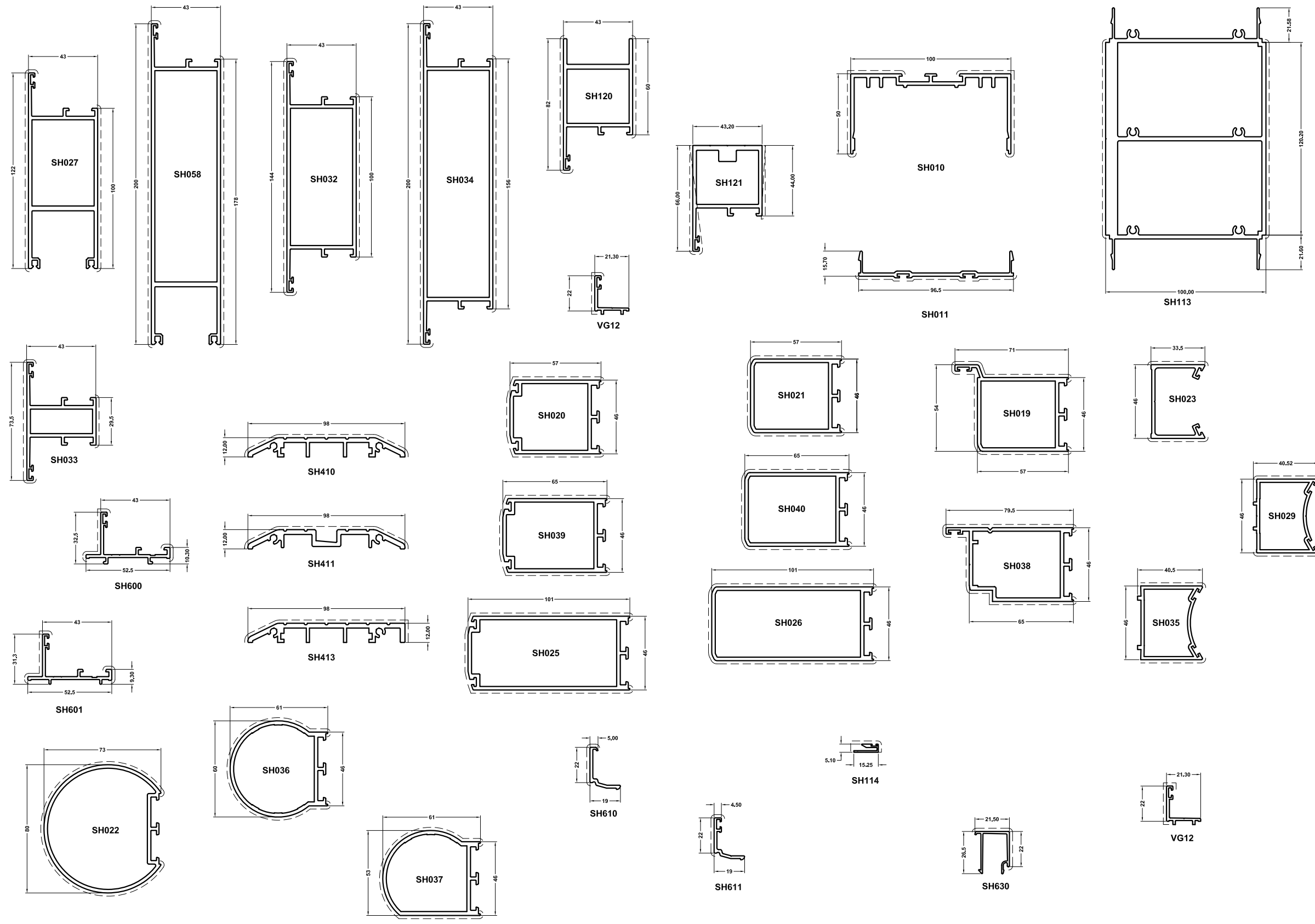

TITLE

Shopline Door - Wall Chart



Smart Systems Limited
Arnolds Way, Yatton,
North Somerset,
BS49 4QN
Tel: +44 (0)1934 876 100
Fax: +44 (0)1934 835 169
www.smartsystems.co.uk

CHECKED			
PRODUCT CODE			
MATERIAL			
	ISSUE	MOD No.	DESCRIPTION
	DATE	JULY 2010	
	SCALE	N.T.S.@A3	
			DRAWING No.

No unauthorised use, copy or disclosure of this drawing is to be made.
It is to be returned whenever required.

ISSUE	MOD No.	DATE

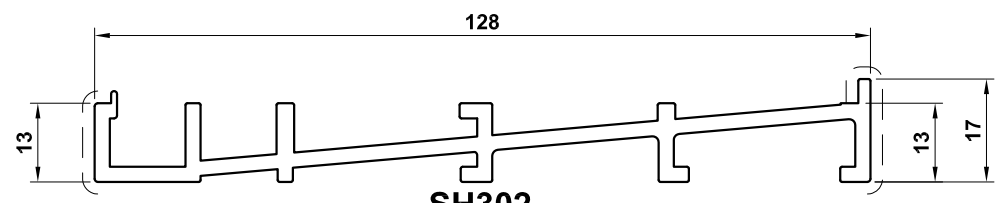
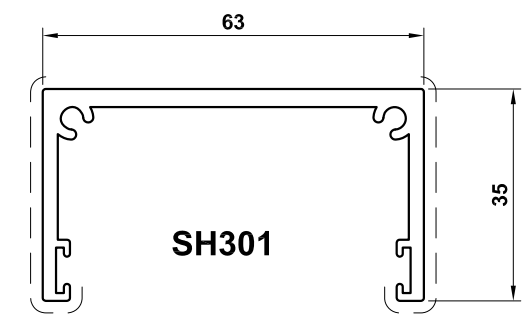
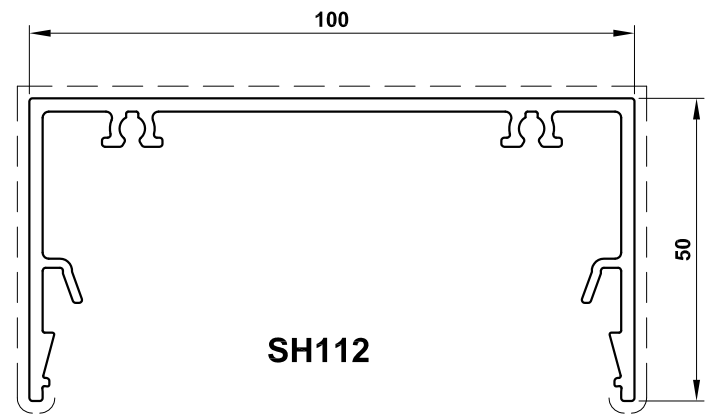
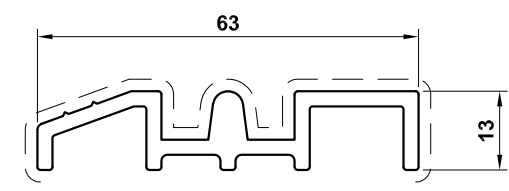
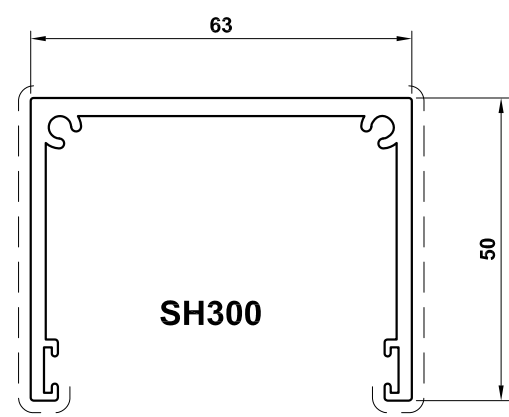
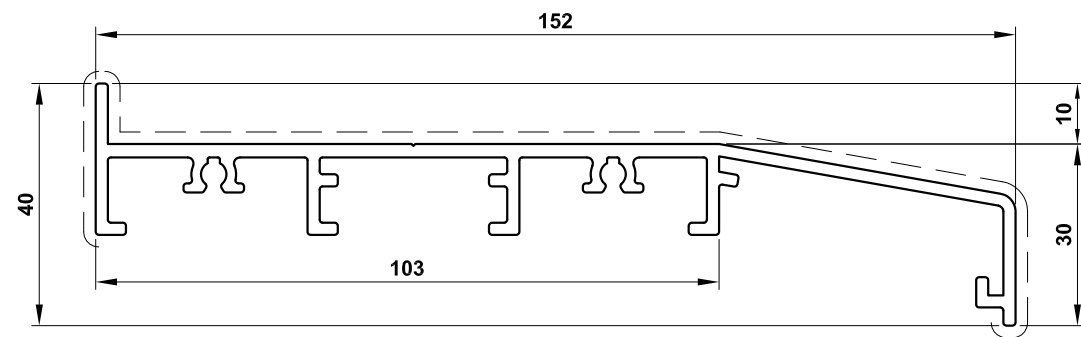
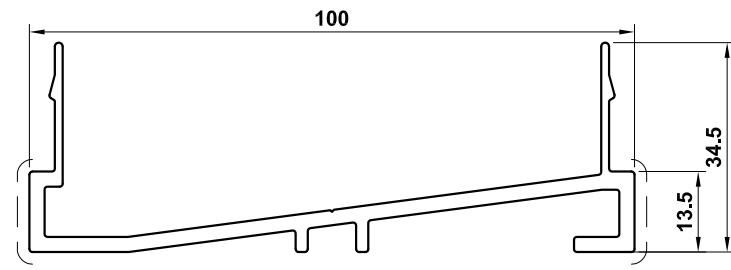
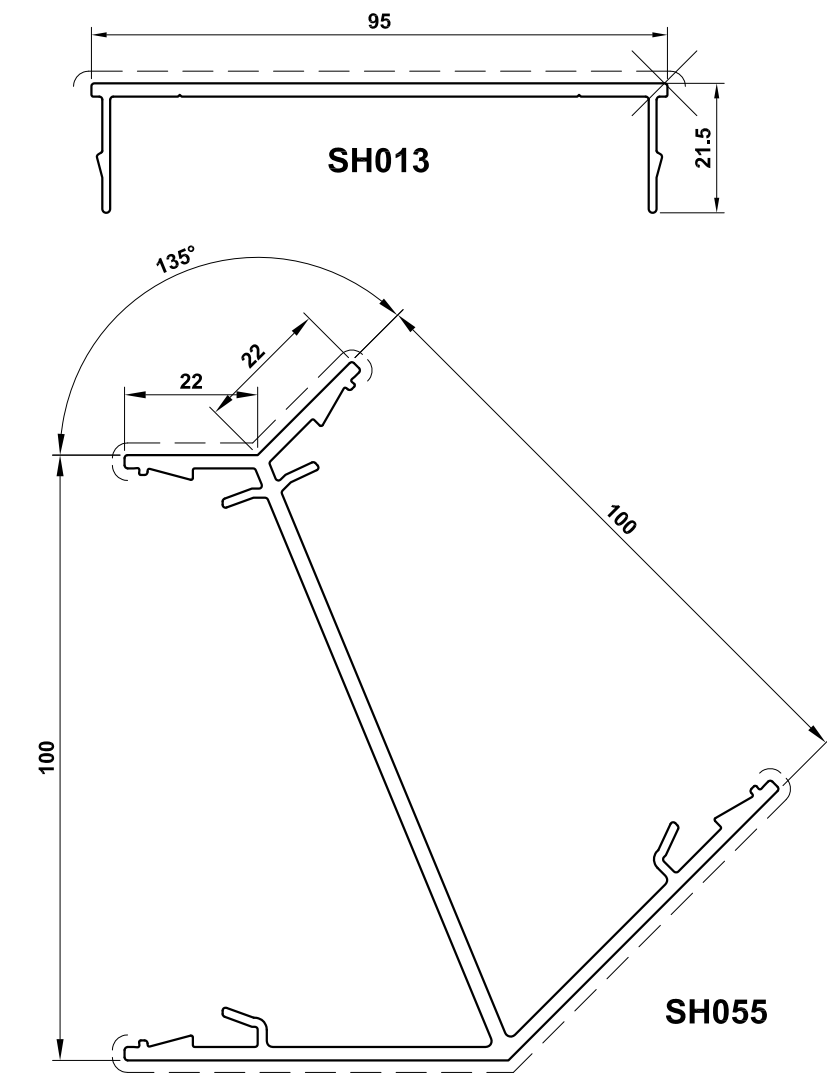

TITLE

Shopline Double & Single Glaze - Wall Chart

smart
architectural aluminium

Smart Systems Limited
Arnolds Way, Yatton,
North Somerset,
BS49 4QN
Tel: +44 (0)1934 876 100
Fax: +44 (0)1934 835 169
www.smartsystems.co.uk

CHECKED				
PRODUCT CODE				
MATERIAL	ISSUE	MOD No.	DESCRIPTION	DATE
	DRAWN	D.N.		DRAWING No.
	DATE	JULY_2010		
	SCALE	N.T.S.@A3		

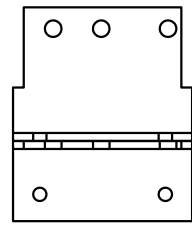

ACSC004
- Mullion Bracket
To MC070

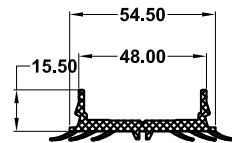

DK154

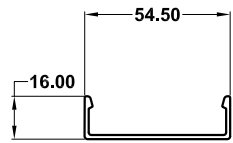

DK052

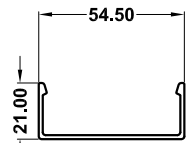

DK053

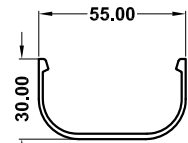

MC050

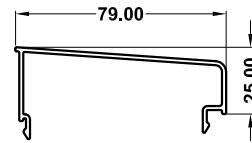

MC076

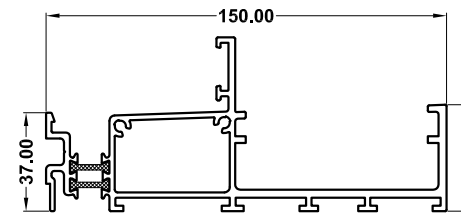

MC070



ACMC017
- 32mm Glazing
- 13.8mm Glazing
- 12mm Glazing



ACSC208
- 28mm Glazing
- 10.8mm Glazing
- 10mm Glazing



ACSC212
- 24mm Glazing
- 6.4mm Glazing
- 6mm Glazing



ACSC001
- Isolator

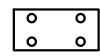

ACSC110
- Cleat Back Plate

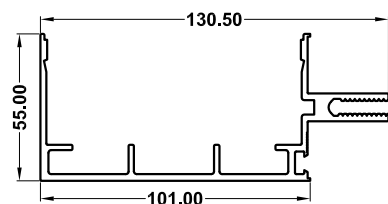

SC010

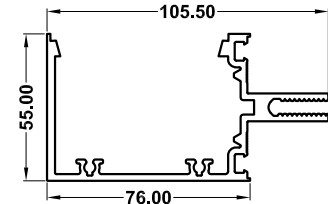

SC013

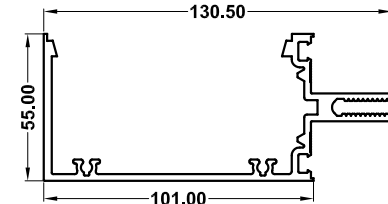

SC014

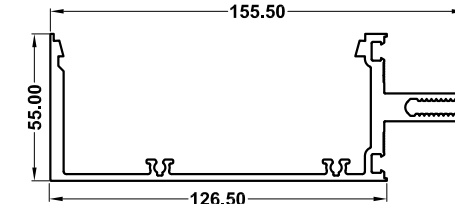

SC016

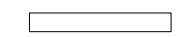

ACSC002
- Transom End Pad



ACSC003
- Transom End Block

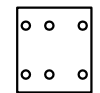

ACSC111
- Cleat Back Plate

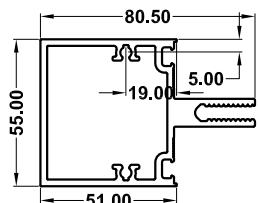

SC030

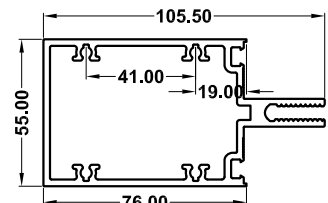

SC031

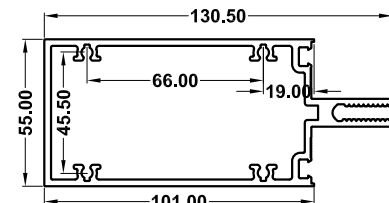

SC032

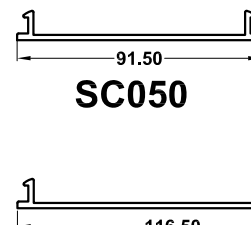

SC050

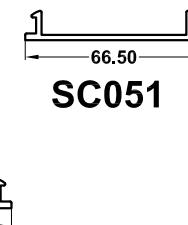

SC051

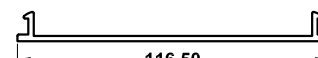

SC052

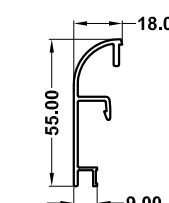

SC053



ACMC109
- Screw 6.3 x 38

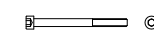

HEA028SSZ
- M6 x 70mm St. St Socket Cap
Screw



ACSC070
- Transom Cleat

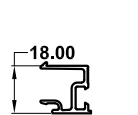

SC060

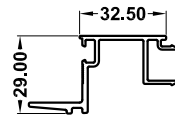

SC061

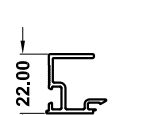

SC062

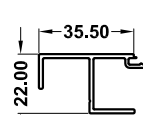

SH063

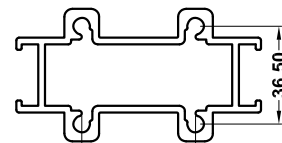

SC070

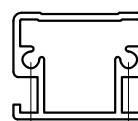

SC071

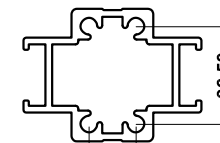

SC072



SH011



WCA137SSZ
- M6 Nut



ACSC071
- Transom Cleat

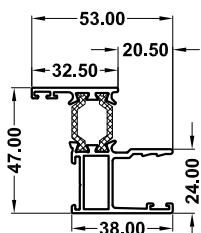

ETC014

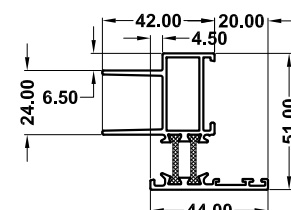

IN017

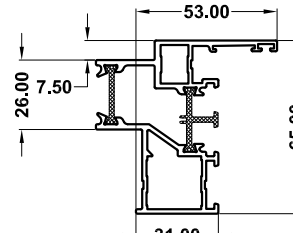

IP017

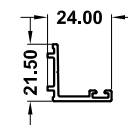

VG12

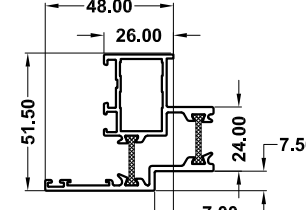

VL17



ACDK066

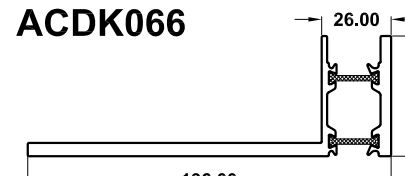

MC080



ACSC005
- Anti-Shake Washer



MUA65SSZ
- No.10 x 12mm Pan HD



ACSC072
- Transom Cleat



ACMC026
- Pin For ACSC004 Bracket

TITLE

SC Frame - Wall Chart



Smart Systems Limited
Arnolds Way, Yatton,
North Somerset,
BS49 4QN
Tel: +44 (0)1934 876 100
Fax: +44 (0)1934 835 169
www.smartsystems.co.uk

CHECKED				
PRODUCT CODE				
MATERIAL	ISSUE	MOD No.	DESCRIPTION	DATE
	DRAWN	D.N.	DRAWING No.	
	DATE	JULY_2010		
	SCALE	N.T.S.@A3		

RV010
50MM OUTER FRAME

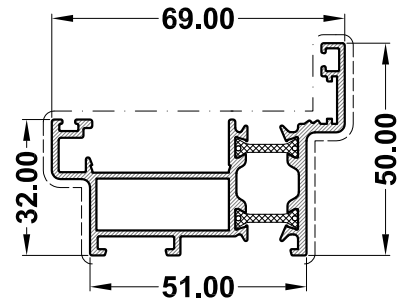

RV021
SASH

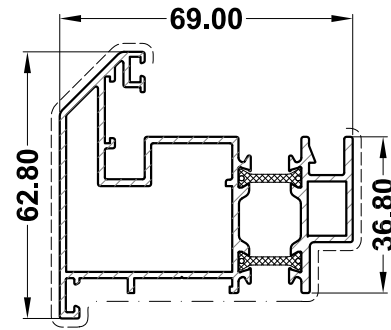

BEADS

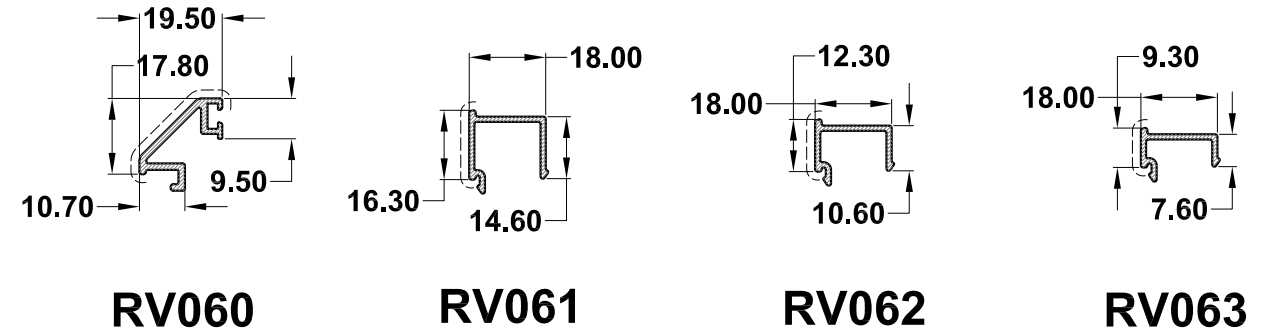

RV030
76MM TRANSOM

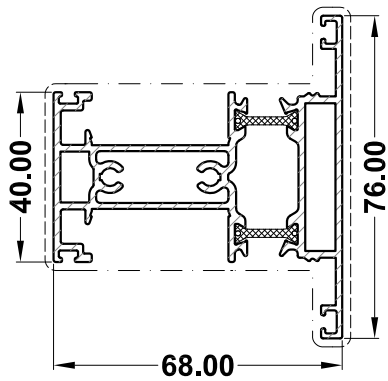

RV045
DUMMY SASH

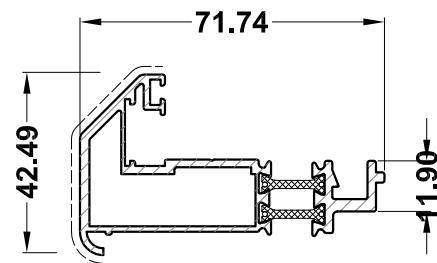

RV070
COVER PROFILE FOR RV010-RV030

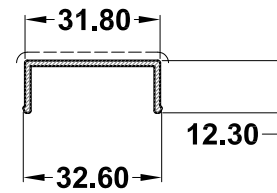

RV071
SUPPORT FOR LOCK

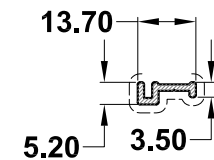

March 2002

TITLE

Reversible - Wall Chart



Smart Systems Limited
Arnolds Way, Yatton,
North Somerset,
BS49 4QN
Tel: +44 (0)1934 876 100
Fax: +44 (0)1934 835 169
www.smartsystems.co.uk

CHECKED				
PRODUCT CODE				
MATERIAL	ISSUE	MOD No.	DESCRIPTION	DATE
	DRAWN	DRAWN		DRAWING No.
	DATE	JULY_2010		
	SCALE	N.T.S.@A3		

PL STANDARDS / UTL

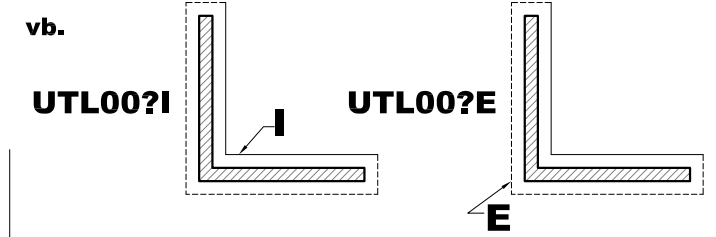
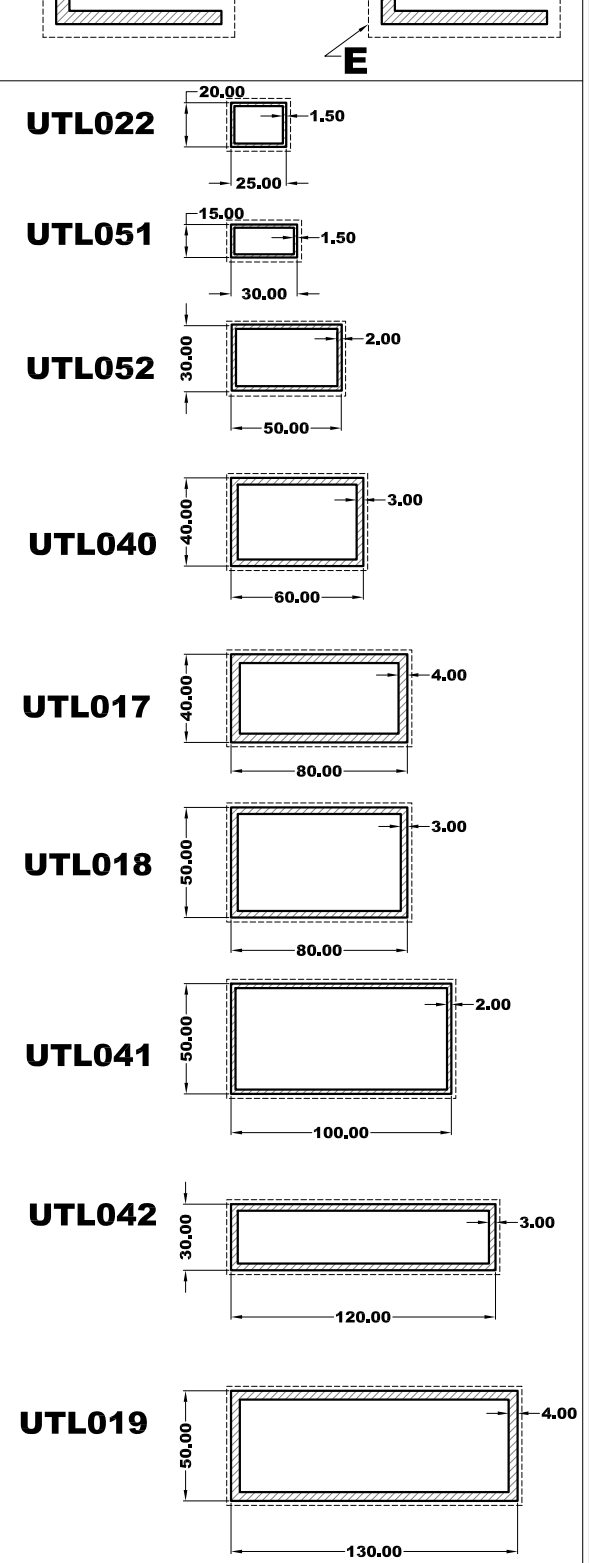
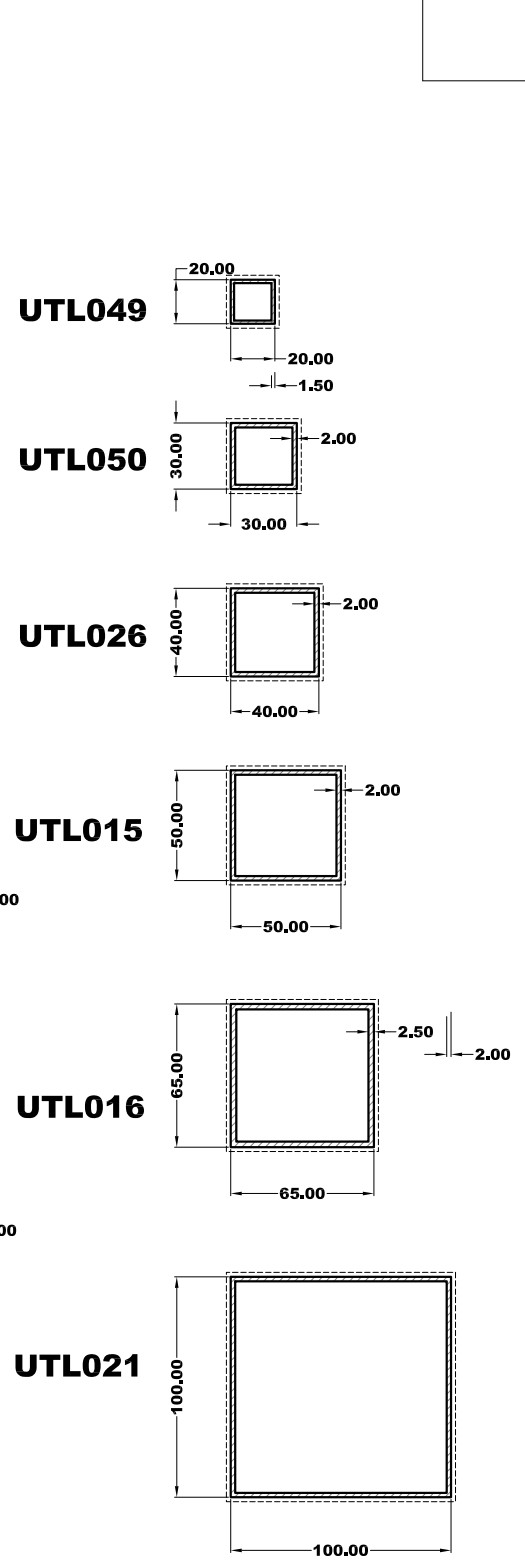
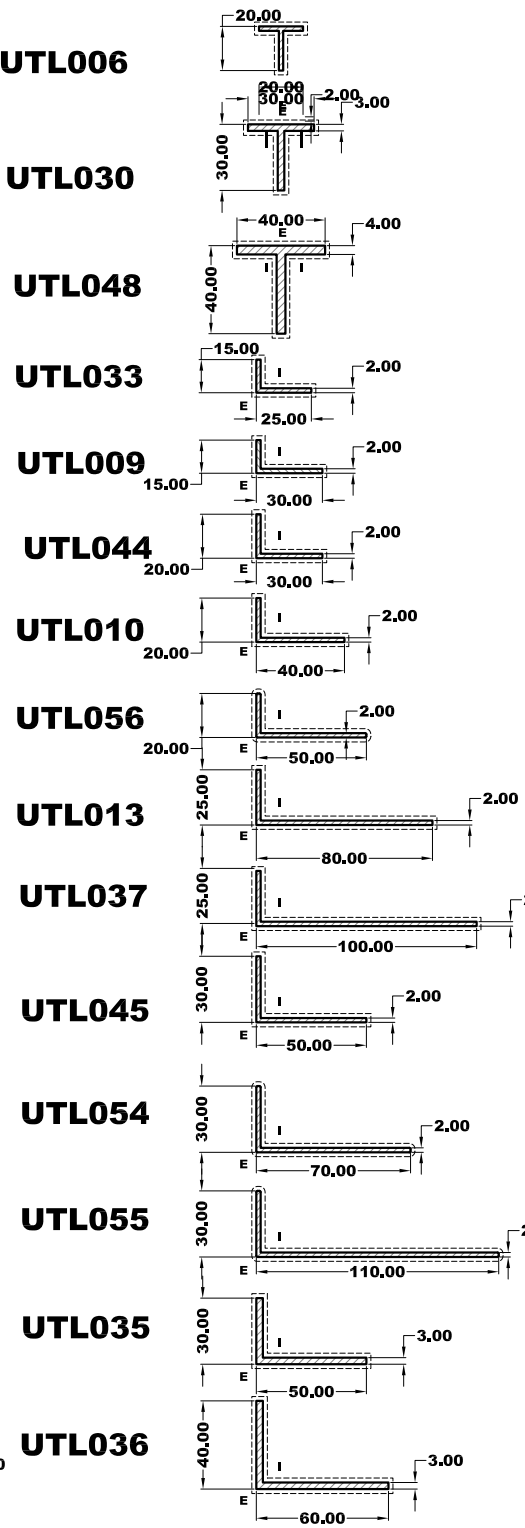
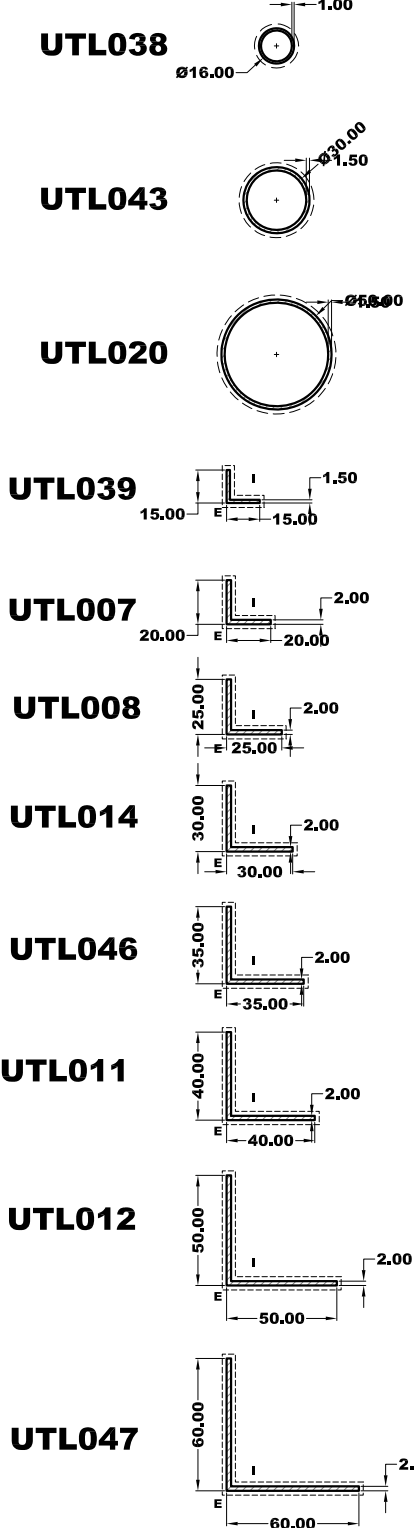
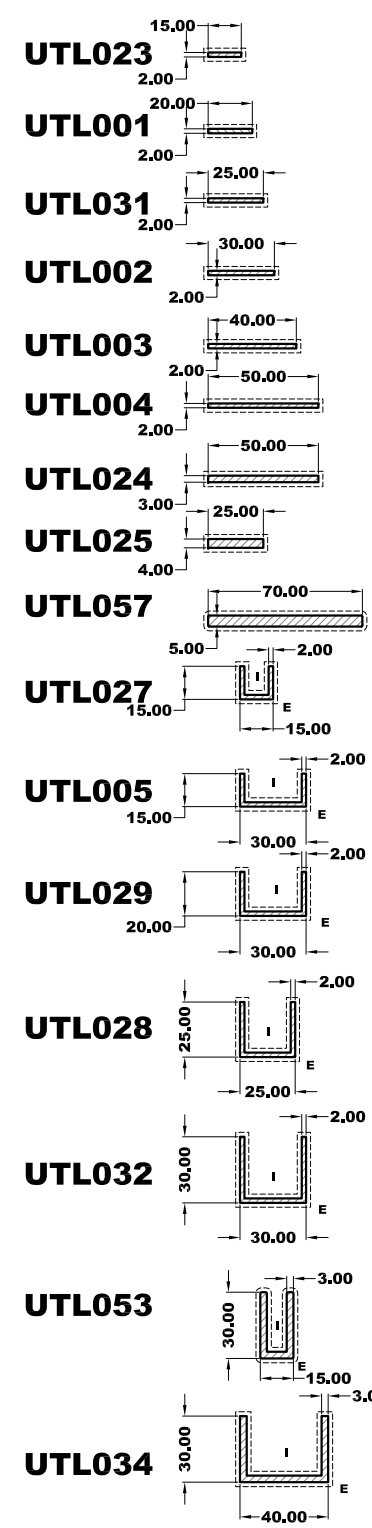

15/02/1999

TITLE

PL Standards / UTL - Wall Chart



Smart Systems Limited
Arnolds Way, Yatton,
North Somerset,
BS49 4QN
Tel: +44 (0)1934 876 100
Fax: +44 (0)1934 835 169
www.smartsystems.co.uk

CHECKED			
PRODUCT CODE			
MATERIAL	ISSUE MOD No.	DESCRIPTION	DATE
	DRAWN	DRAWN	DRAWING No.
	DATE	JULY_2010	
	SCALE	N.T.S.@A3	

No unauthorised use, copy or disclosure of this drawing is to be made.
It is to be returned whenever required.

ISSUE	MOD No.	DATE

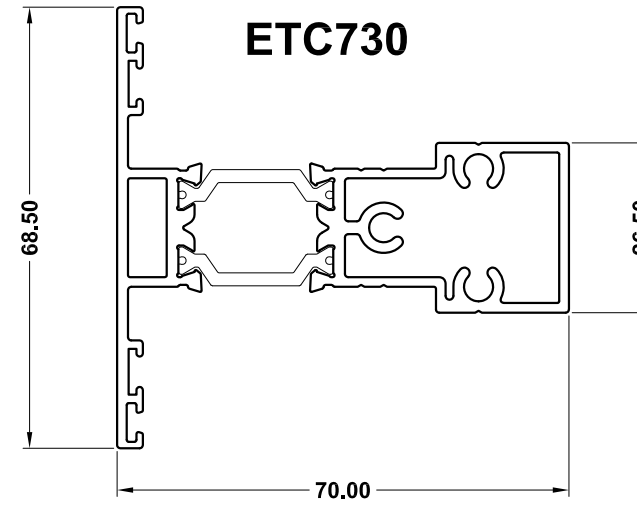
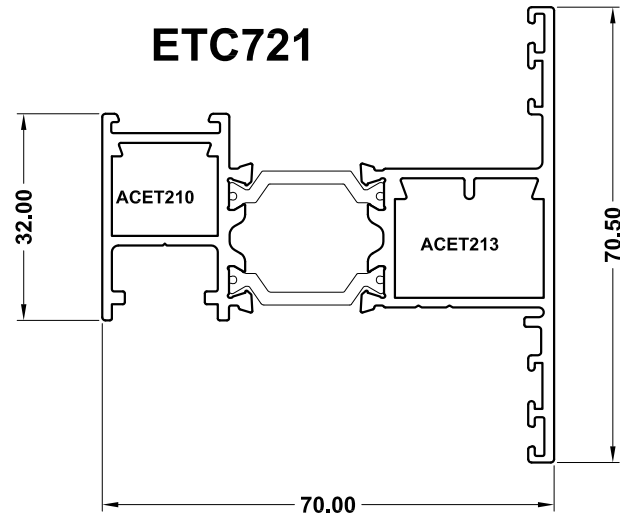
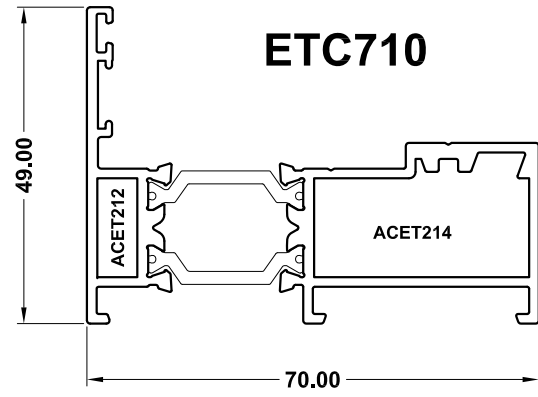

ETC765

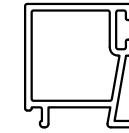

ETC766

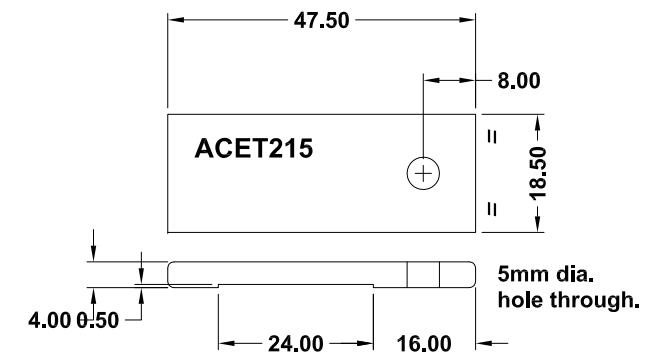
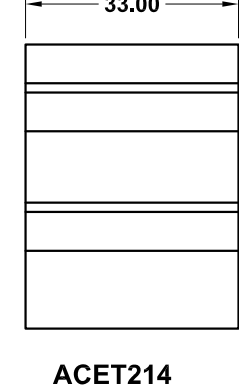
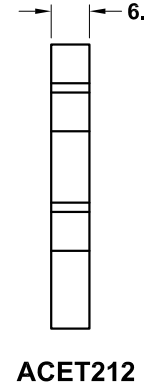
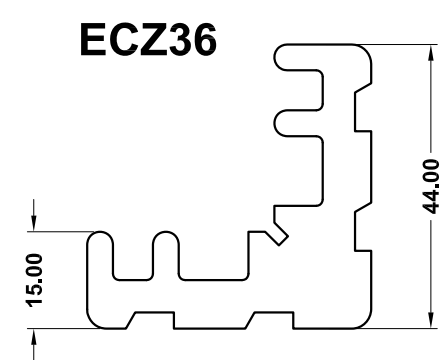
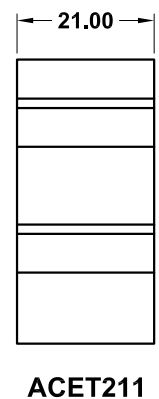
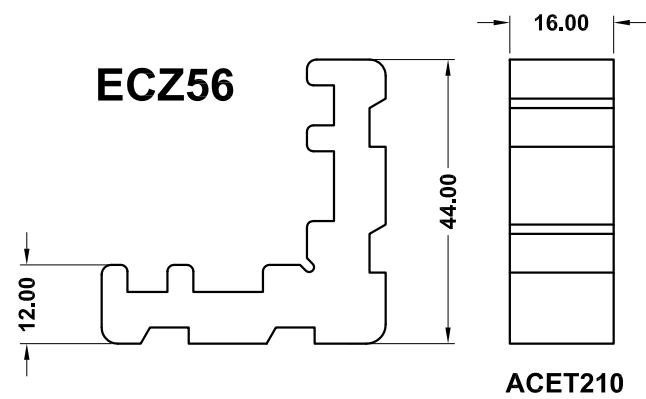
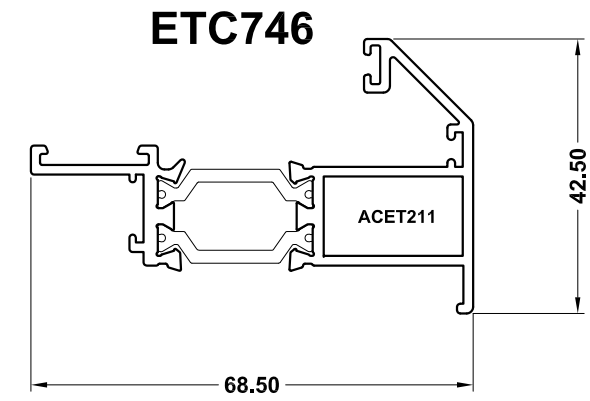
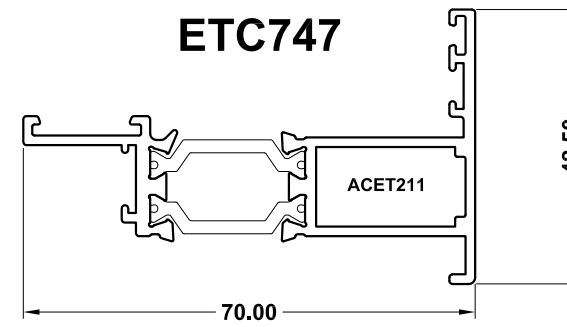
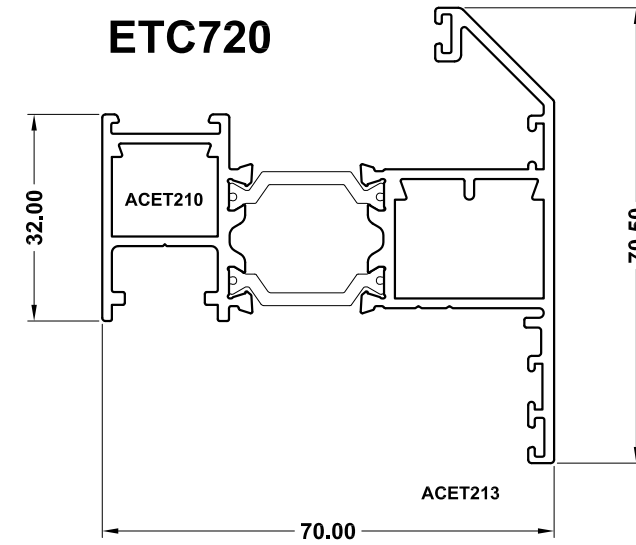
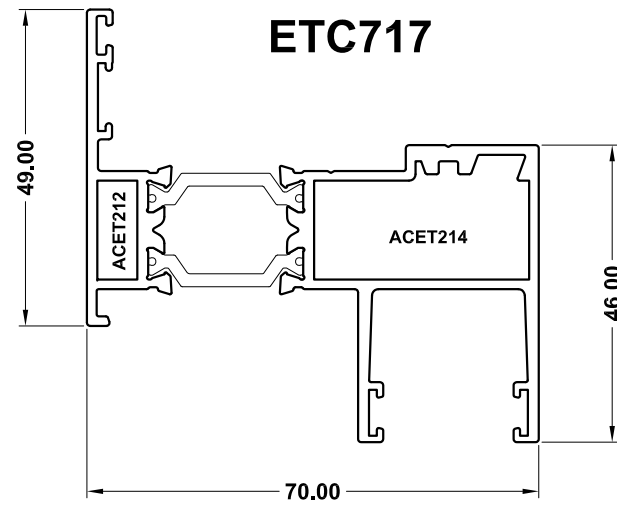
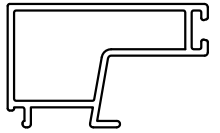

TITLE **Parallel Window - Wall Chart**

smart
architectural aluminium

Smart Systems Limited
Arnolds Way, Yatton,
North Somerset,
BS49 4QN
Tel: +44 (0)1934 876 100
Fax: +44 (0)1934 835 169
www.smartsystems.co.uk

CHECKED			
PRODUCT CODE			
MATERIAL			
	ISSUE	MOD No.	DESCRIPTION
	DATE	JULY_2010	
	SCALE	N.T.S.@A3	
			DRAWING No.

Copyright Smart Systems Ltd

MANUAL ROOF / MS

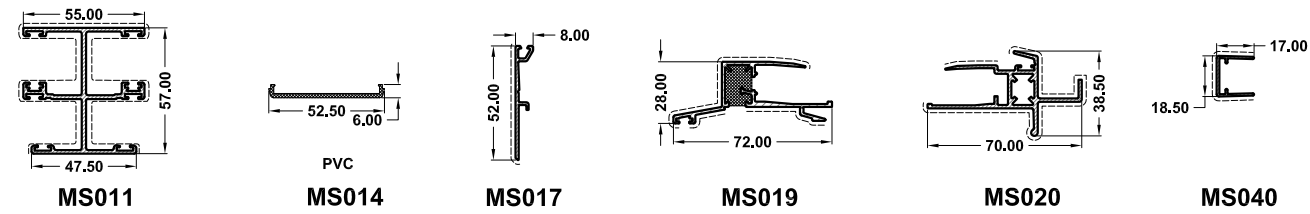

ROOF LIGHT / DR

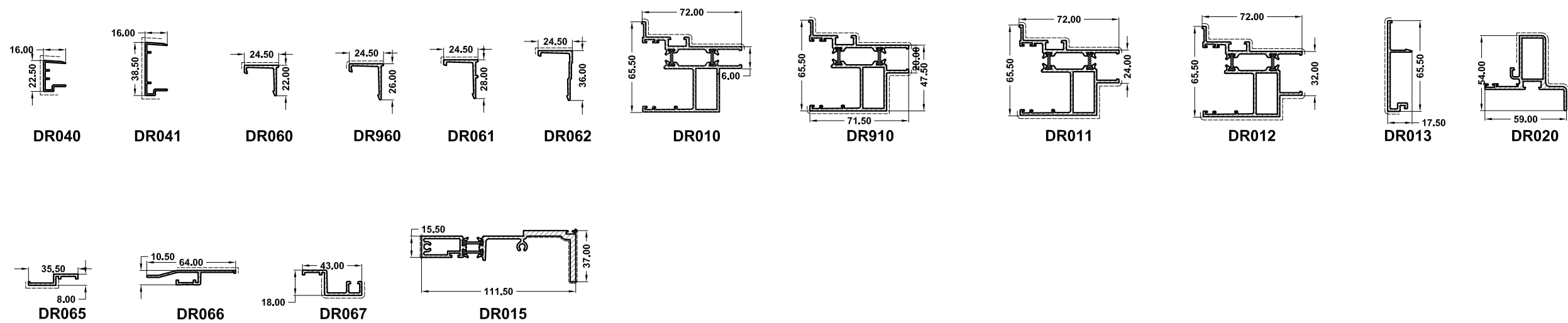

PERGOLA SYSTEM / APS

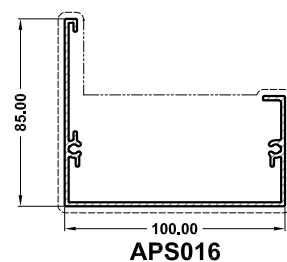

PERGOLA ROOF / PR

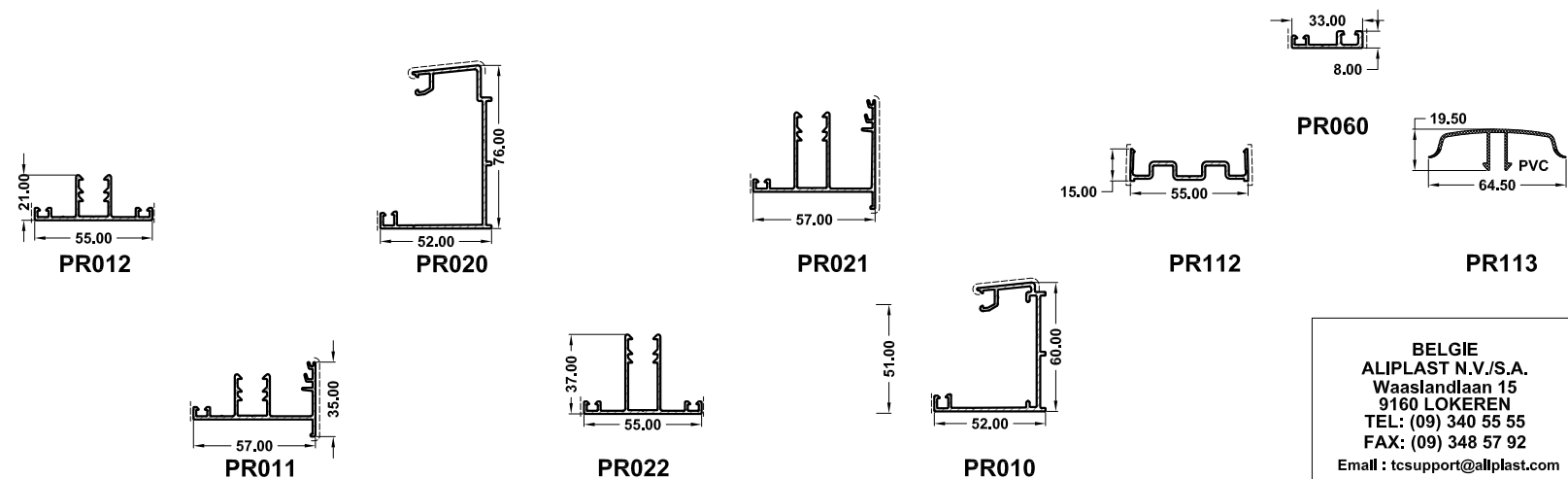

BELGIE
 ALIPLAST N.V./S.A.
 Waaslandlaan 15
 9160 LOKEREN
 TEL: (09) 340 55 55
 FAX: (09) 348 57 92
 Email : tcsupport@alplast.com

15/02/1999

TITLE

MS / DR / APS / PR - Wall Chart



Smart Systems Limited
 Arnolds Way, Yatton,
 North Somerset,
 BS49 4QN
 Tel: +44 (0)1934 876 100
 Fax: +44 (0)1934 835 169
 www.smartssystem.co.uk

CHECKED			
PRODUCT CODE			
MATERIAL	DRAWN	DRAWN	DRAWING No.
	DATE	JULY_2010	
	SCALE	N.T.S.@A3	

No unauthorised use, copy or disclosure of this drawing is to be made.
It is to be returned whenever required.

ISSUE	MOD No.	DATE
-------	---------	------

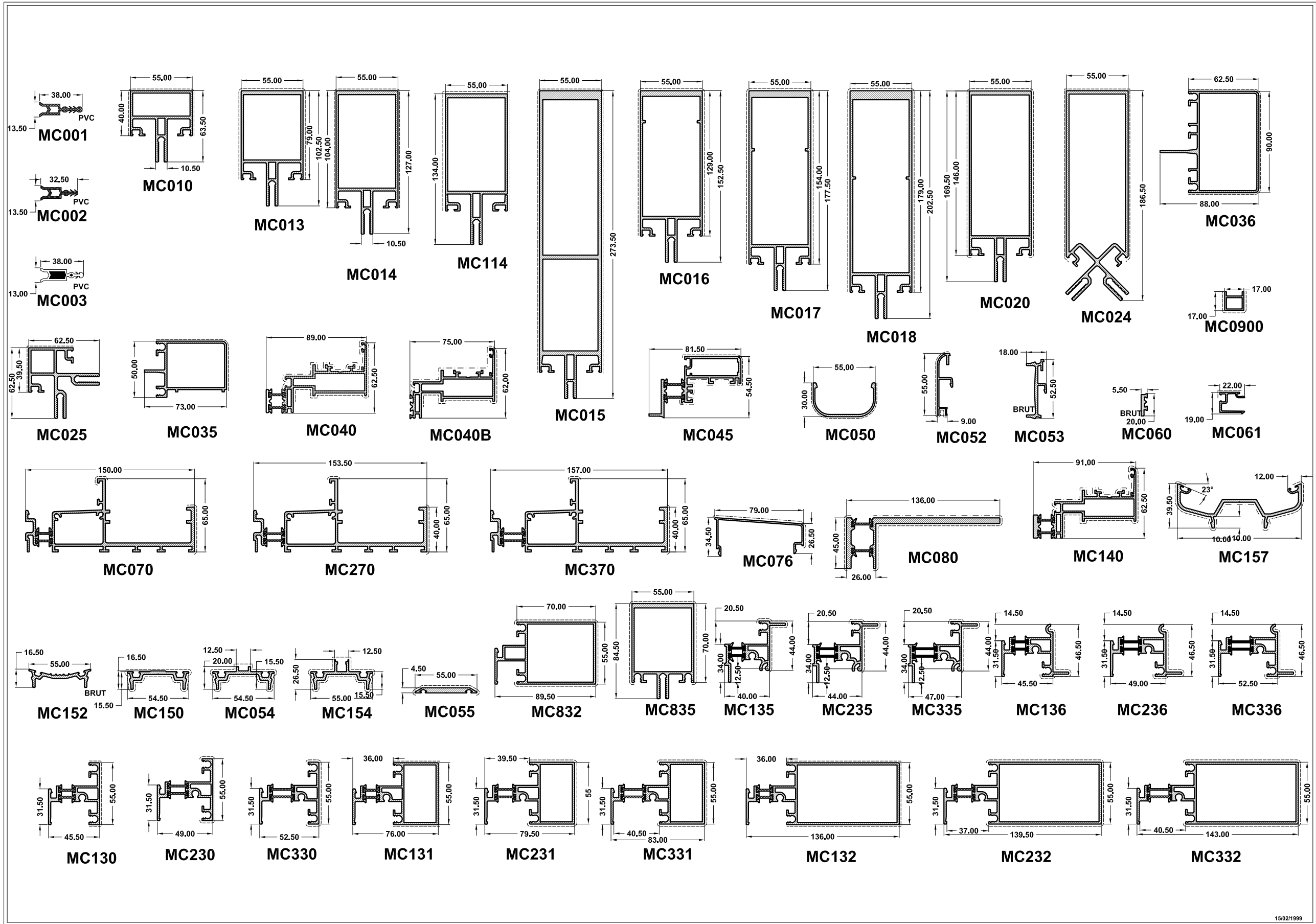

1502/1999

TITLE

MC Wall - Wall Chart

smart
architectural aluminium

Smart Systems Limited
Arnolds Way, Yatton,
North Somerset,
BS49 4QN
Tel: +44 (0)1934 876 100
Fax: +44 (0)1934 835 169
www.smartsystems.co.uk

CHECKED				
PRODUCT CODE				
MATERIAL	ISSUE	MOD No.	DESCRIPTION	DATE
	DRAWN	DRAWN		DRAWING No.
	DATE	JULY_2010		
	SCALE	N.T.S.@A3		

Copyright Smart Systems Ltd

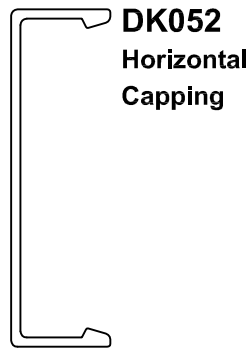

DK052
Horizontal
Capping

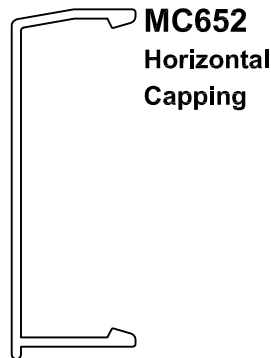

MC652
Horizontal
Capping

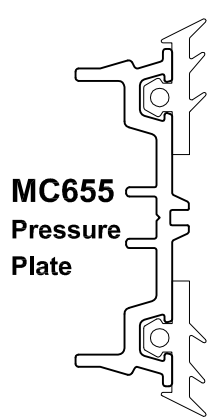

MC655
Pressure
Plate



DK154
Pressure
Plate

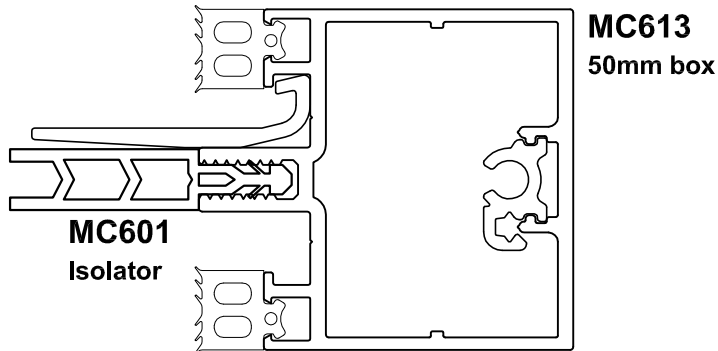

MC601
Isolator

MC613
50mm box

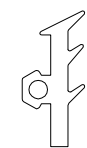

ACMC150
Pressure Plate Gasket



ACSC208
32mm Glazing

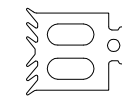

ACSC212
28mm Glazing

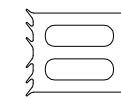

ACMC115
24mm Glazing

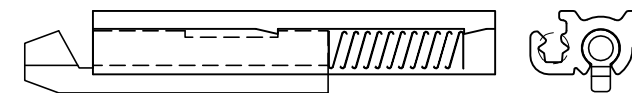

ACMC650
Spring Pin

ACMC630 (ECZ88)
Glazing Support

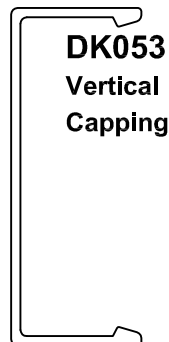

DK053
Vertical
Capping

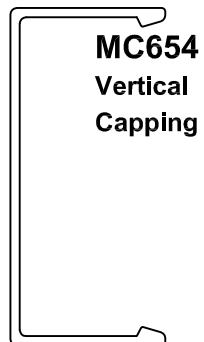

MC654
Vertical
Capping

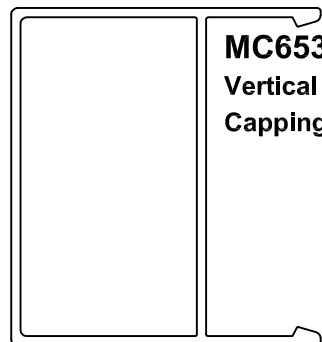

MC653
Vertical
Capping

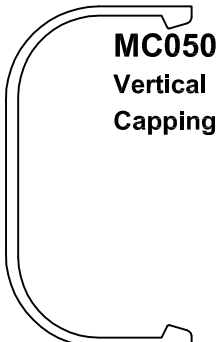

MC050
Vertical
Capping

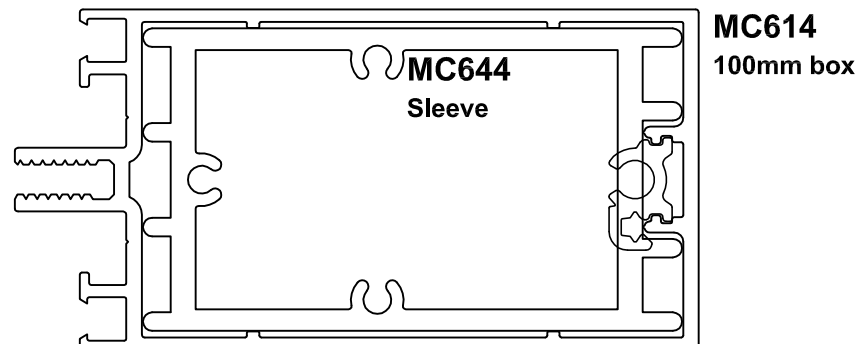

MC644
Sleeve

MC614
100mm box

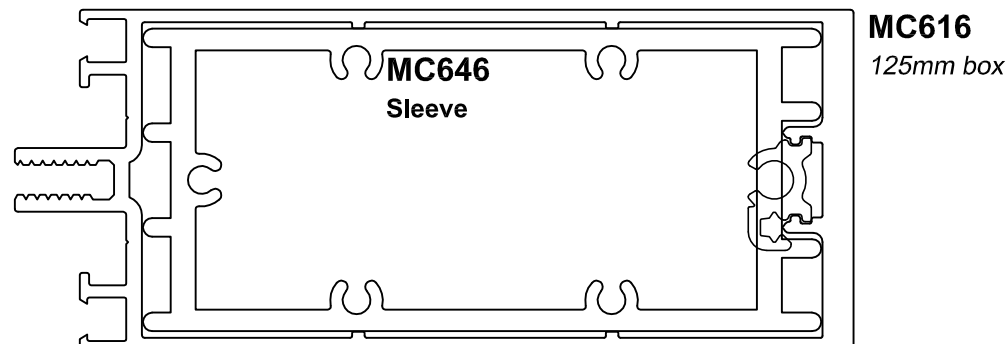

MC646
Sleeve

MC616
125mm box

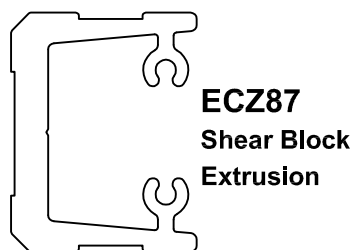

ECZ87
Shear Block
Extrusion

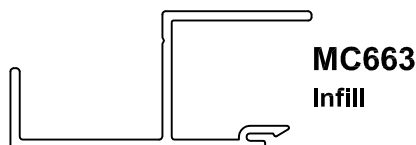

MC663
Infill

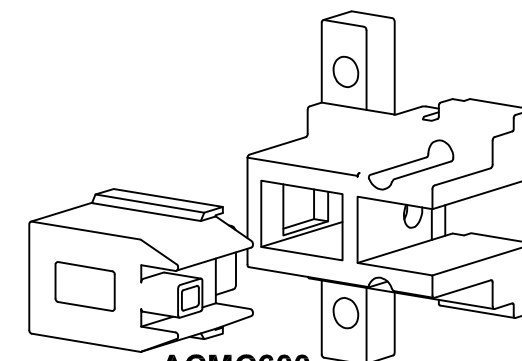

ACMC600
Fixing Bracket &
Rubber Insert

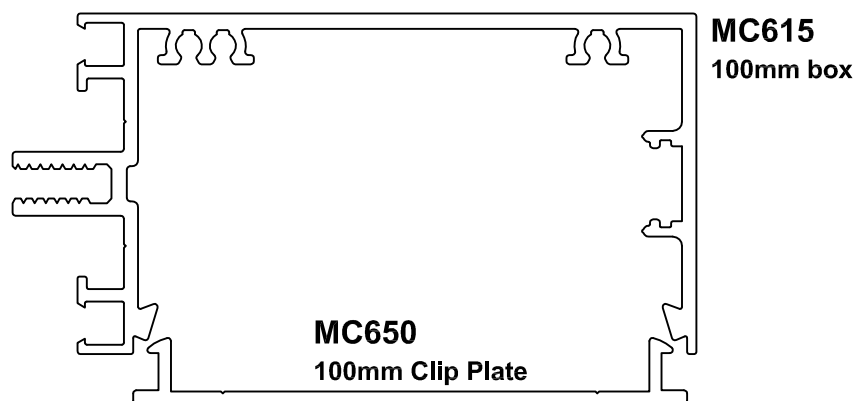

MC615
100mm box

MC650
100mm Clip Plate

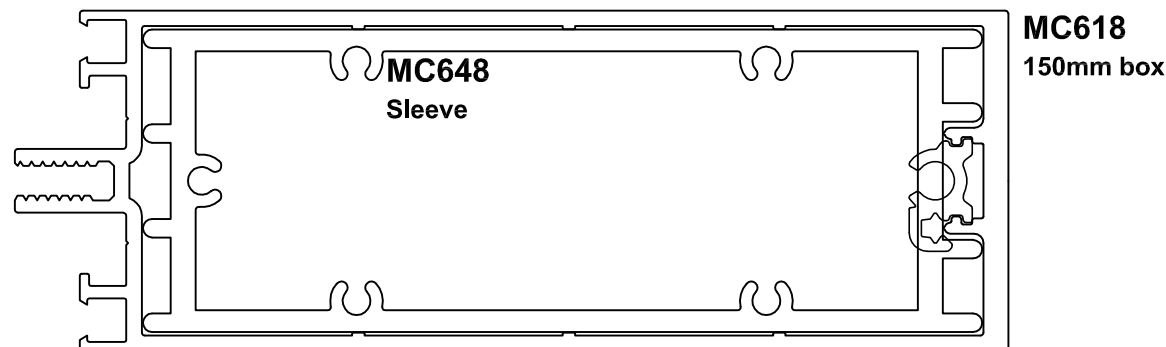

MC648
Sleeve

MC618
150mm box

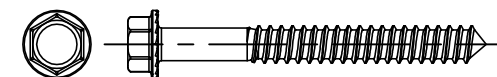

ACMC610
Pressure Plate Screw

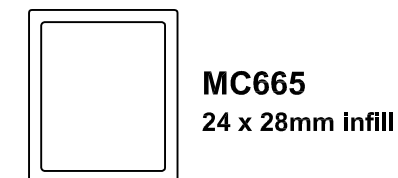

MC665
24 x 28mm infill

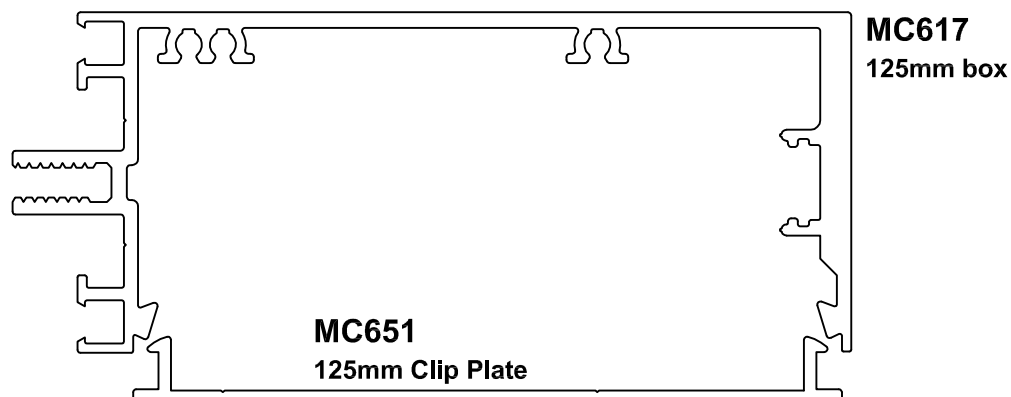

MC617
125mm box

MC651
125mm Clip Plate

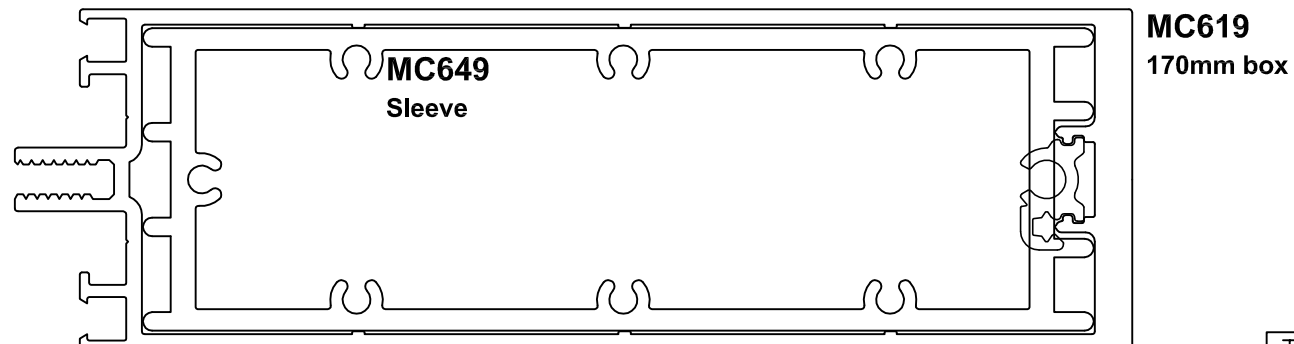

MC649
Sleeve

MC619
170mm box

LUXUS / LX

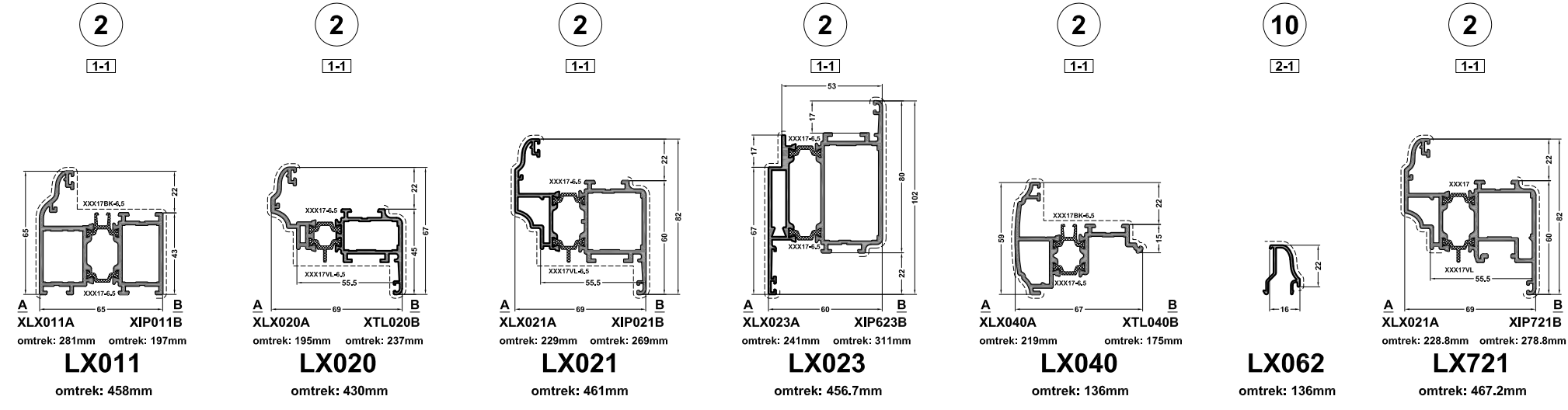

SUPERGLIDE / SG

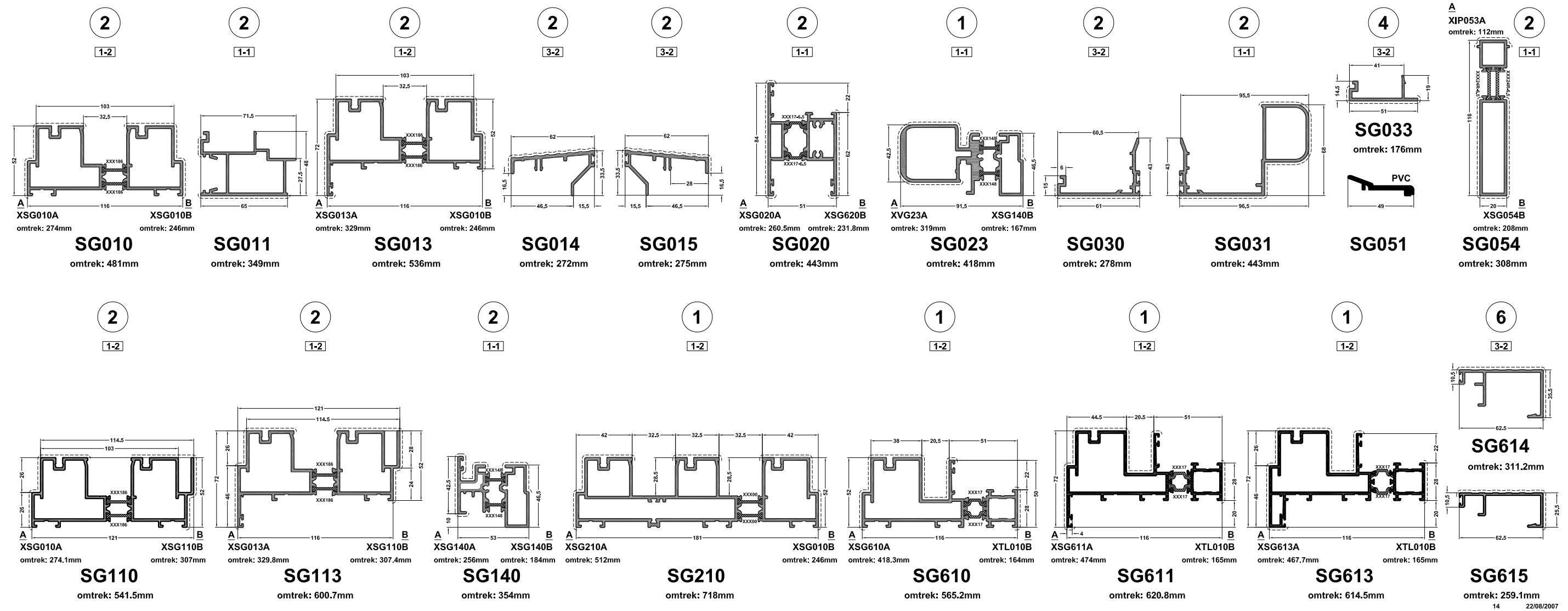

TITLE

Luxus / LX / Superglide / SG - Wall Chart



Smart Systems Limited
Arnolds Way, Yatton,
North Somerset,
BS49 4QN
Tel: +44 (0)1934 876 100
Fax: +44 (0)1934 835 169
www.smartsystems.co.uk

CHECKED				
PRODUCT CODE				
MATERIAL	ISSUE	MOD No.	DESCRIPTION	DATE
	DRAWN	D.N.		DRAWING No.
	DATE	JULY_2010		
	SCALE	N.T.S.@A3		

No unauthorised use, copy or disclosure of this drawing is to be made.
It is to be returned whenever required.

ISSUE	MOD No.	DATE

OUTERFRAME

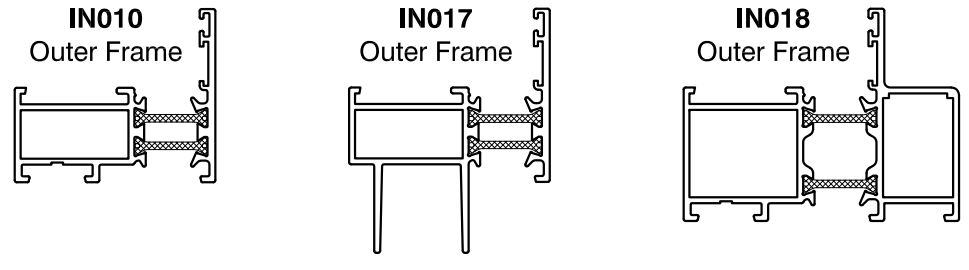

WINDOW VENT

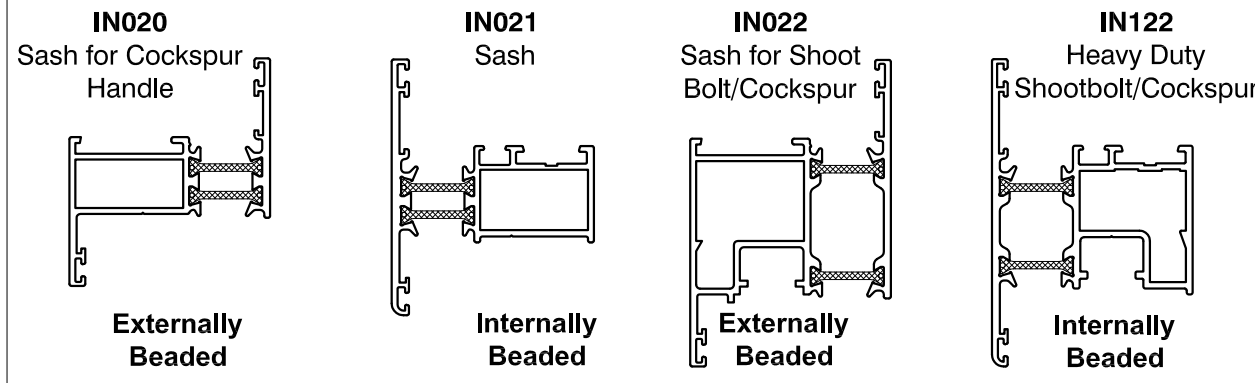

INFILL

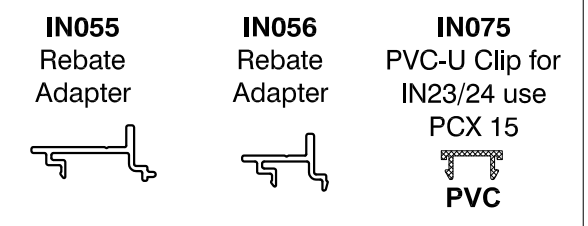

DOOR VENTFRAME

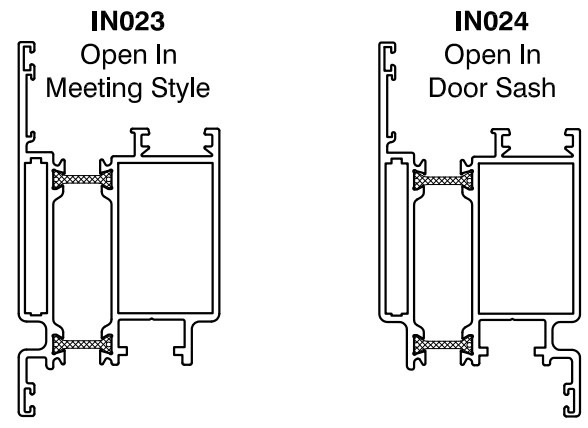

DISCONTINUED

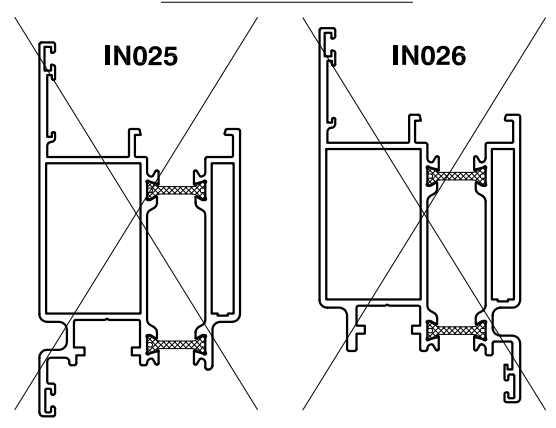

COUPLER

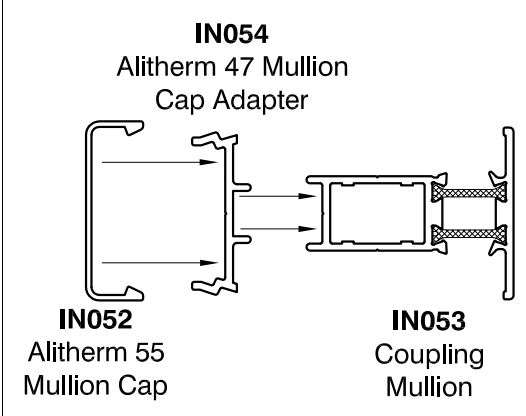

TRANSOM

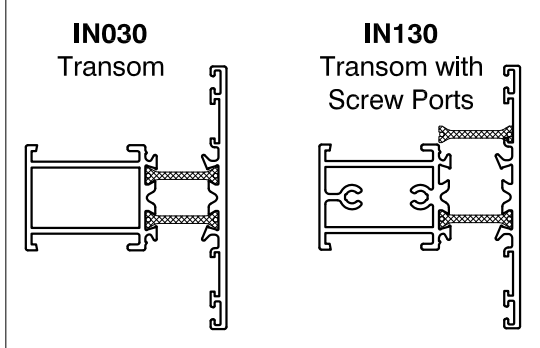

DISCONTINUED

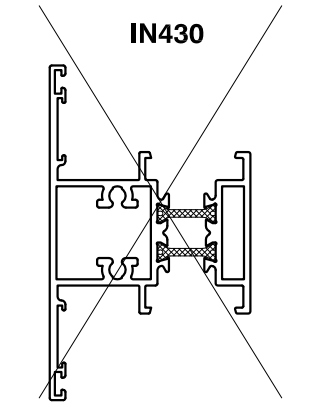

HEAD EXTENTION

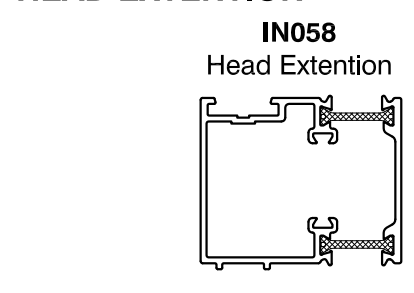

BEAD

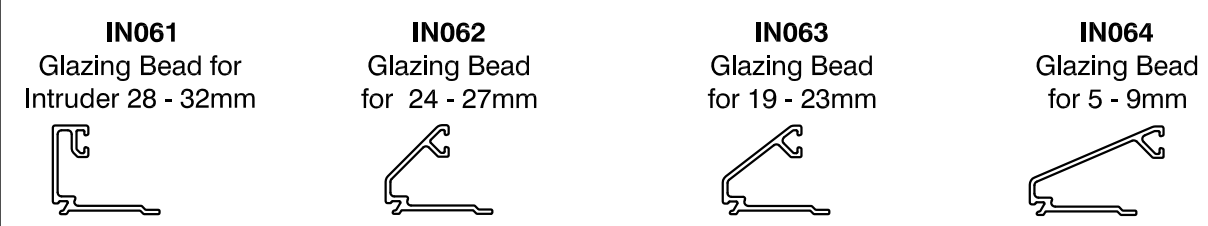

DRIP



BRUSH CARRIER



REVERSE ADAPTER

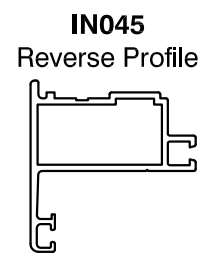

CILL



August 2006

TITLE
Intruder Window - Wall Chart

smart
architectural aluminium

Smart Systems Limited
Arnolds Way, Yatton,
North Somerset,
BS49 4QN
Tel: +44 (0)1934 876 100
Fax: +44 (0)1934 835 169
www.smartsystems.co.uk

CHECKED				
PRODUCT CODE				
MATERIAL	ISSUE	MOD No.	DESCRIPTION	DATE
	DRAWN	D.N.	DRAWING No.	
	DATE	JULY_2010		
	SCALE	N.T.S.@A3		
Copyright Smart Systems Ltd				

INTRUDER / IN

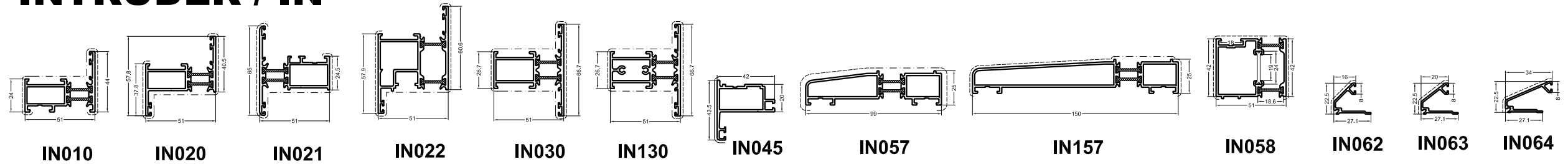

TRILINE/TL

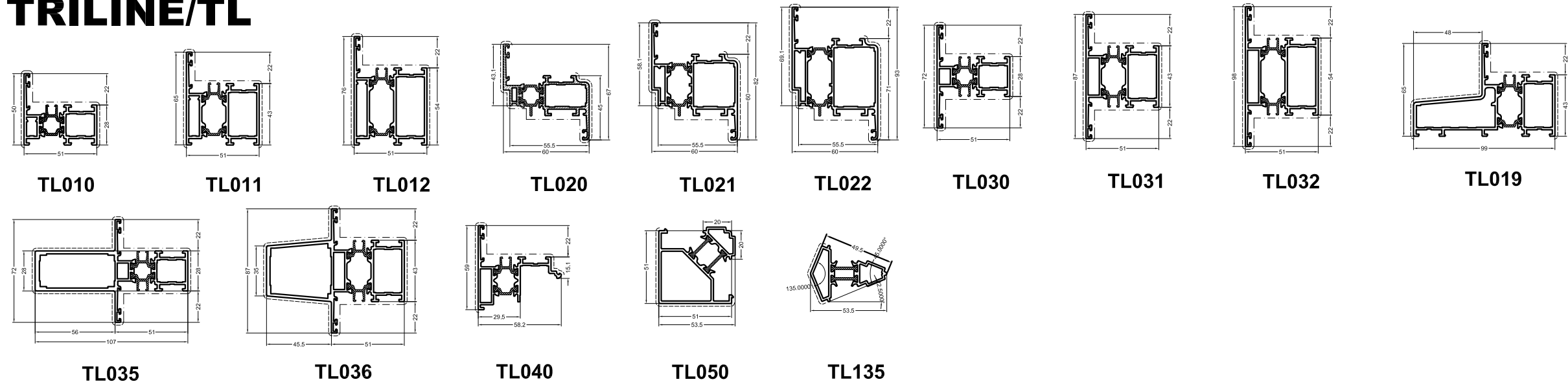

SLIDE / SL

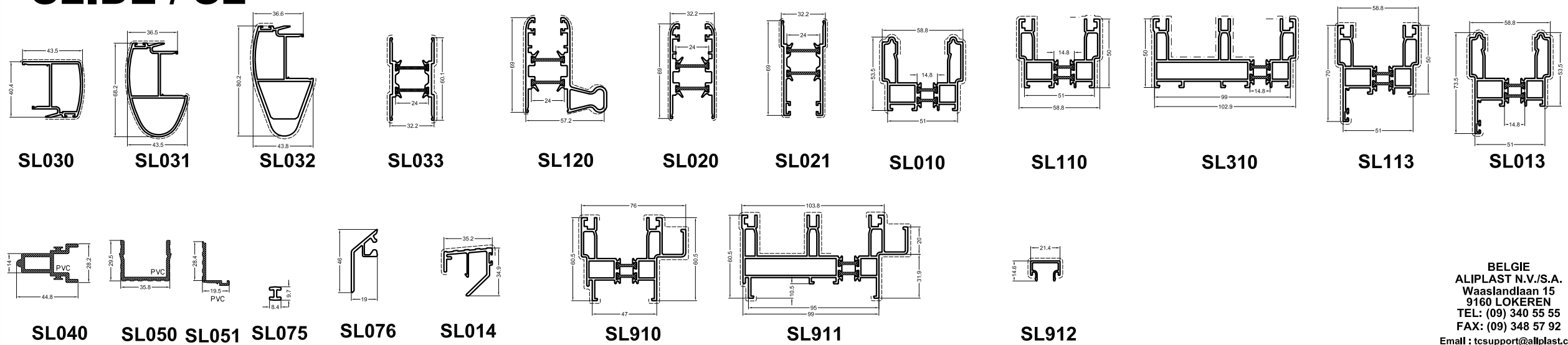

BELGIE
ALIPLAST N.V./S.A.
Waaslandlaan 15
9160 LOKEREN
TEL: (09) 340 55 55
FAX: (09) 348 57 92
Email : tcsupport@aliplast.com

15/02/1999

TITLE

Intruder / Triline / Slide - Wall Chart

smart
architectural aluminium

Smart Systems Limited
Arnolds Way, Yatton,
North Somerset,
BS49 4QN
Tel: +44 (0)1934 876 100
Fax: +44 (0)1934 835 169
www.smartsystems.co.uk

CHECKED				
PRODUCT CODE				
MATERIAL	ISSUE	MOD No.	DESCRIPTION	DATE
	DRAWN	DRAWN		DRAWING No.
	DATE	JULY_2010		
	SCALE	N.T.S.@A3		

No unauthorised use, copy or disclosure of this drawing is to be made.
It is to be returned whenever required.

ISSUE	MOD No.	DATE

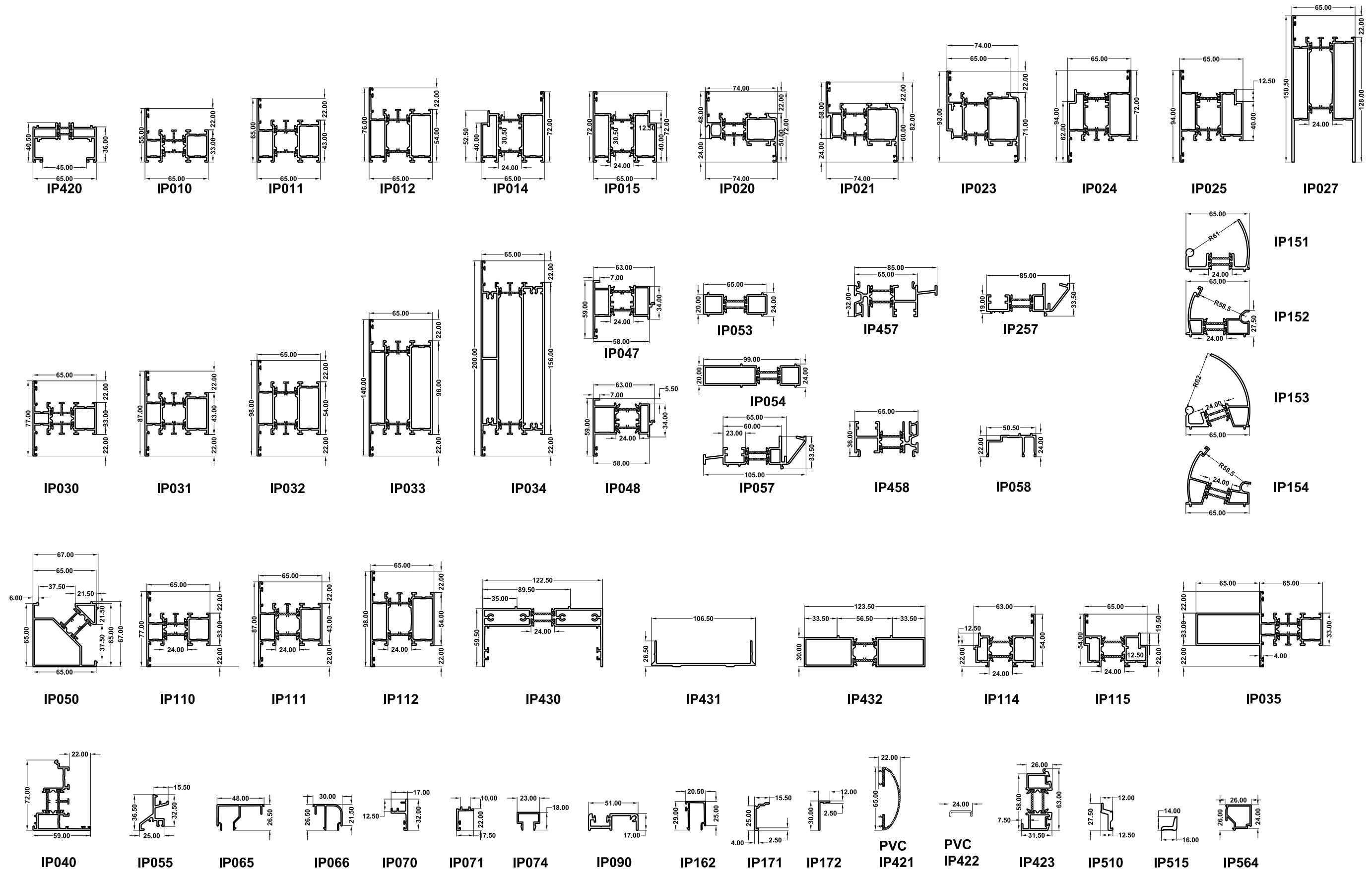

TITLE

Imperial - Wall Chart











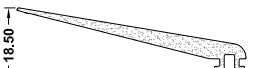





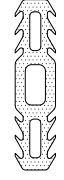













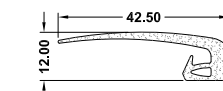
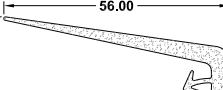
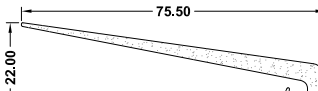



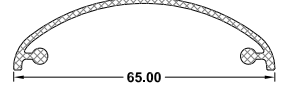
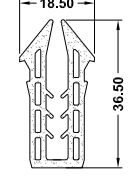
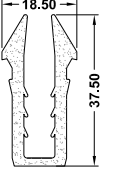
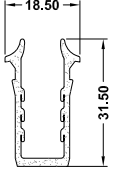

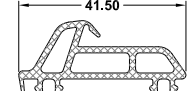



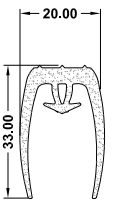
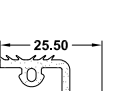
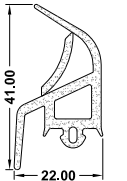
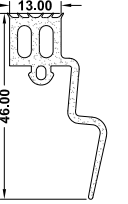
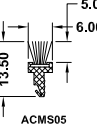
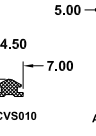
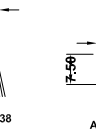
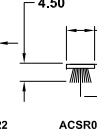
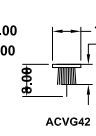
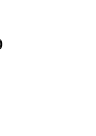

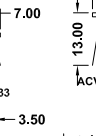
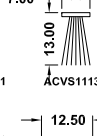
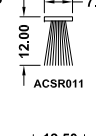

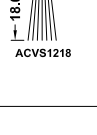
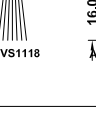
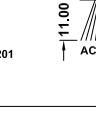
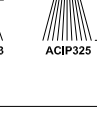
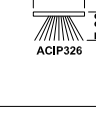

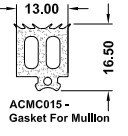
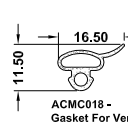
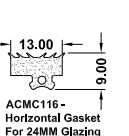
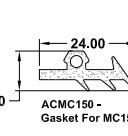
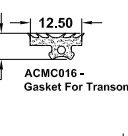
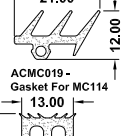
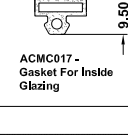
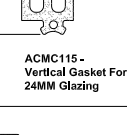

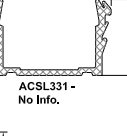

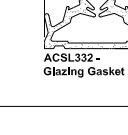
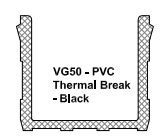

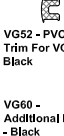







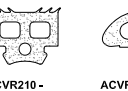

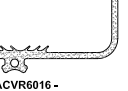

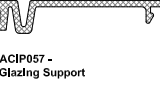

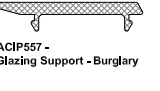

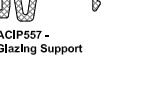

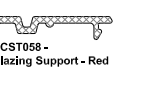
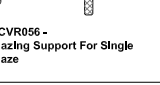
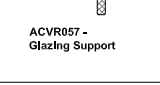
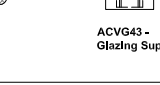

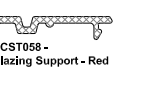
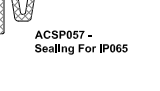
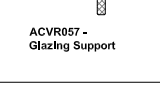
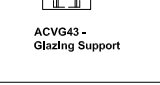









Smart Systems Limited
Arnolds Way, Yatton,
North Somerset,
BS49 4QN
Tel: +44 (0)1934 876 100
Fax: +44 (0)1934 835 169
www.smartsystems.co.uk

CHECKED			
PRODUCT CODE			
MATERIAL			
	ISSUE	MOD No.	DESCRIPTION
	DATE	JULY_2010	
	SCALE	N.T.S.@A3	
			DRAWING No.

No unauthorised use, copy or disclosure of this drawing is to be made.
It is to be returned whenever required.

ISSUE MOD No. DATE

 ACVR502 - Weathering Gasket Gutter For VR521  ACVR202 - Ridge Seal Strip Wall - White  ACMS02 - Seal Strip Wall For Manual Sliding Roof	 ACVL031 - Gasket For Inside Opening  ACVL031N - Gasket For Inside Opening  ACVL032 - Glazing Gasket  ACVL032N - Gasket For Outside Opening  ACTL232 - Gasket For Doors  ACVL035 - Coupling Gasket	 ACDV202N - Gasket DV  ACDV203 - Gasket  ACDR132 - Rubber Seal For Roof Light  ACDR133 - High Rubber Seal For Roof Light	 ACDV030 - Flipper Gasket  ACRV031 - Head Gasket  ACRV030 - Flipper Gasket  ACRV032 - Infill Section  ACRV031 - Head Gasket  ACRV032 - Infill Section	 ACVT110 - Gasket For VT20 & VT091 - VT192  ACVR270 - Gasket For VR2720 / 2721  ACVN032 - Gasket For Outside 3MM  ACVN034 - Gasket For Outside 5MM	 ACVR108 - Glazing Gasket For Conservatory  ACVR109 - Glazing Gasket For Conservatory  ACVR110 - Ridge Seal Strip Wall
 ACIP075 - Coupling Gasket  ACAR010 - No Info.  ACIP656 - No Info.  ACFL020 - Gasket For FL525  ACIP431 - Swing Door Rubber Seal	 ACMAC002 - Gasket For 2MM  ACMAC006 - Gasket For 6MM  ACMAC009 - Gasket For 8-9.5MM	 ACIP030 - Central Gasket For Imperial  ACSP030 - Central Gasket  ACVL030 - Central Gasket For Visoline  ACDV030 - No Info.  ACTL030 - Central Gasket For Trilite	 ACVL208 - Glazing Gasket For Conservatory - White  ACVT012 - Gasket For VT032  ACVR449 - Weathering Gasket  ACVT112 - High Gasket For VT032		
 ACMS05  ACVS010  ACIP438  ACSVG22  ACSR012  ACSVG42  ACDV205  ACSR012A  ACVL033  ACVS1211  ACVS1113  ACSR011  ACVS1218  ACVS1118  ACDV201  ACSR013  ACIP325  ACIP326	 ACMC015 - Gasket For Mullion  ACMC018 - Gasket For Vent  ACMC116 - Horizontal Gasket For 24MM Glazing  ACMC150 - Gasket For MC150  ACMC016 - Gasket For Transom  ACMC019 - Gasket For MC114  ACMC017 - Gasket For Inside Glazing  ACMC115 - Vertical Gasket For 24MM Glazing	 ACSL031 - Glazing Gasket Glass 20 - 21MM  ACSL032 - Glazing Gasket 22 - 23MM  ACSL331 - No Info.  ACSL033 - Glazing Gasket Glass 6 - 9MM  ACSL332 - Glazing Gasket 24MM	<p>PVC</p>  VG50 - PVC Thermal Break - Black  VG51 - PVC Thermal Break For Sliding Door - Black  VG52 - PVC Infill Trim For VG10 - Black  VG60 - Additional Profile - Black  VG54 - Interlock For PB30-31		
 ACVR200 - Glazing Gasket - Conservatory  ACVR201A - Gasket For Veranda  ACVR212 - Gasket For IN045  ACVR201 - Gasket With Lip  ACVR209 - Gasket For Hinge Profile - White  ACVR214 - Sealing Gasket For Mullion  ACVR210 - Gasket 9MM For VR537 - VR538  ACVR620 - Gasket For VR621  ACVR6016 - Glazing Gasket For VR6000  ACVR314 - High Sealing Strip Gutter	 ACIP057 - Glazing Support  ACIN057 - Glazing Support  ACIP557 - Glazing Support - Burglary  ACIN058 - Clip For Glazing Bead  ACLV057 - Glazing Support  ACIP557 - Glazing Support  ACIN058 - Clip For Glazing Bead  ACLV057 - Glazing Support  ACIP557 - Glazing Support  ACIN058 - Clip For Glazing Bead  ACLV057 - Glazing Support	 ACST057 - Glazing Support  ACST058 - Glazing Support - Red  ACSP057 - Sealing For IP065  ACVR057 - Glazing Support  ACGV43 - Glazing Support	<p>GLAZING GASKET</p>  ACGV231 - 2MM (Outside)  ACGV231N - 2MM (Outside)  ACGV32 - 3MM  ACGV32N - 3MM  ACGV31 - 3MM (Outside)  ACGV31N - 3MM (Outside)  ACSP031 - 3MM (Outside)  ACGV33 - 4MM  ACGV33N - 4MM  ACGV131 - 4MM (Outside)  ACGV131N - 4MM (Outside)  ACGV34 - 5MM  ACGV34N - 5MM  ACGV340 - 6MM  ACGV340N - 6MM  ACGV49 - 7MM  SG51 - PVC Chicane For Sliding Doors		

BELGIE
ALIPLAST N.V./S.A.
Wassendaan 15
9160 LOKEREN
TEL: (09) 340 55 55
FAX: (09) 348 57 92
Email: tcsupport@alipplast.com

07/12/2004

TITLE

Gaskets - Wall Chart

smart
architectural aluminium

Smart Systems Limited
Arnolds Way, Yatton,
North Somerset,
BS49 4QN
Tel: +44 (0)1934 876 100
Fax: +44 (0)1934 835 169
www.smartsystems.co.uk

CHECKED				
PRODUCT CODE				
MATERIAL	ISSUE	MOD No.	DESCRIPTION	DATE
	DRAWN	DRAWN		DRAWING No.
	DATE	JULY_2010		
	SCALE	N.T.S.@A3		

Copyright Smart Systems Ltd

No unauthorised use, copy or disclosure of this drawing is to be made.
It is to be returned whenever required.

ISSUE	MOD No.	DATE

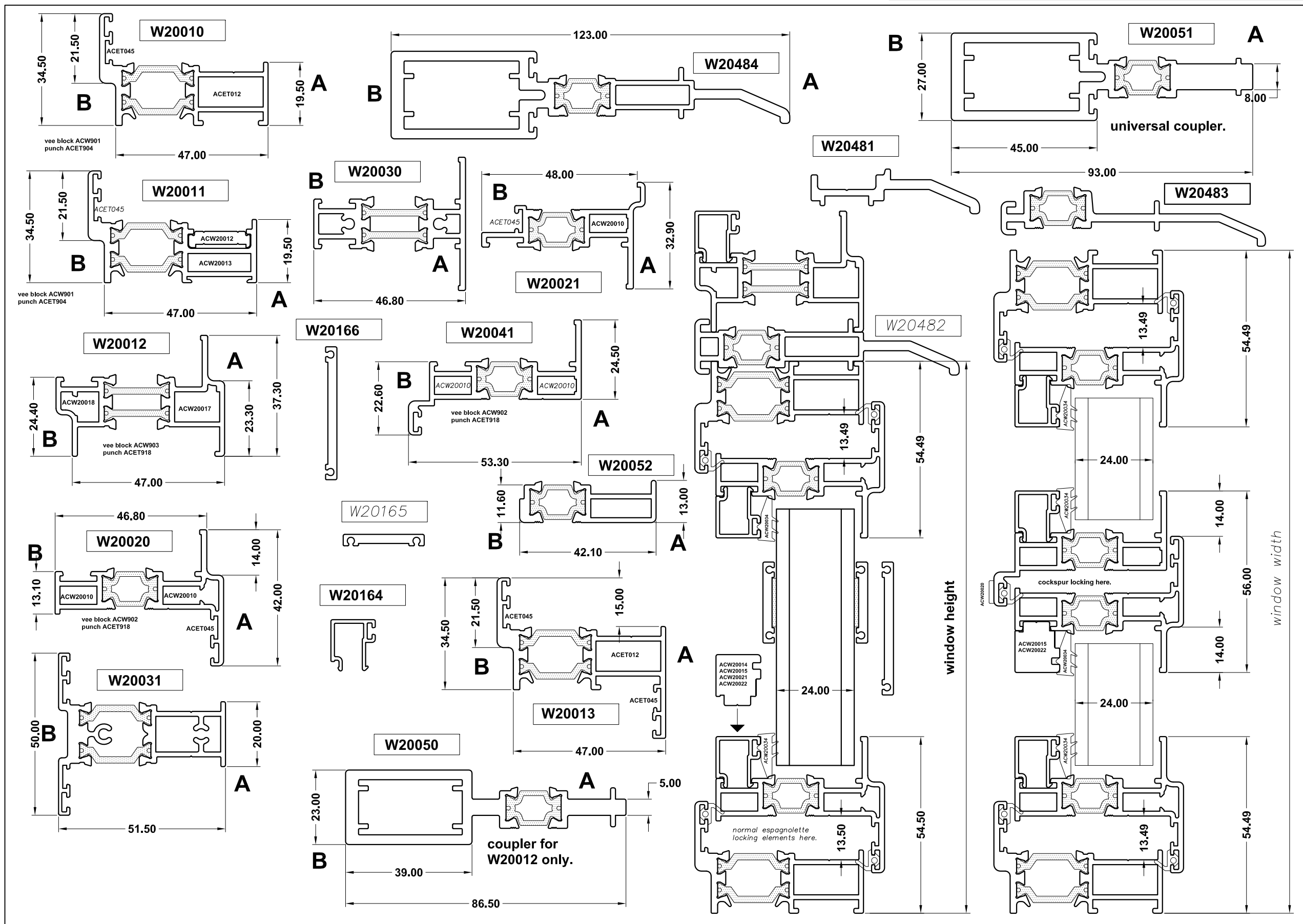

TITLE

Evolution - Wall Chart

smart
architectural aluminium

Smart Systems Limited
Arnolds Way, Yatton,
North Somerset,
BS49 4QN
Tel: +44 (0)1934 876 100
Fax: +44 (0)1934 835 169
www.smartsystems.co.uk

CHECKED			
PRODUCT CODE			
MATERIAL			
ISSUE	MOD No.	DESCRIPTION	DATE
DRAWN	D.N.		DRAWING No.
DATE	JULY_2010		
SCALE	N.T.S.@A3		

No unauthorised use, copy or disclosure of this drawing is to be made.
It is to be returned whenever required.

ISSUE	MOD No.	DATE

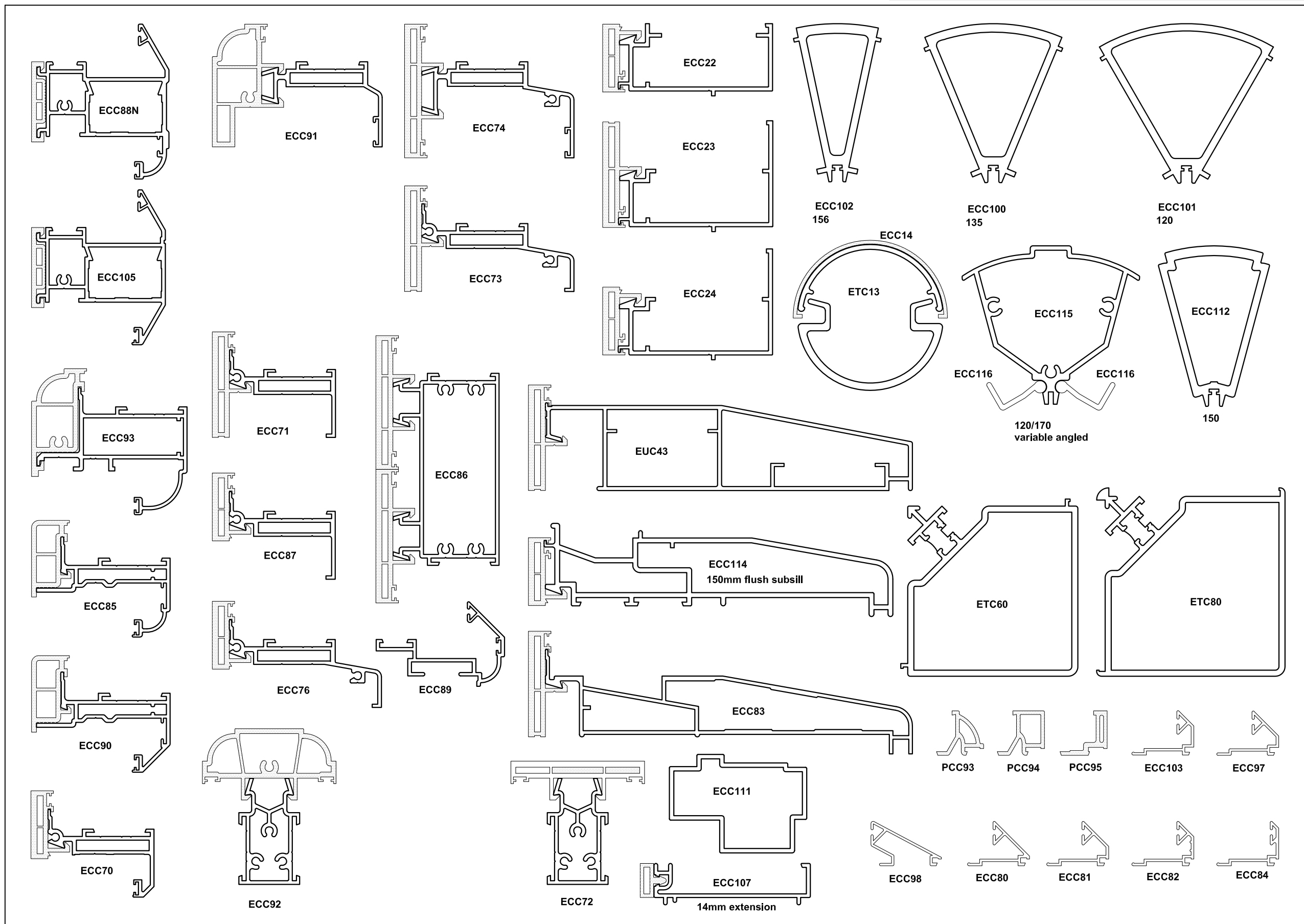

TITLE

Duotherm Elite - Wall Chart

smart
architectural aluminium

Smart Systems Limited
Arnolds Way, Yatton,
North Somerset,
BS49 4QN
Tel: +44 (0)1934 876 100
Fax: +44 (0)1934 835 169
www.smartsystems.co.uk

CHECKED				
PRODUCT CODE				
MATERIAL				
	ISSUE	MOD No.	DESCRIPTION	DATE
	DRAWN	D.N.		DRAWING No.
	DATE	JULY_2010		
	SCALE	N.T.S.@A3		

No unauthorised use, copy or disclosure of this drawing is to be made.
It is to be returned whenever required.

ISSUE	MOD No.	DATE

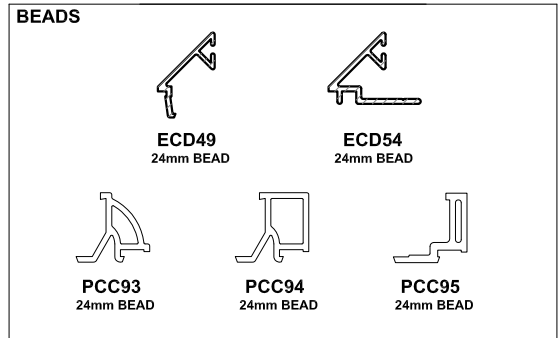
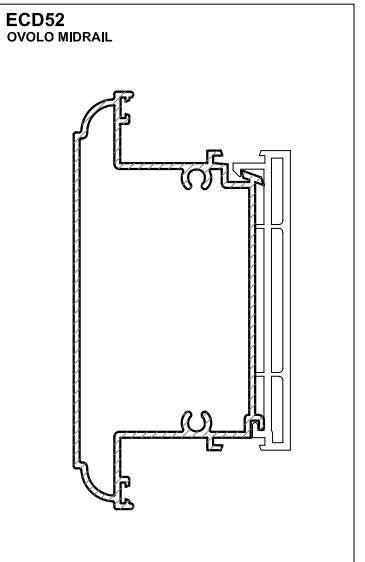
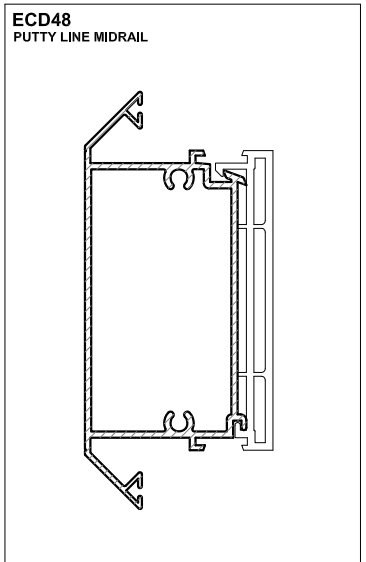
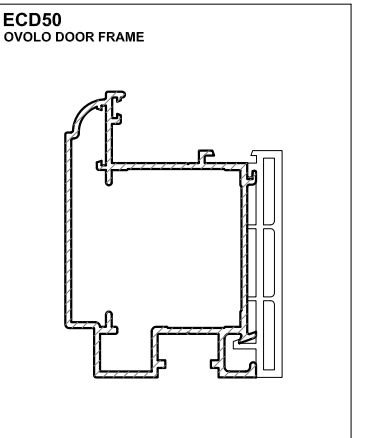
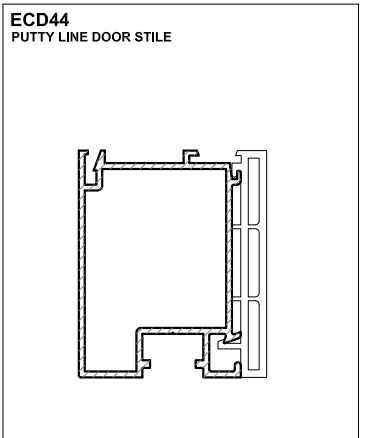
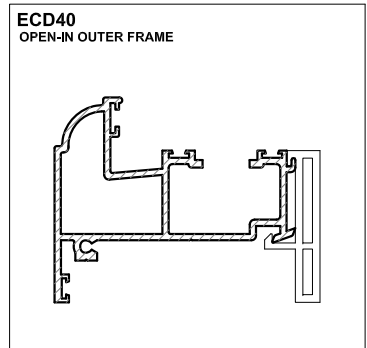

GASKETS AND GLAZING OPTIONS		
EXTERNAL WEDGE	GLASS THICKNESS AND BEAD REFERENCE	INTERNAL GASKET
RCA015BLZ	24mm DOUBLE GLAZING USING BEAD PCC93	WCA149BLZ
	24mm DOUBLE GLAZING USING BEAD PCC94	
RCA018BLZ	24mm DOUBLE GLAZING USING BEADS ECD49 WITH PCC95	
	24mm DOUBLE GLAZING USING BEADS ECD54 WITH PCC95	

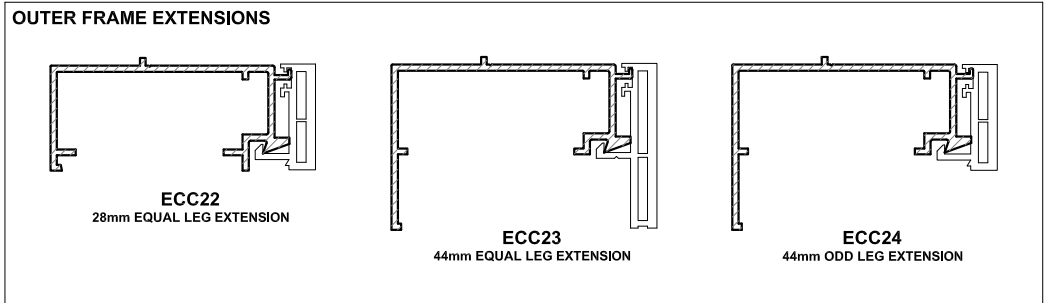
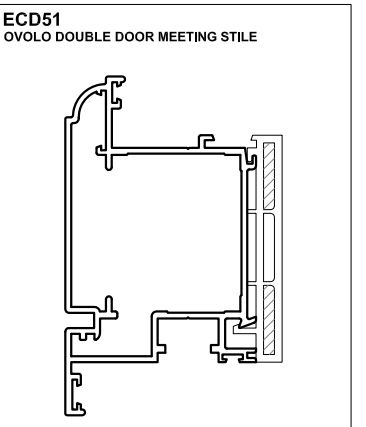
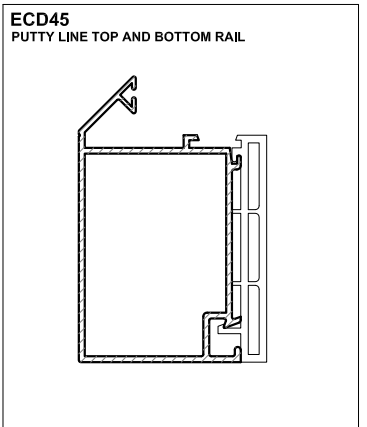
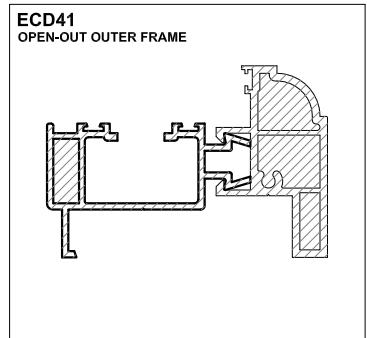

WEATHERSEALS	
RCA014BLZ GASKET	WUA086BLZ BUBBLE SEAL

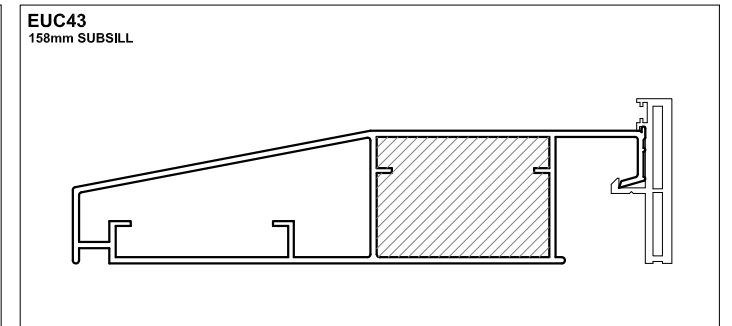
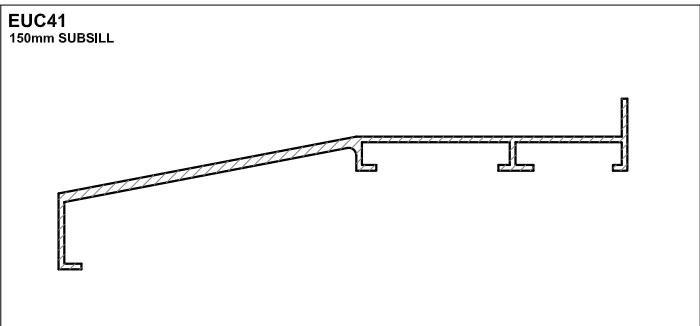
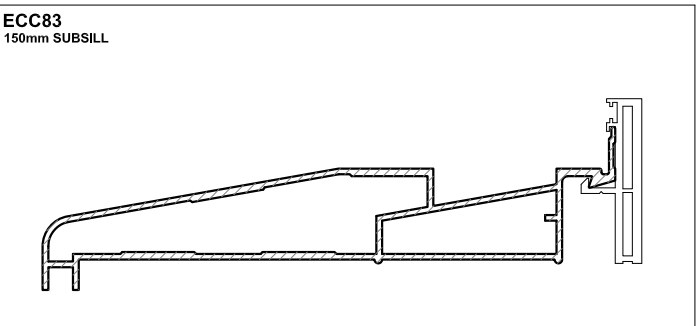
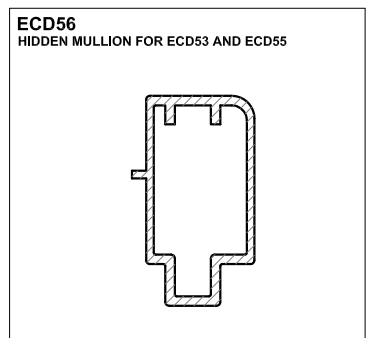
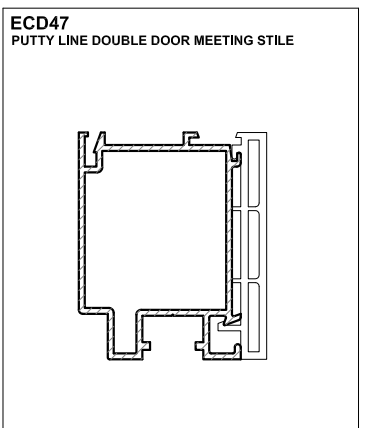
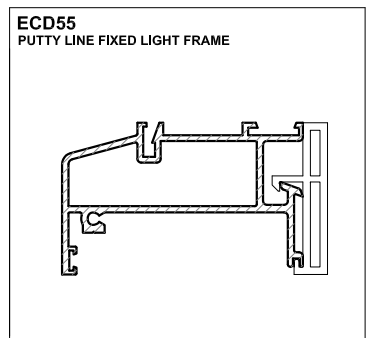
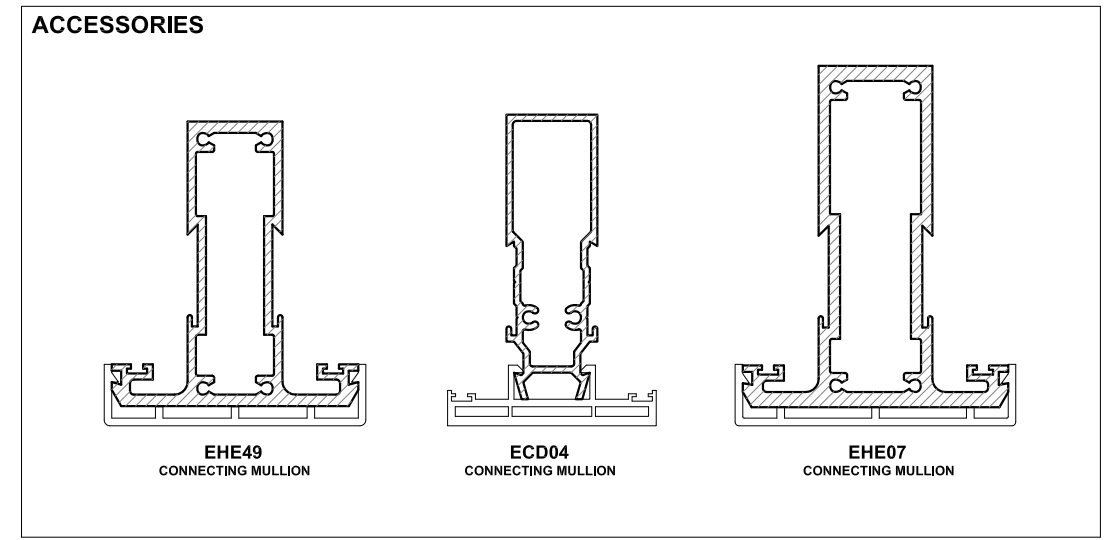
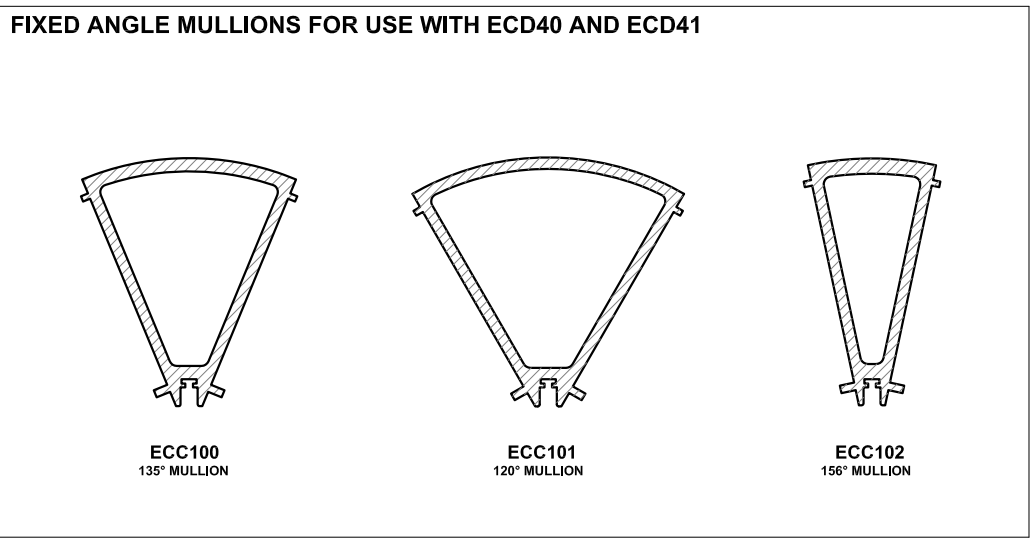
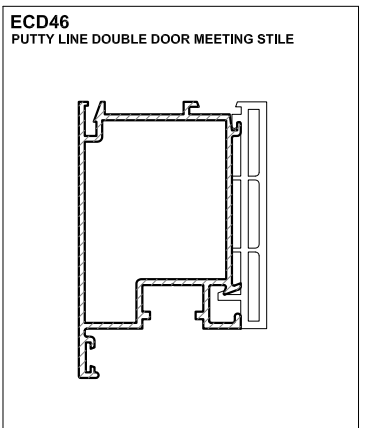
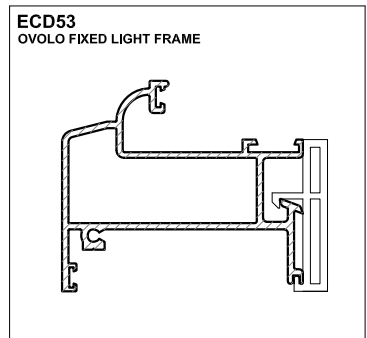

TITLE
Duotherm Door - Wall Chart

smart
architectural aluminium

Smart Systems Limited
Arnolds Way, Yatton,
North Somerset,
BS49 4QN
Tel: +44 (0)1934 876 100
Fax: +44 (0)1934 835 169
www.smartsystems.co.uk

CHECKED			
PRODUCT CODE			
MATERIAL			
ISSUE	MOD No.	DESCRIPTION	DATE
DRAWN	D.N.	DRAWING No.	
DATE	JULY_2010		
SCALE	N.T.S.@A3		

ALIVER / VR

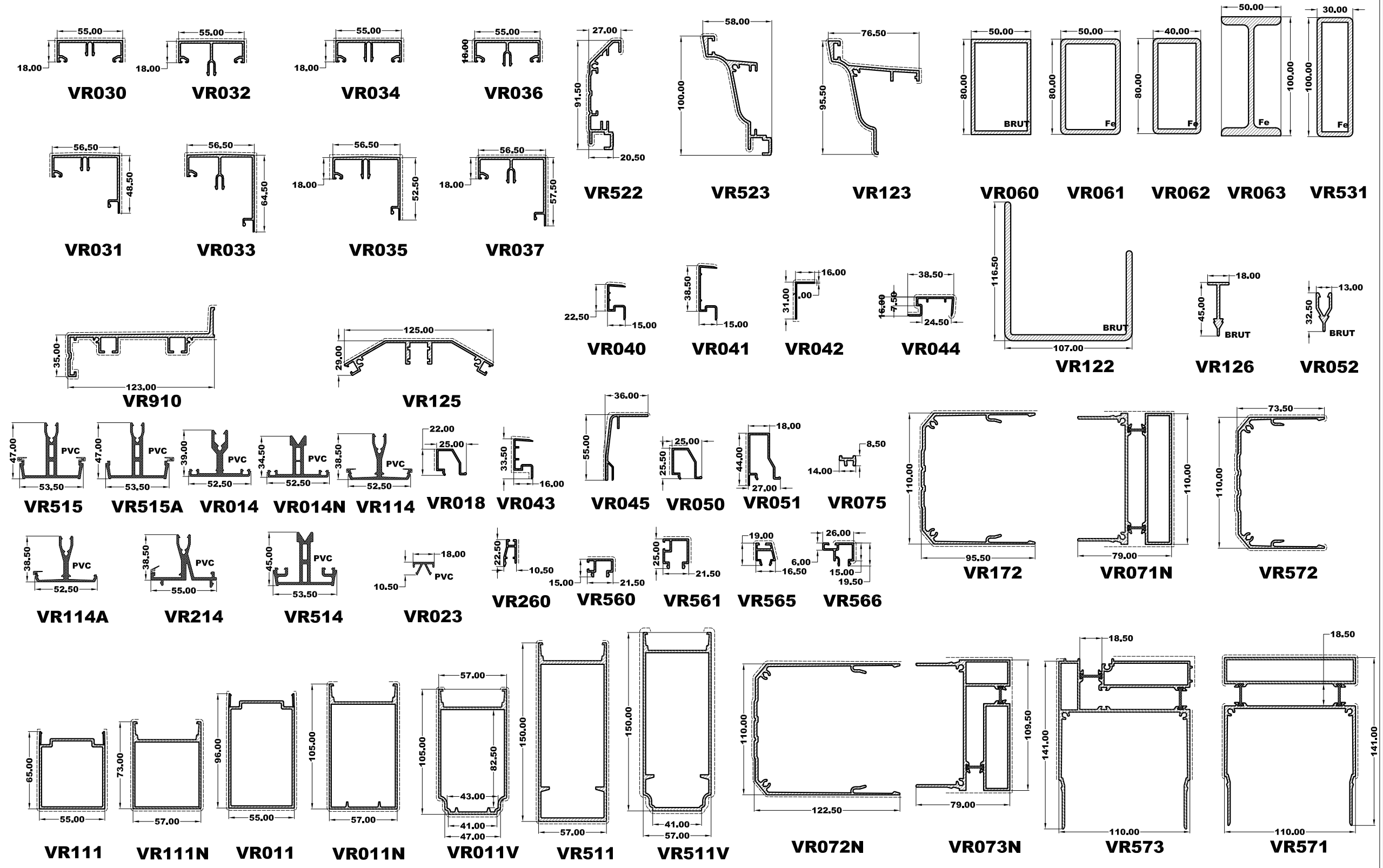

15/02/1999

TITLE

Aliver Roof - Wall Chart

smart
architectural aluminium

Smart Systems Limited
Arnolds Way, Yatton,
North Somerset,
BS49 4QN
Tel: +44 (0)1934 876 100
Fax: +44 (0)1934 835 169
www.smartsystems.co.uk

CHECKED			
PRODUCT CODE			
MATERIAL	ISSUE MOD No.	DESCRIPTION	DATE
	DRAWN	DRAWN	DRAWING No.
	DATE	JULY_2010	
	SCALE	N.T.S.@A3	

ALIVER / VR

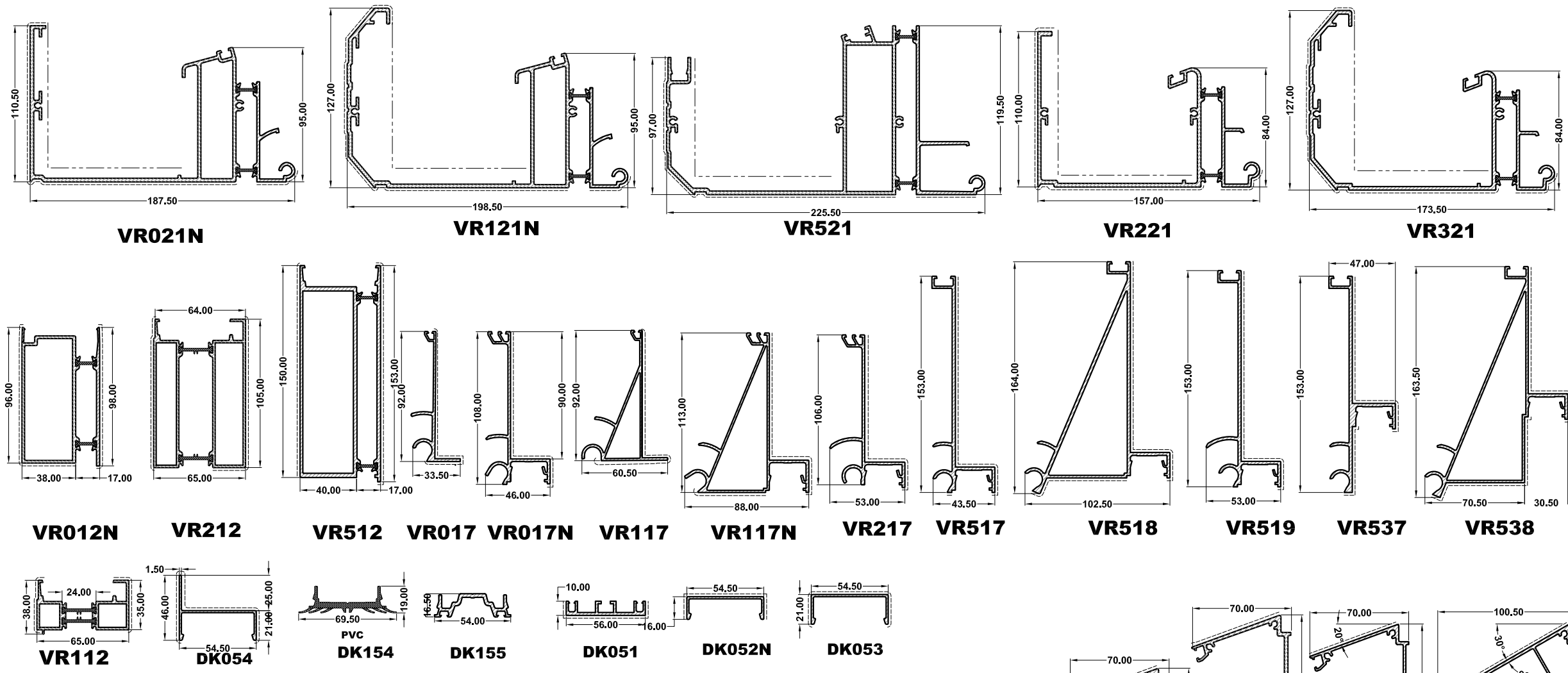

ALIVER 1000/ VR 1000

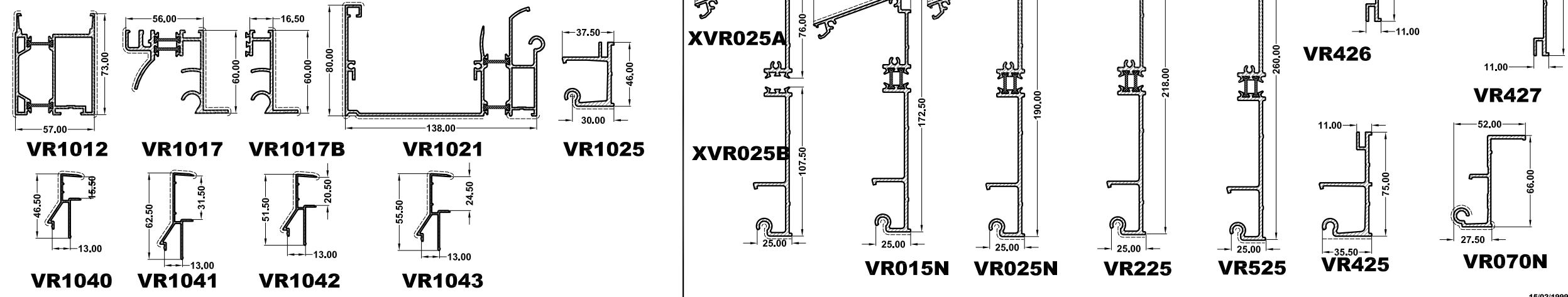

15/02/1999

TITLE

Aliver Roof / Aliver 1000 Roof - Wall Chart

smart
architectural aluminium

Smart Systems Limited
Arnolds Way, Yatton,
North Somerset,
BS49 4QN
Tel: +44 (0)1934 876 100
Fax: +44 (0)1934 835 169
www.smartsystems.co.uk

CHECKED			
PRODUCT CODE			
MATERIAL	ISSUE MOD No.	DESCRIPTION	DATE
	DRAWN	DRAWN	DRAWING No.
	DATE	JULY 2010	
	SCALE	N.T.S.@A3	

No unauthorised use, copy or disclosure of this drawing is to be made.
It is to be returned whenever required.

ISSUE	MOD No.	DATE

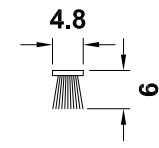
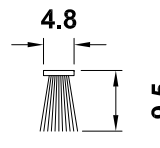
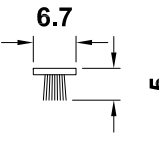
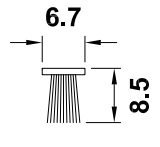
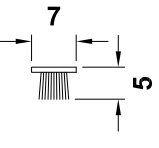
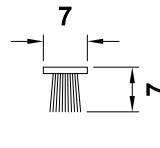
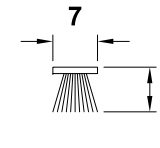
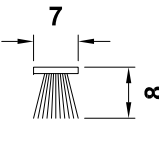
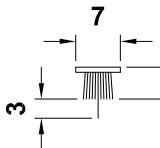
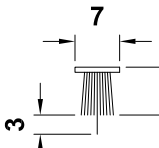
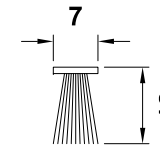
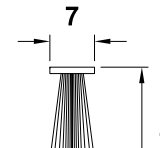
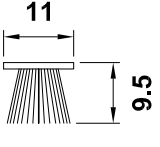
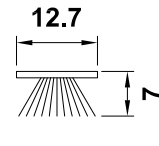
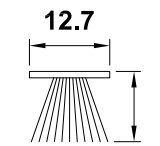
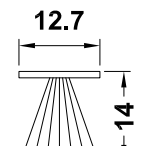
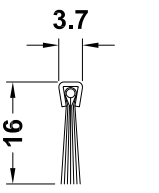
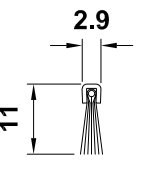
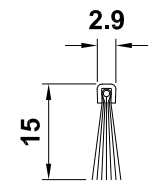
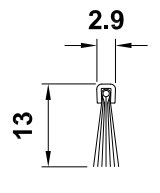
 ACSH039	 ACSH038								
 ACSH037	 ACSH035								
 ACDV205	 ACSH032	 ACSR012A	 ACVL033	 ACVG42	 ACVG22	 ACSR011	 ACDV249		
 ACDV250									
 ACIP326	 ACSR013	 ACIP325							
 ACDV201	 ACSH034	 ACSH134	 ACSH234						

TITLE

Wool Pile - Wall Chart



Smart Systems Limited
Arnolds Way, Yatton,
North Somerset,
BS49 4QN
Tel: +44 (0)1934 876 100
Fax: +44 (0)1934 835 169
www.smartsystems.co.uk

CHECKED				
PRODUCT CODE				
MATERIAL	ISSUE	MOD No.	DESCRIPTION	DATE
	DRAWN	DN		DRAWING No.
	DATE	NOVEMBER 2010		
	SCALE	N.T.S.@A3		

No unauthorised use, copy or disclosure of this drawing is to be made.
It is to be returned whenever required.

ISSUE	MOD No.	DATE

TITLE
Assessoris - Wall Chart

smart
architectural aluminium

Smart Systems Limited
Arnolds Way, Yatton,
North Somerset,
BS49 4QN
Tel: +44 (0)1934 876 100
Fax: +44 (0)1934 835 169
www.smartsystems.co.uk

CHECKED			
PRODUCT CODE			
MATERIAL			
	ISSUE	MOD No.	DESCRIPTION
	DATE	NOVEMBER 2010	
	SCALE	N.T.S.@A3	
			DRAWING No.

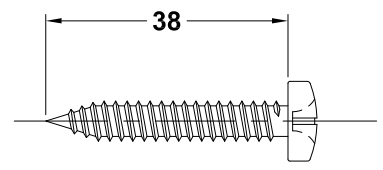
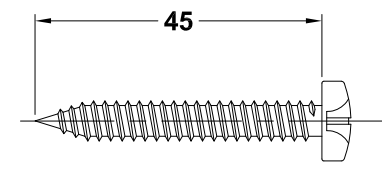
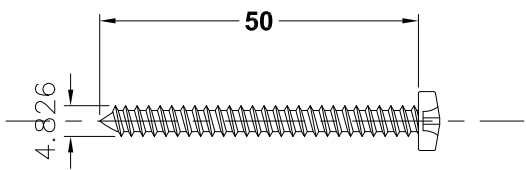
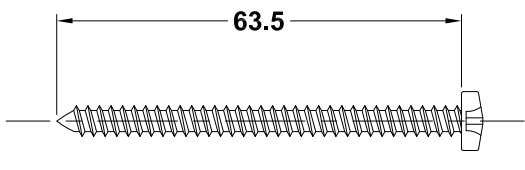
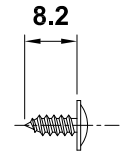
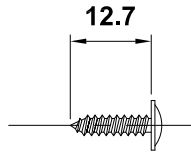
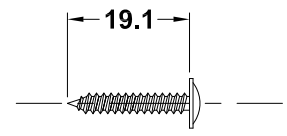
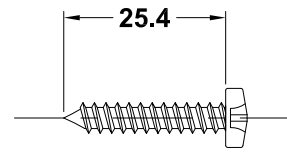
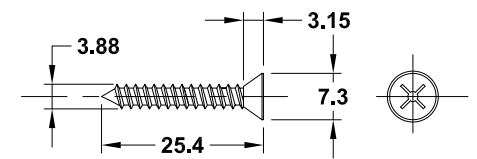
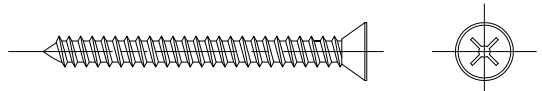
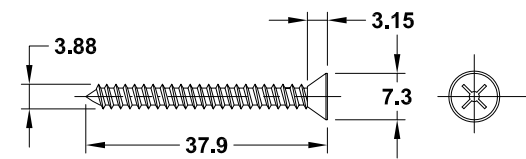
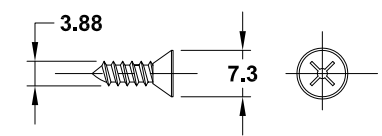
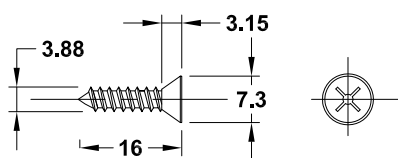
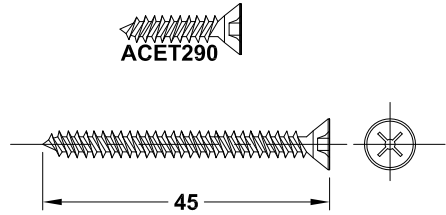
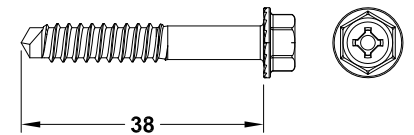
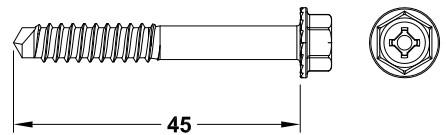
 <p>6.3 x 38</p> <p>ACMC109</p>	 <p>6.3 x 45</p> <p>ACMC110</p>	 <p>10 x 50</p> <p>ACDR052</p>	 <p>10 x 63.5 (2.5 inches)</p> <p>ACET079</p>
 <p>8 x 3/8</p> <p>ACET068</p>	 <p>8 x 1/2</p> <p>ACET070</p>	 <p>8 x 3/4</p> <p>ACET099</p>	 <p>10 x 25.4</p> <p>PUA028</p>
 <p>7 x 25.4 (1 inch)</p> <p>ACET060</p>	 <p>10 x 50.8 (2 inch)</p> <p>ACET062</p>	 <p>7 x 38</p> <p>ACET066</p>	 <p>7 x 12.7 (1/2 inch)</p> <p>ACET067</p>
 <p>8 x 5/8</p> <p>ACET064</p>	 <p>4.3 x 45 Polyamide Screw</p> <p>ACET190</p>	 <p>6.3 x 38</p> <p>ACSC005</p>	 <p>6.3 x 38</p> <p>ACSC006</p>

TITLE

Self Tappers - Wall Chart



Smart Systems Limited
Arnolds Way, Yatton,
North Somerset,
BS49 4QN
Tel: +44 (0)1934 876 100
Fax: +44 (0)1934 835 169
www.smartsystems.co.uk

CHECKED				
PRODUCT CODE				
MATERIAL	ISSUE	MOD No.	DESCRIPTION	DATE
	DRAWN	DN		DRAWING No.
	DATE	NOVEMBER 2010		
	SCALE	N.T.S.@A3		

No unauthorised use, copy or disclosure of this drawing is to be made.
It is to be returned whenever required.

ISSUE	MOD No.	DATE

TITLE

Polyamide - Wall Chart



Smart Systems Limited
Arnolds Way, Yatton,
North Somerset,
BS49 4QN
Tel: +44 (0)1934 876 100
Fax: +44 (0)1934 835 169
www.smartsystems.co.uk

CHECKED				
PRODUCT CODE				
MATERIAL	ISSUE	MOD No.	DESCRIPTION	DATE
	DRAWN	DN		DRAWING No.
	DATE	NOVEMBER 2010		
	SCALE	N.T.S.@A3		

No unauthorised use, copy or disclosure of this drawing is to be made.
It is to be returned whenever required.

ISSUE	MOD No.	DATE

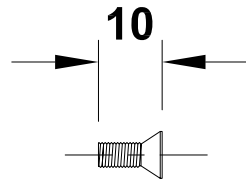

M4 x 10

ACET122

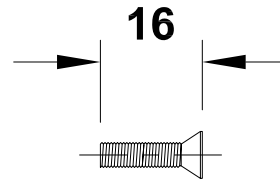

M4 x 16

ACET101

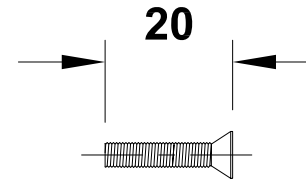

M4 x 20

ACET123

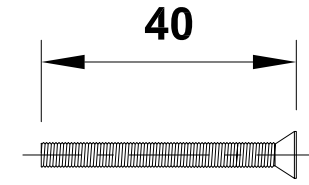

M4 x 40

ACSG071

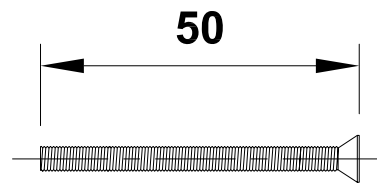

M4 x 50

ACDV262

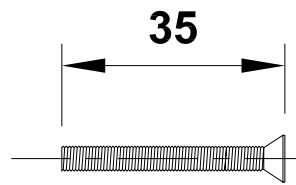

M4 x 35

ACDV264

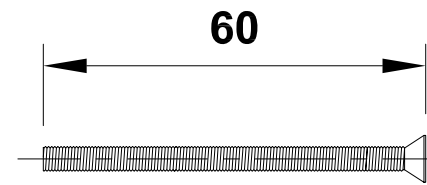

M4 x 60

ACDV265

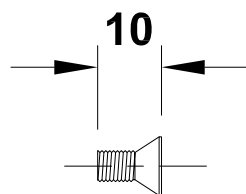

M5 x 10

ACDR051

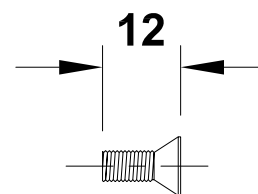

M5 x 12

ACET069

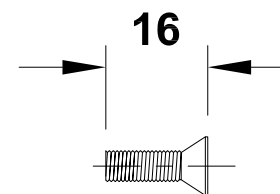

M5 x 16

HEA132

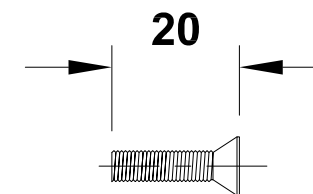

M5 x 20

WCA134

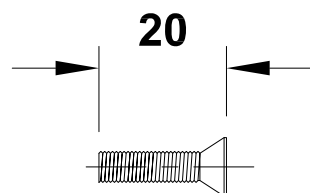

M5 x 20

WCA134

TITLE

Machine Tools - Wall Chart





Smart Systems Limited
Arnolds Way, Yatton,
North Somerset,
BS49 4QN
Tel: +44 (0)1934 876 100
Fax: +44 (0)1934 835 169
www.smartsystems.co.uk

CHECKED				
PRODUCT CODE				
MATERIAL	ISSUE	MOD No.	DESCRIPTION	DATE
	DRAWN	DN	DRAWING No.	
	DATE	NOVEMBER 2010		
	SCALE	N.T.S.@A3		

No unauthorised use, copy or disclosure of this drawing is to be made.
It is to be returned whenever required.

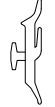
ISSUE	MOD No.	DATE

 ACDV202N - Gasket DV	 ACDV203 - Gasket	 ACVL031 - Gasket For Inside Opening	 ACVL032 - Glazing Gasket	 ACRV030 - Flipper Gasket	 ACRV031 - Head Gasket				
 ACVG231 - 2MM (Outside)	 ACVG31 - 3MM (Outside)	 ACVG131 - 4MM (Outside)	 ACET035 - 3mm Retainer						
 ACVG32 - 3MM	 ACVG33 - 4MM	 ACVG34 - 5MM	 ACVG340 - 6MM	 ACVG49 - 7MM					
 ACMC150 - Gasket For MC150	 ACMC015 - Gasket For Mullion	 ACMC016 - Gasket For Transom	 ACMC017 - Gasket For Inside Glazing	 ACMC115 - Vertical Gasket For 24MM Glazing	 ACMC116 - Horizontal Gasket For 24MM Glazing				
 ACET835 - Low line retainer	 ACET834 - Low line 4mm Wedge	 ACET836 - Long tail flipper	 ACET837 - Central seal	 ACET836 - Long tail flipper	 ACET840 - Low line 5mm wedge	 ACET841 - Low line 3mm retainer	 ACW20034 - Low line 4mm wedge		
 ACSL032 - Glazing Gasket 22 - 24MM									

TITLE

Gaskets - Wall Chart



Smart Systems Limited
Arnolds Way, Yatton,
North Somerset,
BS49 4QN
Tel: +44 (0)1934 876 100
Fax: +44 (0)1934 835 169
www.smartsystems.co.uk

CHECKED				
PRODUCT CODE				
MATERIAL	ISSUE	MOD No.	DESCRIPTION	DATE
	DRAWN	DN	DRAWING No.	
	DATE	NOVEMBER 2010		
	SCALE	N.T.S.@A3		

No unauthorised use, copy or disclosure of this drawing is to be made.
It is to be returned whenever required.

ISSUE	MOD No.	DATE

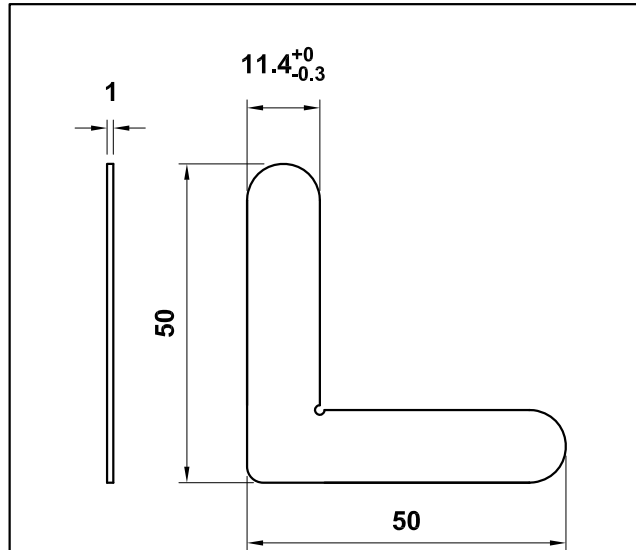

ACDV21

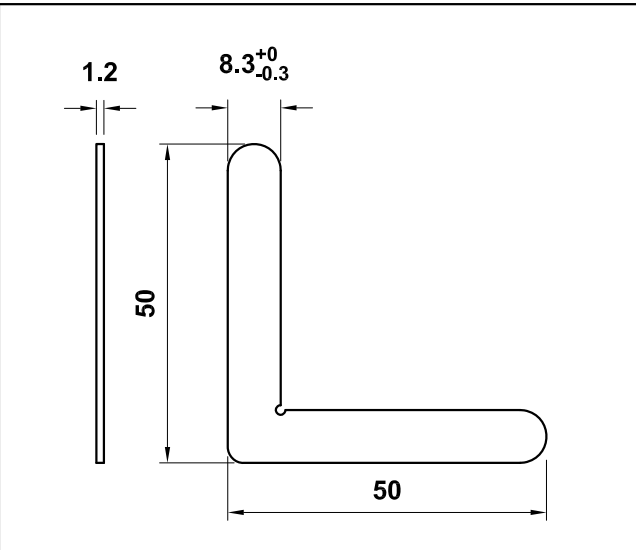

ACDV24

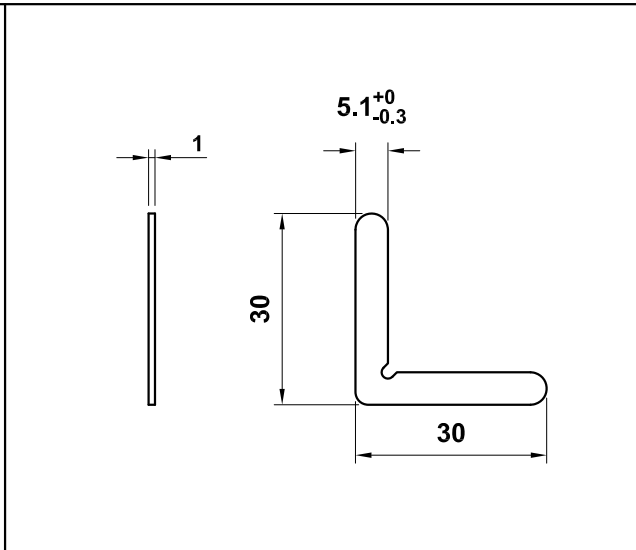

ACET044

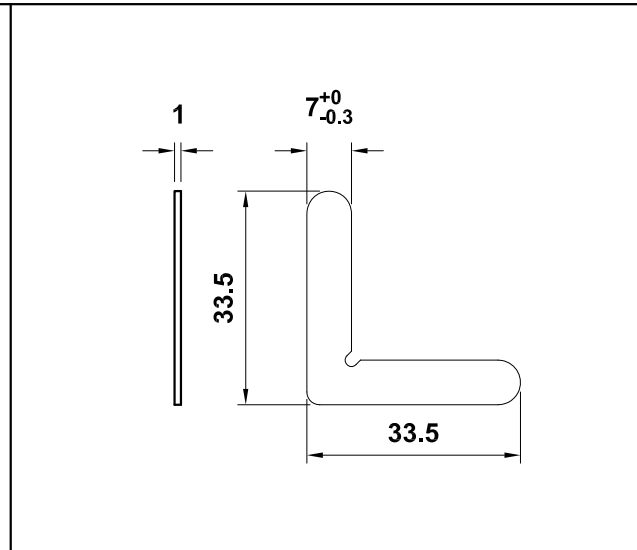

ACET045

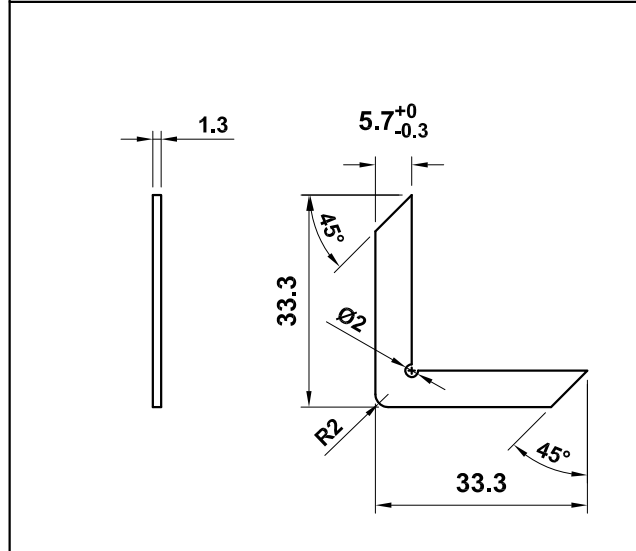

ACET115

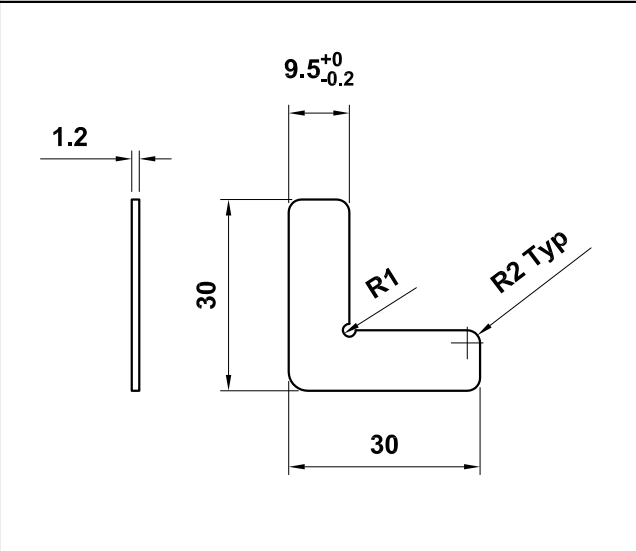

ACET171

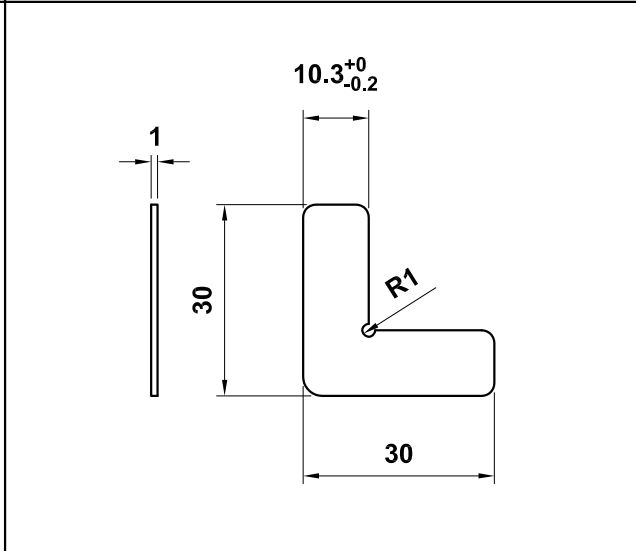

WUA106

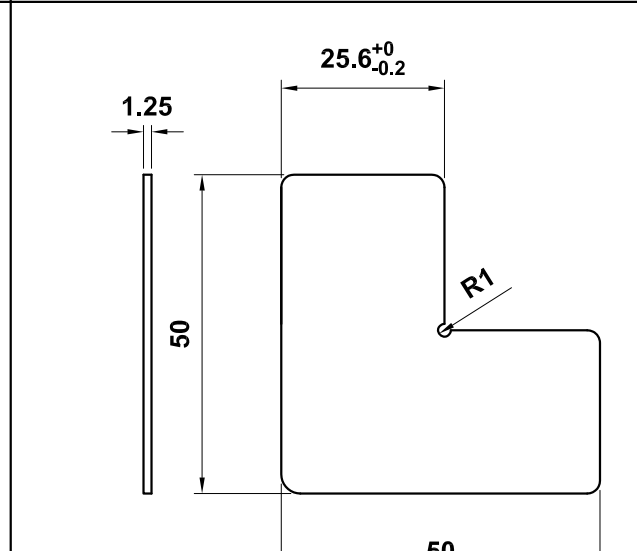

ACET055

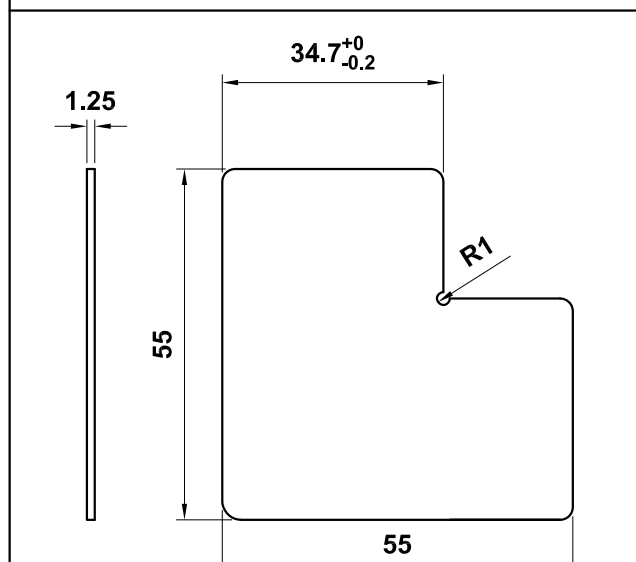

ACET154

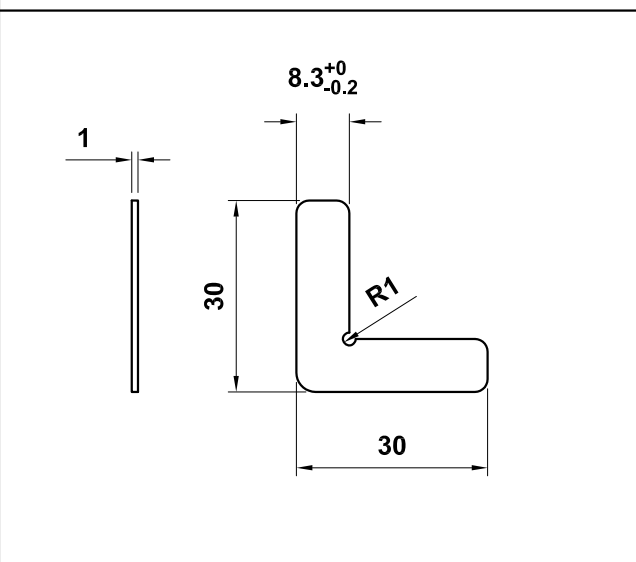

ACW20024

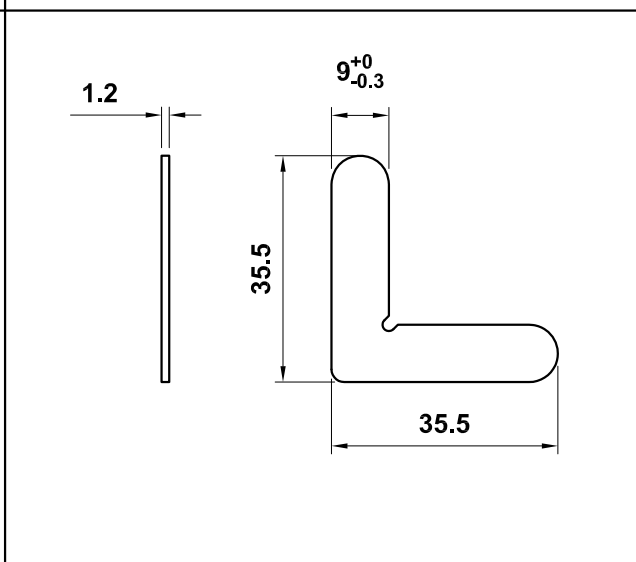

ACET822

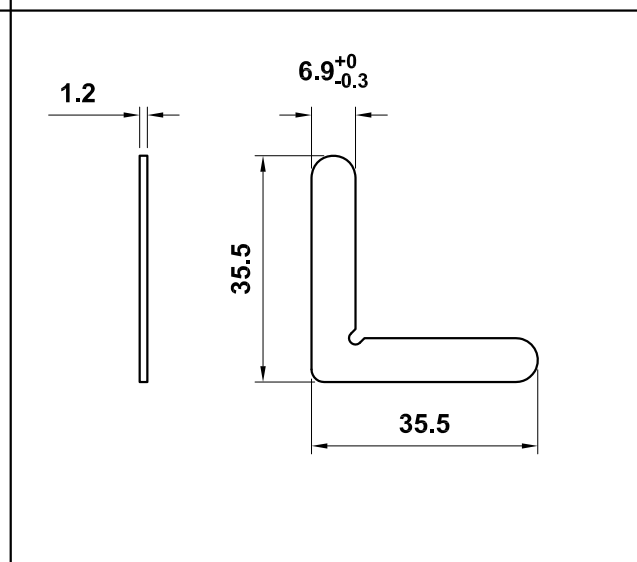

ACET823

TITLE

Chevrons - Wall Chart



Smart Systems Limited
Arnolds Way, Yatton,
North Somerset,
BS49 4QN
Tel: +44 (0)1934 876 100
Fax: +44 (0)1934 835 169
www.smartsystems.co.uk

CHECKED				
PRODUCT CODE				
MATERIAL	ISSUE	MOD No.	DESCRIPTION	DATE
	DRAWN	DN		DRAWING No.
	DATE	NOVEMBER 2010		
	SCALE	N.T.S.@A3		

GSL1155
35mm Head
Extension

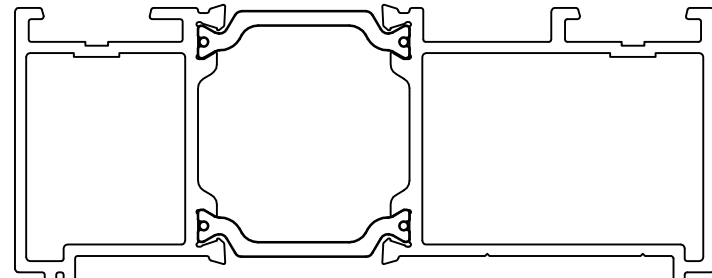

GSL1110
Head Section

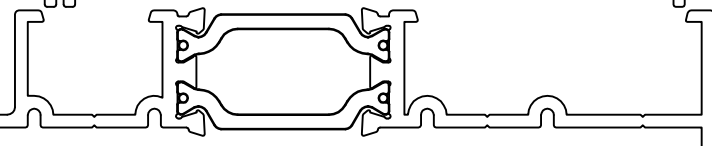

GSL1140
Head Guide Section

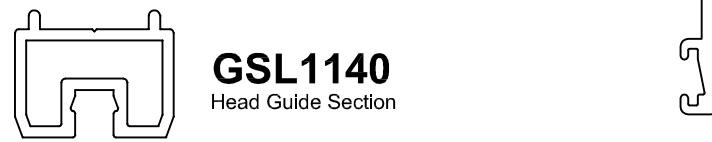

GSL1111
Jamb Section

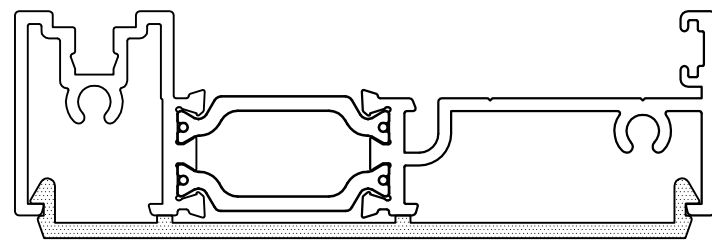

GSL1145
External Jamb PVC Clip Plate



GSL1114
Jamb Section
To Conceal Woolpile

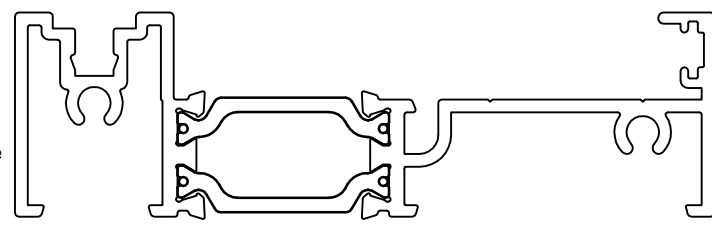

GSL1160

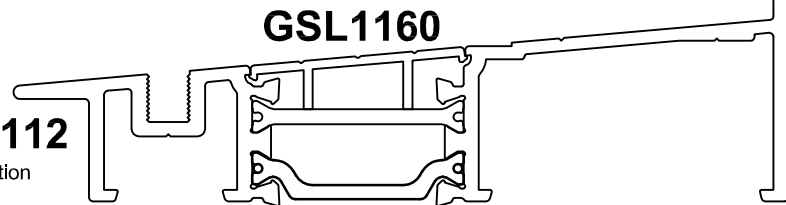

GSL1112
Cill Section

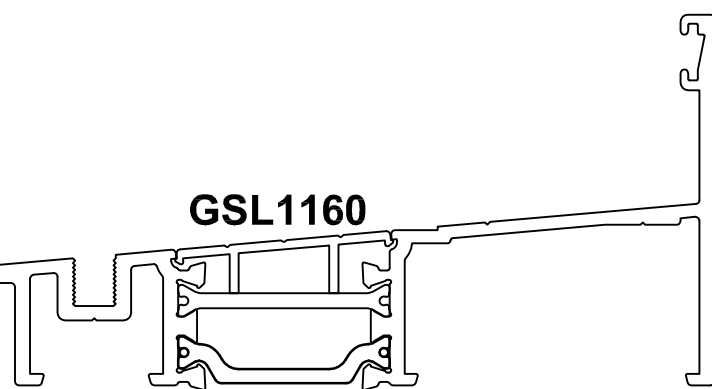

GSL030
70mm Mid-Rail

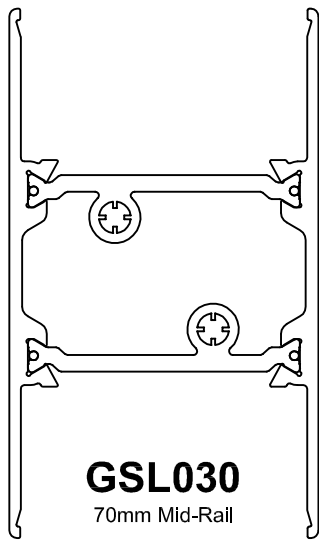

GSL1120
Sash Section

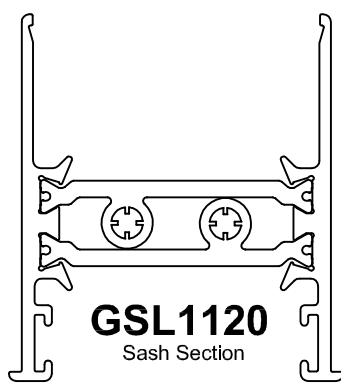

GSL1130
Letter Plate
Mid-Rail

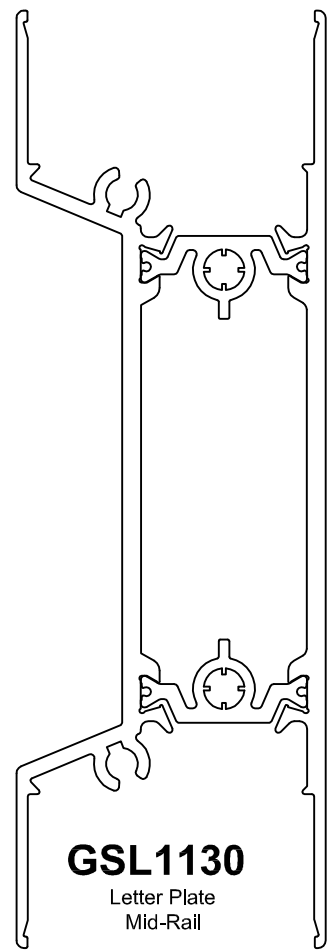

GSL1131
124mm
Mid-Rail

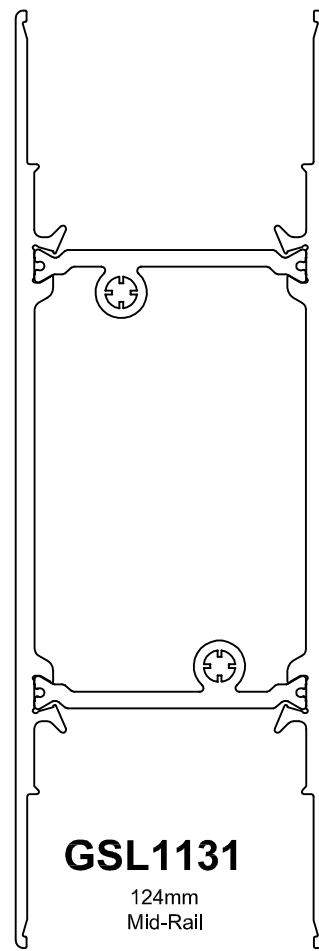

GSL310
Interlock

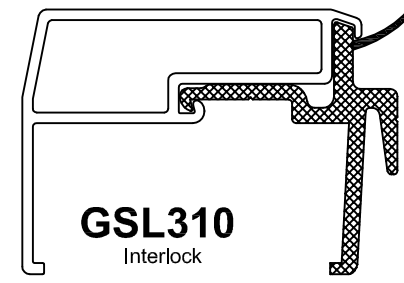

GSL1330
Interlock

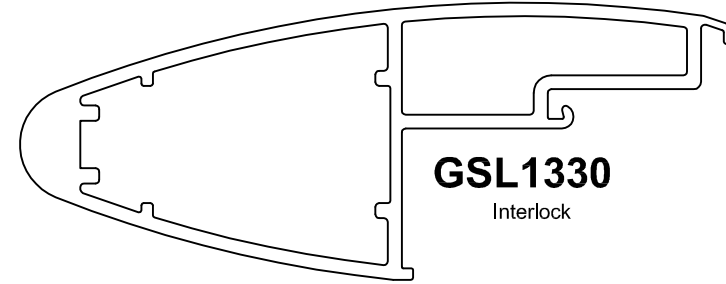

GSL1335
Interlock

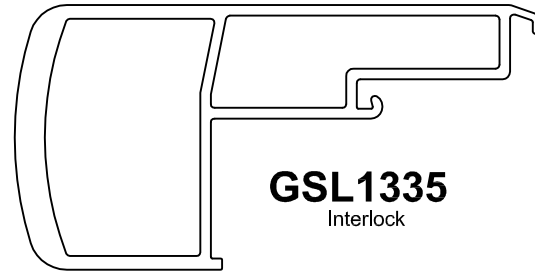

GSL053
PVC Interlock

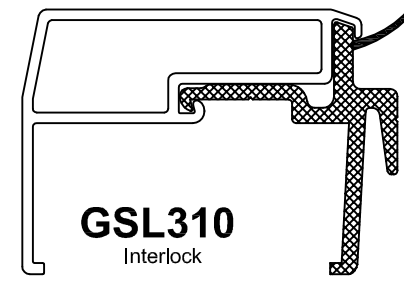

GSL1121
Fixed Stile

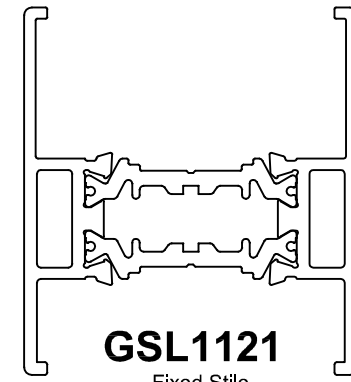

GSL1157
10mm Outer Jamb/Head Extension



GSL1158
10mm Outer Jamb/Head Extension

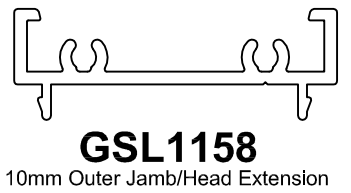

GSL1333
Three Pane Adaptor

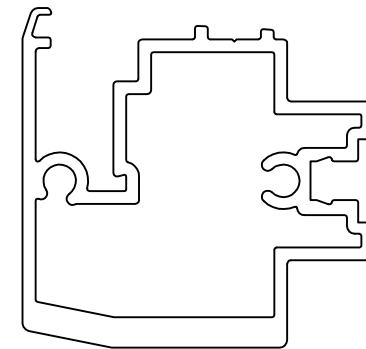

GSL022
Locking Stile

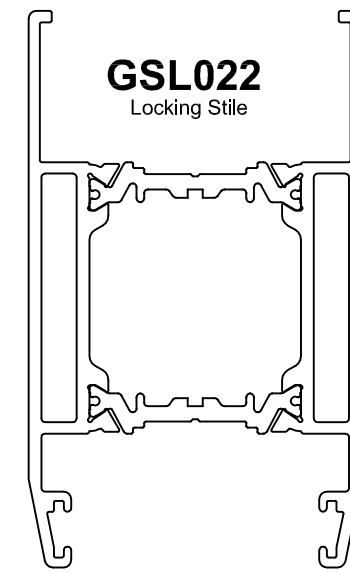

GSL1141
Internal Head Clip Plate



GSL1142
Internal Jamb Clip Plate

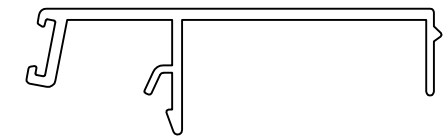

GSL1143
External Jamb Clip Plate



GSL1144
Internal Cill Clip Plate

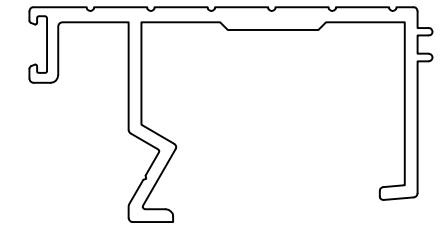

GSL1148
Internal Cill Clip Plate
with Double Woolpile Carrier

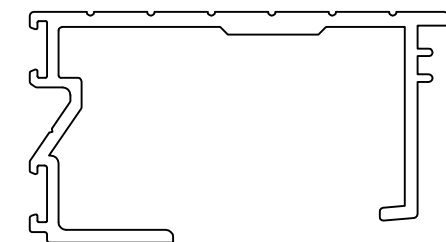

GSL1149
External Jamb Clip Plate
To Conceal Woolpile

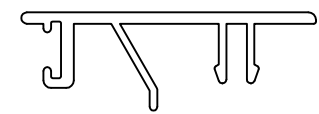

GSL1150
Internal Jamb Clip Plate
for GSL1114

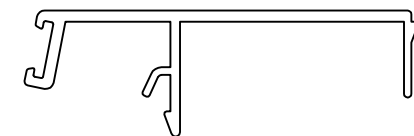

VG53
Stainless Steel Track



VG52
PVC Infill



GSL1146
Sash Weather Drip

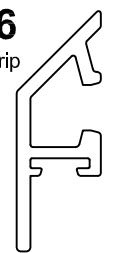

GSL1147
Cill Security Strip

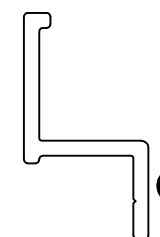

smart
architectural aluminium

DRAWING No.	Slide Mono Rail
Please refer to the technical manual for additional sections & information	
no unauthorised use, copy or disclosure of this drawing is to be made.	

GSL1010

Two Track
Outer Frame

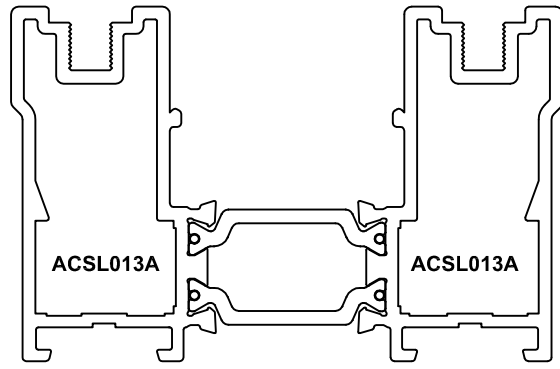

GSL1012

Three Track
Outer Frame

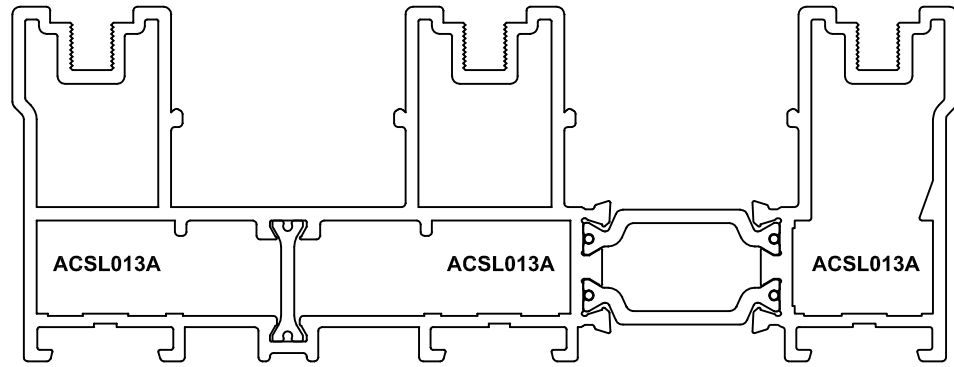

GSL1014

GSL1010/GSL1012
Track Cover

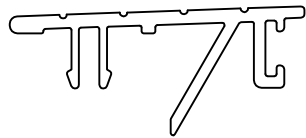

GSL1015

GSL1012
Track Cover

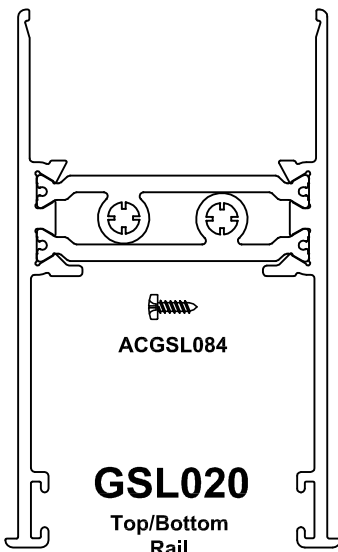
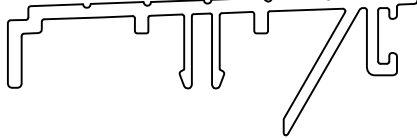

GSL020
Top/Bottom
Rail

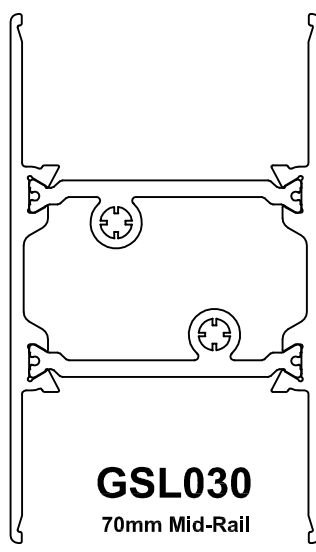

GSL030
70mm Mid-Rail

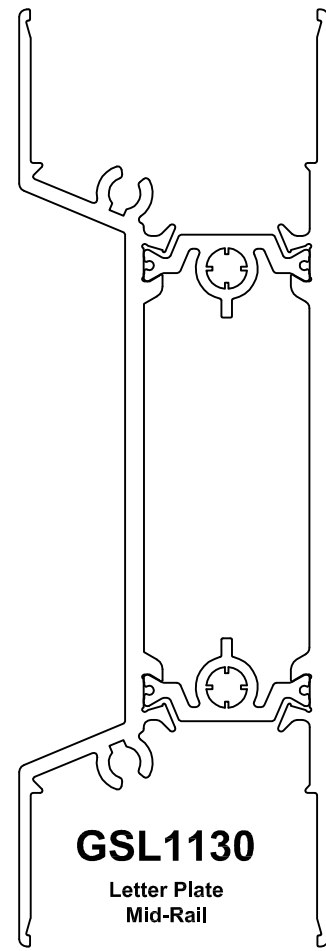

GSL1130
Letter Plate
Mid-Rail

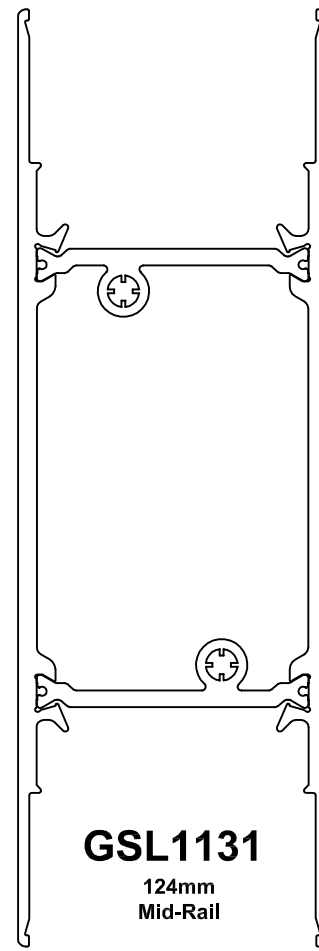

GSL1131
124mm
Mid-Rail

GSL050
Channel Infill

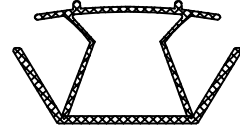

GSL051
Cill Channel Infill

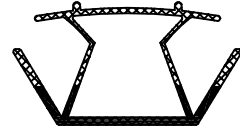

GSL040

Meeting Stile Adaptor

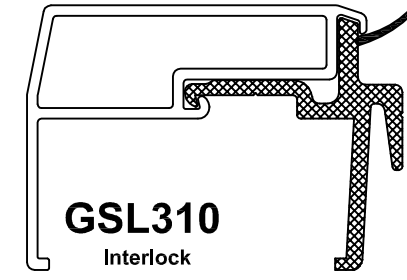
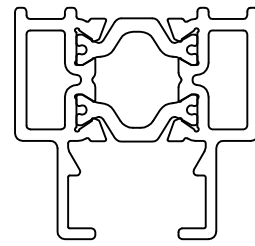

GSL310
Interlock

GSL053
PVC Interlock

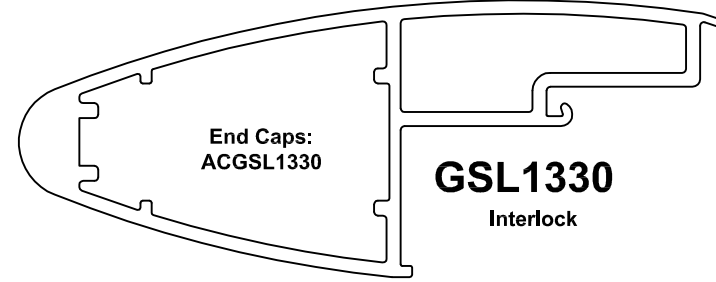

GSL1330
Interlock

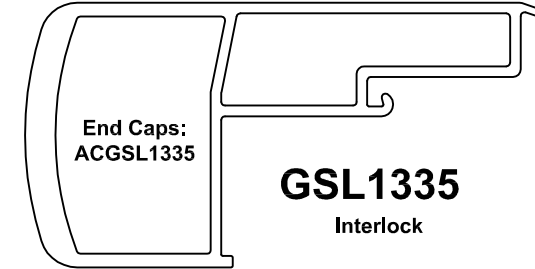

GSL1335
Interlock

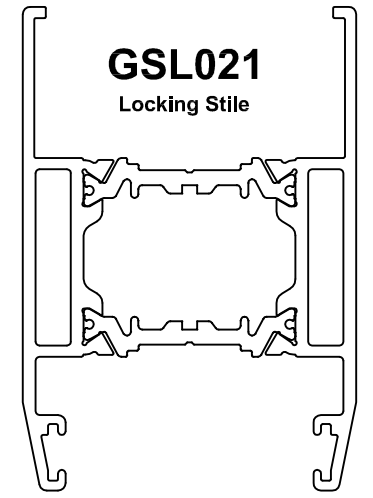

GSL021
Locking Stile

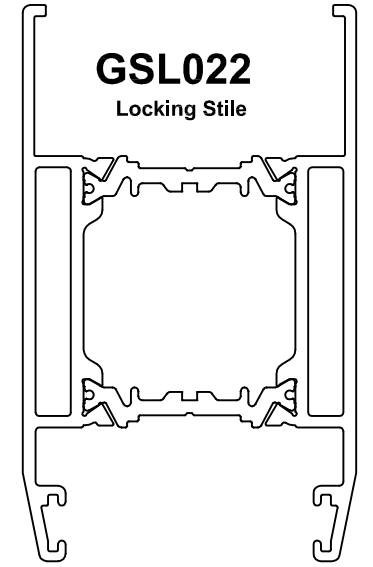

GSL022
Locking Stile

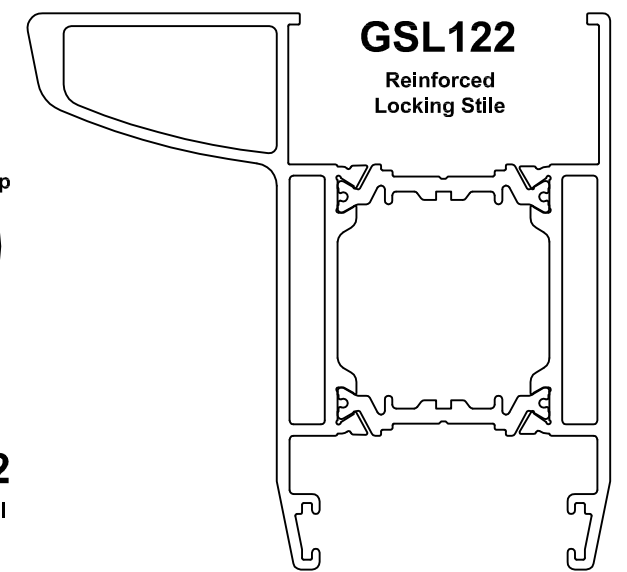

GSL122
Reinforced
Locking Stile

VL72
Weather Drip



VL75
Weather Drip

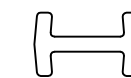

VG53
Stainless Steel Track



VG52
PVC Infill



VS011
Head Section

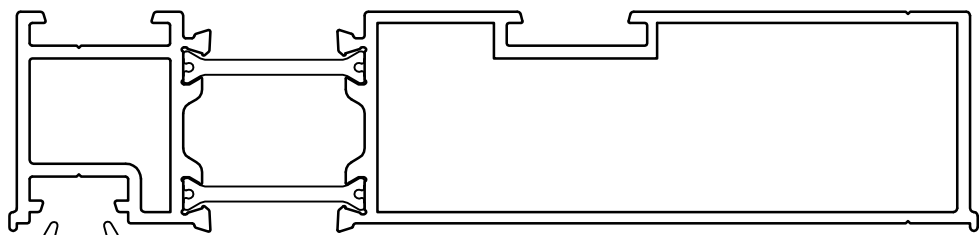

VS041
External Woolpile
Carrier

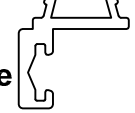

VS012
Jamb Section

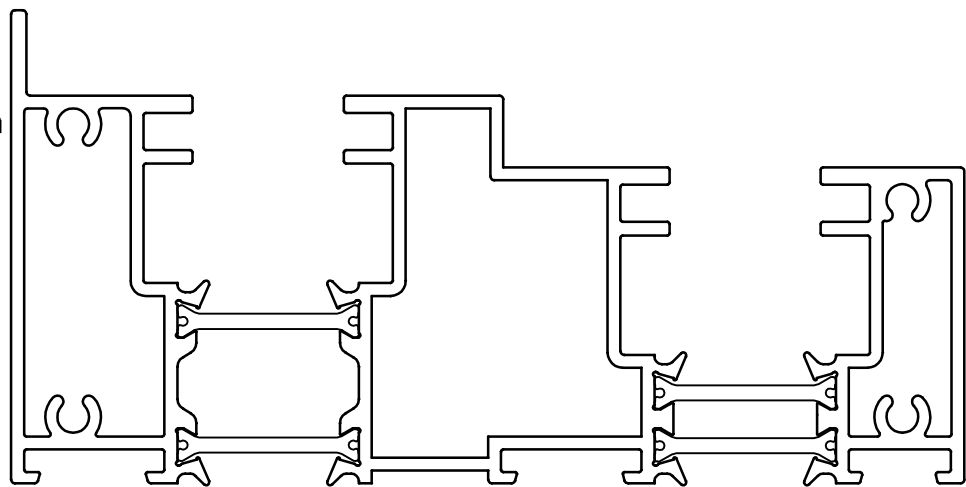

VS112
Slim
Jamb Section

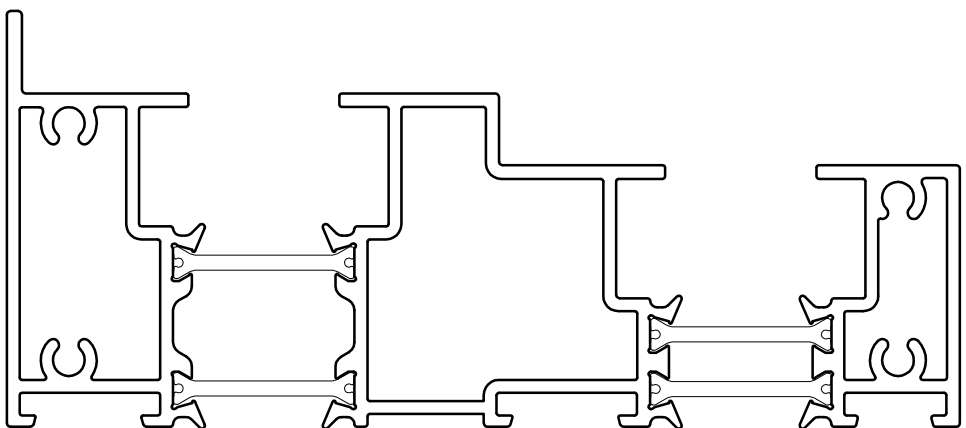

VS010
Flush Cill
Section

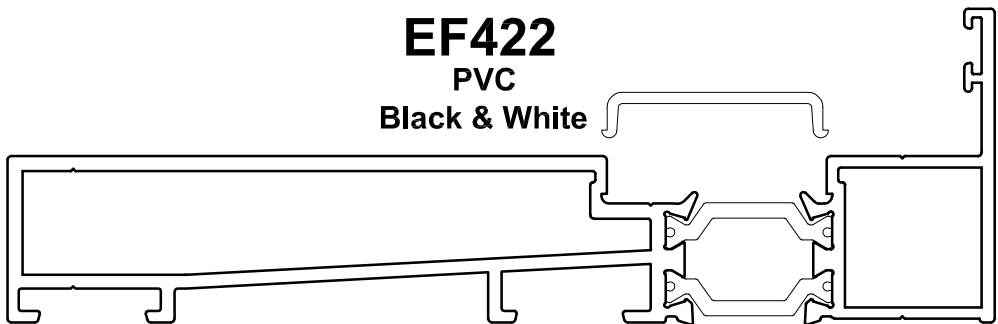

VS110
180mm Cill
Section

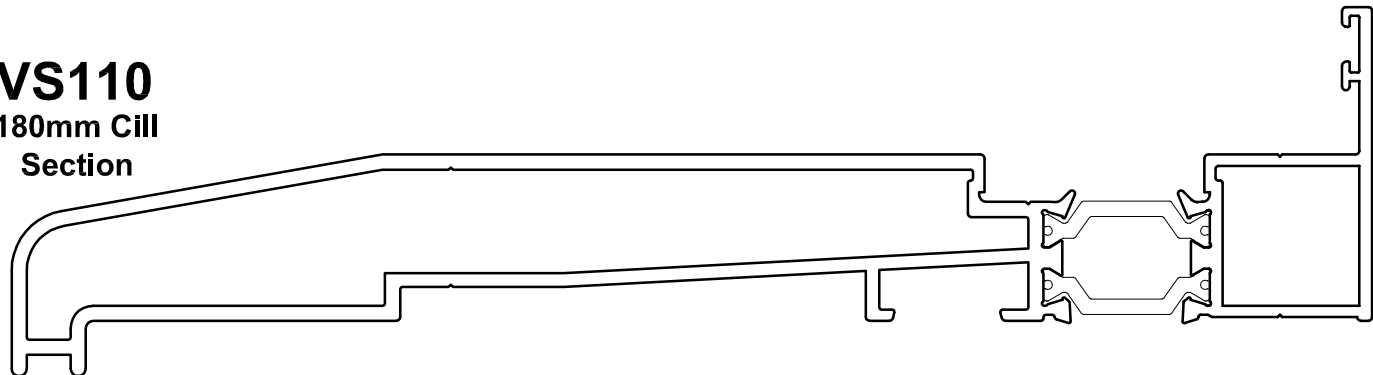

EF422
PVC
Black & White

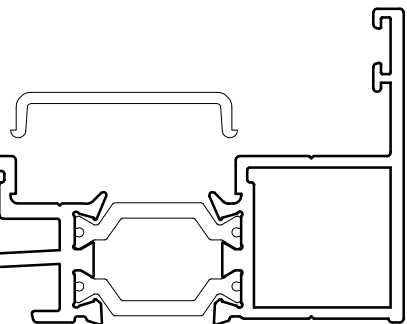

VS020
Top Rail of Top Sash &
Bottom Rail of Bottom Sash

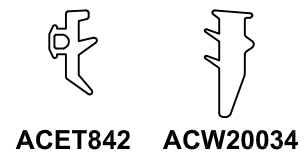
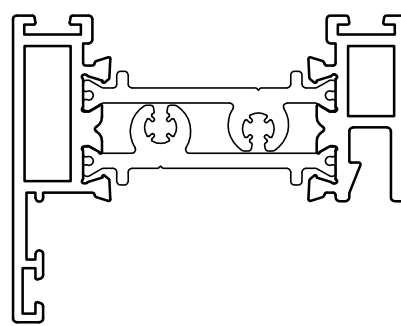

ACET842 ACW20034

VS030N
Stepped
Interlock Cap

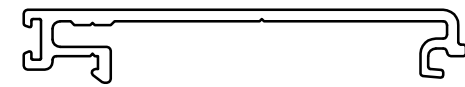

VS130
Flush
Interlock Cap

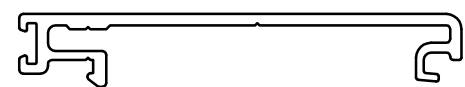

VS021
Bottom Rail
of Top Sash

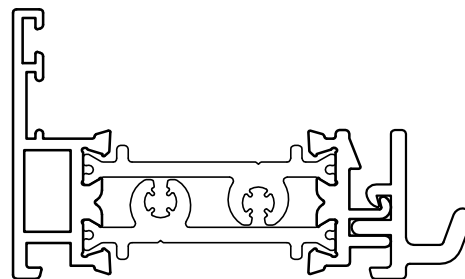

VS031
External Interlock
PVC
Black Only

VS045
Internal Bead
(28mm Units)

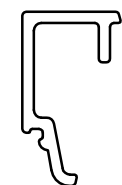

VS032
Internal Interlock
PVC
Black Only

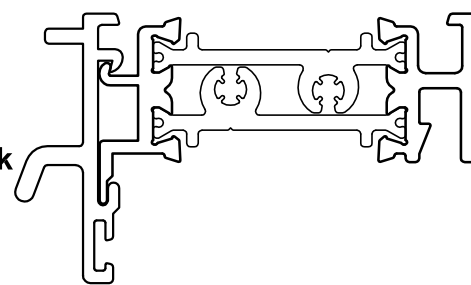

VS022
Top Rail
of Bottom Sash

VS046
External Bead
(28mm Units)



VS023
Stepped
Vertical Member
of Bottom Sash

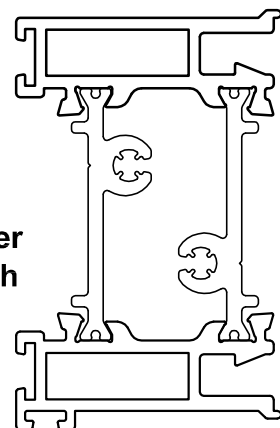

VS123
Flush
Vertical Member
of Bottom Sash

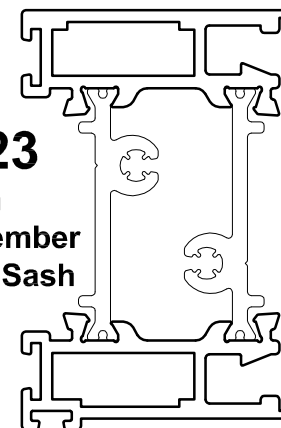

VS025
Deep Bottom Rail
of Bottom Sash

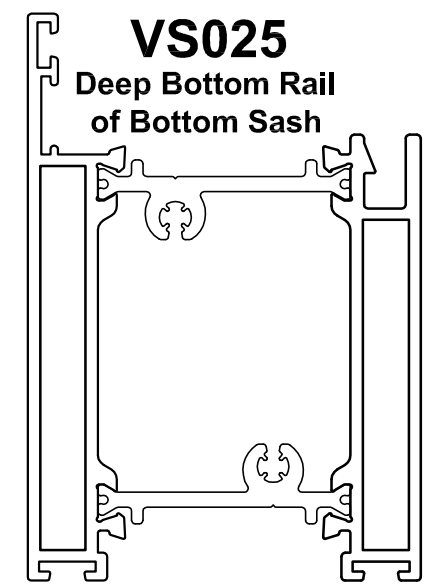

VS024
Stepped
Vertical Member
of Top Sash



VS124
Flush
Vertical Member
of Top Sash

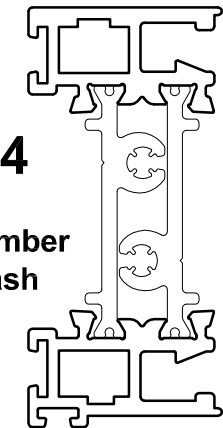

DRAWING No.
Vertical Slider

no unauthorised use, copy or
disclosure of this drawing is to be made.